

EZ FOLD Wall Mount Hinged Bracket, 2 RMS

PRODUCT SPECIFICATION

Package includes:

- A. Folding Wall Mount Hinged Bracket, 1 pc
- B. #12-24 UNC x $\frac{5}{8}$ "⁵, Black Oxide, Pan Head, Combination Drive, Pilot Point, Machine Screw, 8 pcs
- C. Installation Instructions, 1 pc

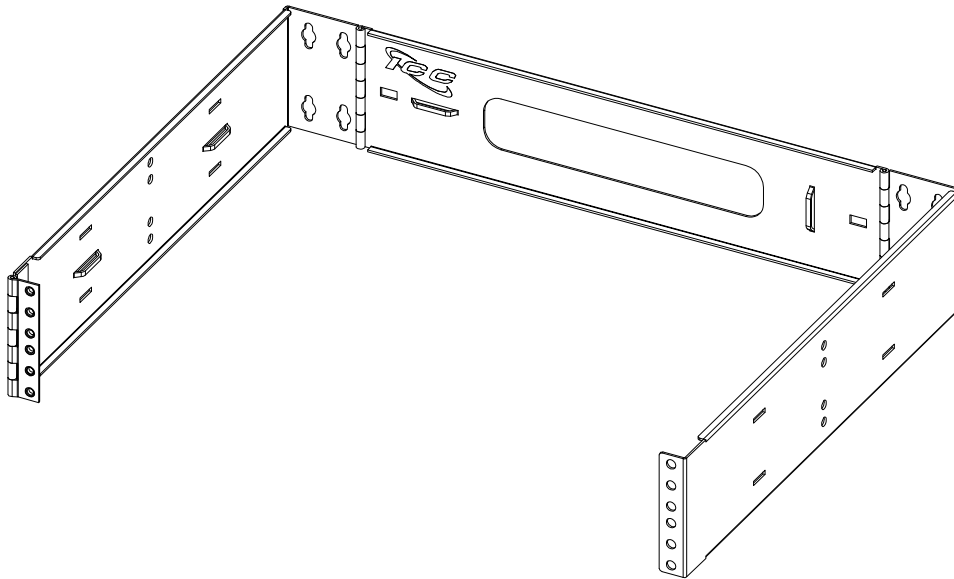

Features and Benefits:

- Designed with high quality steel and black powder coating.
- Designed with a 15" depth making it ideal for installing voice and data equipment such as patch panels, light weight active components, shelves, drawers, and cable management products creating an organized system.
- Up to 30 lbs weight capacity when properly secured to surface.
- Divided hinge allows easy access for upgrades and maintenance.
- Ideal for installations with space restrictions.
- 2 rack mount space (RMS).
- Compatible with EZFOLD enclosure kit ICCMSABRSC.



BRACKET, WALL MNT, EZ-FOLD, 2 RMS



ITEM NO.	ICCMSABRS2
DWG NO.	PSCMSABRS2

REV.	A
PAGE NO.	1

888-ASK-4-ICC (275-4422) * CSR@ICC.COM * WWW.ICC.COM

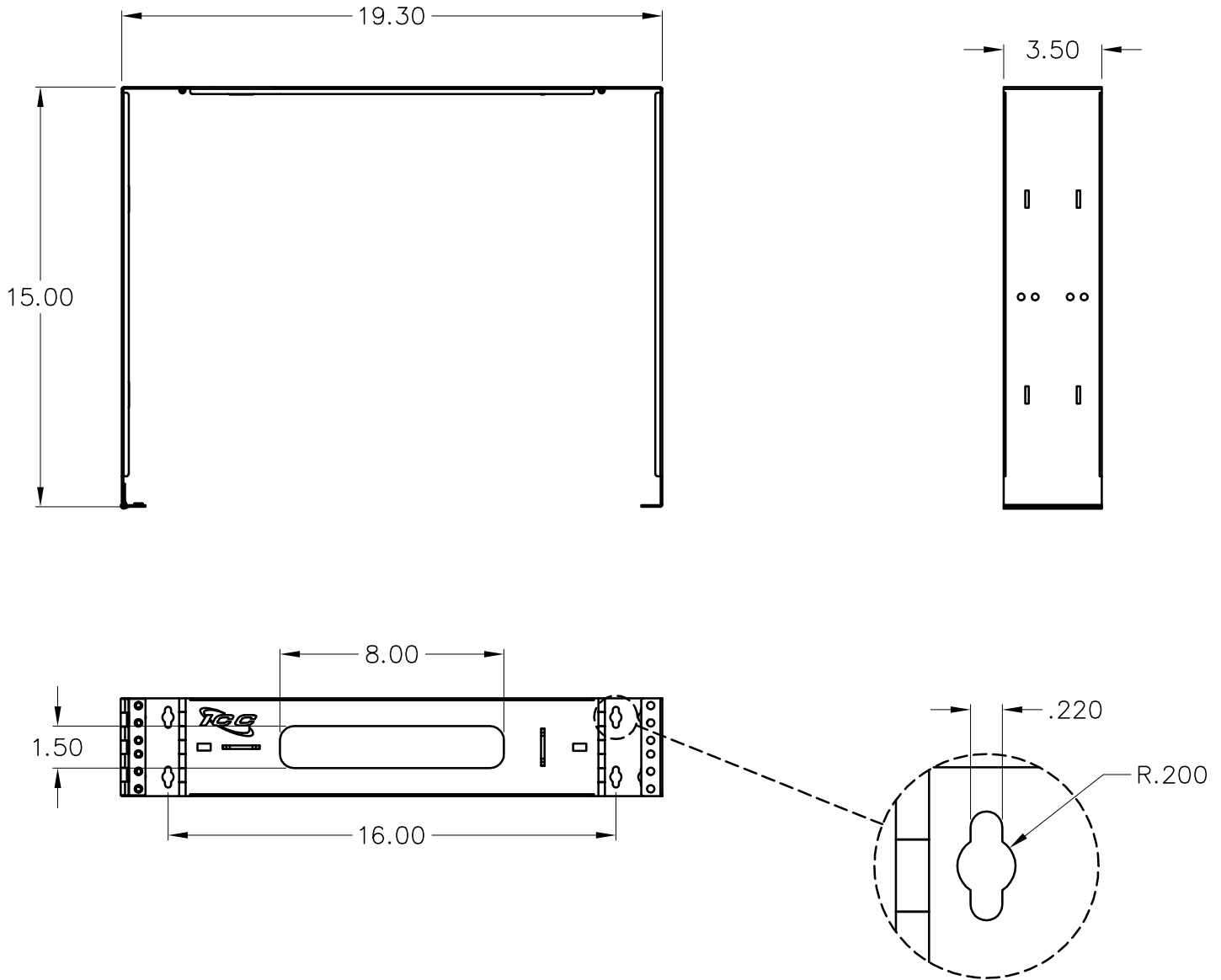

NOTE: UNLESS OTHERWISE SPECIFIED

1. MATERIAL: 16 GA CRS
2. FINISH: BLACK POWDER COAT
3. EIA-310-D COMPLIANT



BRACKET, WALL MNT, EZ-FOLD, 2 RMS



ITEM NO.	ICCMSABRS2	REV.	A
DWG NO.	PSCMSABRS2	PAGE NO.	2

888-ASK-4-ICC (275-4422) * CSR@ICC.COM * WWW.ICC.COM