

Hubbell Floor Boxes

Featuring Hubbell SystemOne Floor Boxes

HUBBELL



SystemOne 4x4



SystemOne Multimedia



Traditional Recessed



Traditional Flush



Sold by:



<http://www.TWAcomm.com>
Toll Free: (877) 389-0000

Nobody delivers like Hubbell Commercial Solutions



Wiring Systems

Hubbell Floor Boxes

Featuring the unique capabilities of Hubbell's SystemOne universal cover and sub-plate design, Hubbell has expanded its floor box offering to provide industry leading flexibility while accommodating an extensive range of applications. Hubbell SystemOne is constructed to give customers the ability to create personal solutions for their most demanding, power, data and audio/video requirements. In addition, Hubbell continues to offer a complete variety of traditional flush and recessed floor box options.

Whatever your requirement, Hubbell has a solution. Combined with Hubbell SystemOne fire-rated poke-through products that offer the same unique advantages, Hubbell's entire delivery system package is second to none in providing a consistent aesthetic and functional solution for your power, data and audio/video needs.



Hubbell SystemOne Floor Box applications...



Multi-Service Applications

This Hubbell SystemOne sub-plate incorporates 2 standard Style Line® rectangular openings. These can be used for a variety of power and/or data applications. It will accommodate 15 or 20 amp, standard, isolated ground, GFCI or surge protected receptacles. Using communication frames it can provide up to a 6-port multi-service or a 12-port all communication solution.

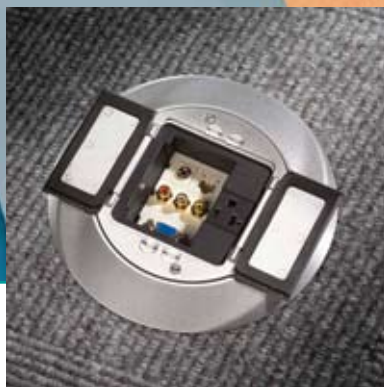

Multimedia Applications

Other Hubbell SystemOne sub-plates are designed to meet the growing needs of the audio and video markets. Some sub-plates provide power outlets with Hubbell's audio/video products including 15-Pin SVGA, RCA, S-Video, 3.5mm stereo, and XLR microphone jacks. Another sub-plate can accommodate Extron® Electronics's MAAP and AAP series audio/video modules.



4X4 Applications

Provides maximum power capacity for flush, multi-service applications. This sub-plate features a pre-wired four outlet 20A, 125V receptacle and four openings for snap-in flush mount Hubbell modular jacks and audio/video snap-in connectors.

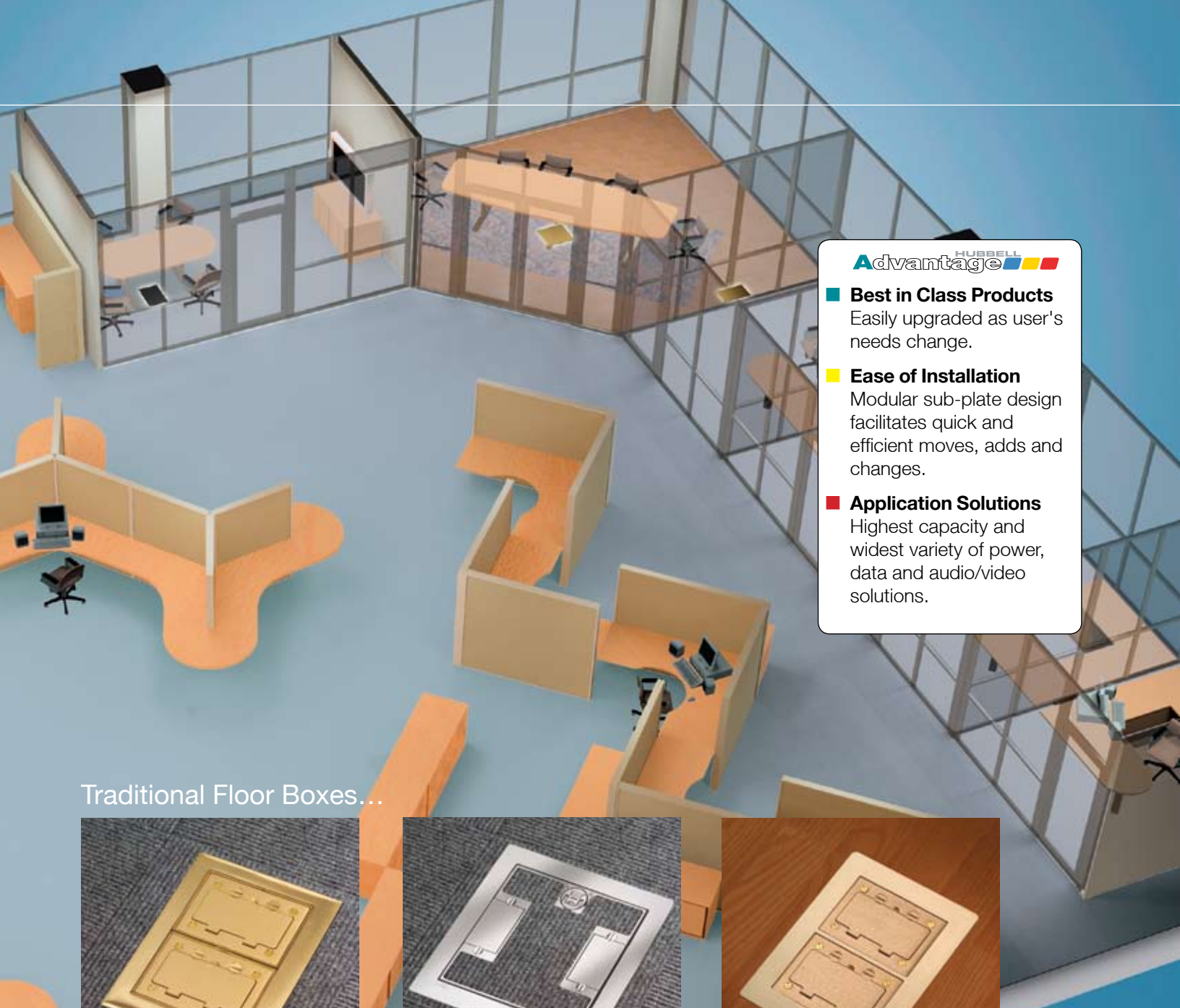

Advantage HUBBELL

- **Best in Class Products**
 Easily upgraded as user's needs change.
- **Ease of Installation**
 Modular sub-plate design facilitates quick and efficient moves, adds and changes.
- **Application Solutions**
 Highest capacity and widest variety of power, data and audio/video solutions.

Traditional Floor Boxes...

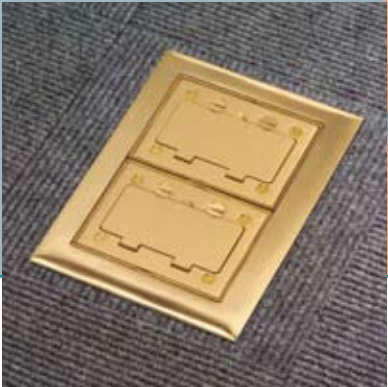

Flush Applications
 Hubbell offers a wide variety of traditional solutions including single and multi-gang cast iron, stamped steel and non-metallic floor boxes in both round and rectangular designs. These boxes can be finished with either brushed brass or aluminum covers and flanges to match any office décor. All Hubbell floor box assemblies exceed UL 514A scrub water exclusion requirements.



Recessed Applications
 For applications where recessed connections are desired, Hubbell has a complete line of recessed stamped steel and cast iron floor boxes, from two to eight gangs. A variety of modular face plates are available to meet a wide array of power, data, voice and audio/video requirements. Carpet and tile cover/flange assemblies are offered in painted brass, aluminum, black, gray, brown and ivory colors.

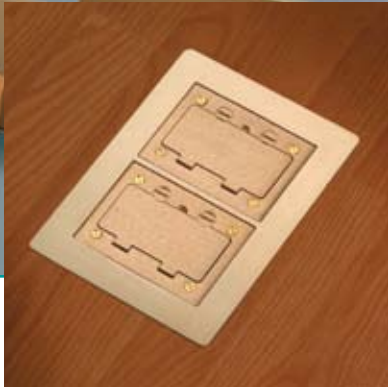

Wooden Floor Applications
 Hubbell offers round, single service and rectangular, multi-service floor boxes for wooden floor applications. The rectangular boxes are available in one, two and three-gang options and feature removable barriers for maximum capacity while maintaining separation of power and low voltage. A variety of covers and flanges are available in brushed aluminum or brass to meet aesthetic requirements.

Hubbell SystemOne Non-Metallic Floor Box



Saves time and money on installation with a simple saw cut after pour adjustment.

Oversized 1 1/2" data conduit hub provides for increased cable capacity and helps maintain proper bend radius suitable for Category 6/6a, 5e, coax and fiber cables.

Parallel conduit hubs reduce labor and material costs and facilitate easier wire pulling in dual-service applications.

- Provides an economical, easy to install in-floor delivery system for large, open plan spaces.
- Accepts all Hubbell SystemOne universal covers and sub-plates for both single and dual service applications.
- Convenient cubic inch capacity markings on inside allow for easy inspection.
- Corresponding graduated cubic inch markings on dividers.
- High-strength rigid PVC construction that is non-corrosive.
- Supplied with concrete cap, conduit reducers, and conduit hub plugs.

Hubbell SystemOne Universal Cover

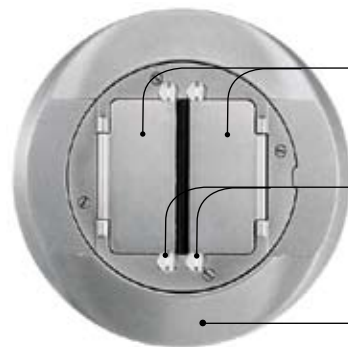

Hinged doors open 180 degrees flush to the carpet flange or tile.

Screws allow each door to be secured independently.

Universal carpet or tile flange can be used for Hubbell SystemOne Fire-Rated Poke-Through or PVC Floor Box.

- Cast aluminum construction available in durable black, gray, brass, aluminum and ivory powder coat finishes.
- Features ScrubShield™ technology that exceeds UL514A and UL514C scrub water exclusion requirements.
- Provides consistent look and maximum functionality throughout the installed life.







Hubbell SystemOne Sub-Plates

While no one can predict the future, Hubbell's modular sub-plate design allows users to economically upgrade Hubbell SystemOne Floor Boxes to accommodate future moves, adds and changes.



- Hubbell 4X4: four 20A, 125V receptacles, four openings for voice/data jacks and multimedia connectors.
- Hubbell INFINESTATION™ front loading modular connectivity.
- Accommodates Extron® Electronic's Architectural Series audio/video system integration products.
- Ortronics®, Siemon™, Panduit®, SYSTIMAX® and keystone options enable maximum data flexibility.
- Large capacity and multi-service furniture feed applications.
- Accommodates GFCI, surge and standard Style Line® receptacles.
- Twist-Lock® receptacle with or without jack openings.

Flush Rectangular Stamped Steel Floor Boxes

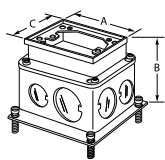
Box Material	Stamped Steel					
Collar Material	B2431 BA2431	B2432 BA2432	B2433 BA2433	B2421 BA2421	B2422 BA2422	B2423 BA2423
Brass						
Aluminum						
						
Min. Depth of Pour	3.75"	3.75"	3.75"	2.75"	2.75"	2.75"
Adjustability (Fully, Semi, Non)	Fully	Fully	Fully	Fully	Fully	Fully
Before Pour External Height Adjustment	1.25"	1.25"	1.25"	1.25"	1.25"	1.25"
After Pour Internal Height Adjustment	.50"	.50"	.50"	.50"	.50"	.50"
Cubic Inch Capacity	60.00	52.80 Per Gang	50.80 Per Gang	39.50	35.00 Per Gang	34.00 Per Gang
Dimensions - A	4.38"	4.38"	4.38"	4.38"	4.38"	4.38"
Dimensions - B	3.72"	3.72"	3.72"	2.74"	2.74"	2.74"
Dimensions - C	3.19"	6.44"	9.67"	3.19"	6.44"	9.67"
Knockouts - Opposite Sides	(1) Concentric 3/4", 1", 1 1/4"	(2) Concentric 3/4", 1", 1 1/4"	(3) Concentric 3/4", 1", 1 1/4"	(2) 1/2", (1) 3/4"	(4) Concentric 1/2", 3/4"	(6) Concentric 1/2", 3/4"
Knockouts - Opposite Ends	(1) Concentric 3/4", 1", 1 1/4"	(1) Concentric 3/4", 1", 1 1/4"	(1) Concentric 3/4", 1", 1 1/4"	(1) 1/2", (1) 3/4"	(2) Concentric 1/2", 3/4"	(2) Concentric 1/2", 3/4"
Knockouts - Bottom	(2) Concentric 3/4", 1", 1 1/4"	(4) Concentric 3/4", 1", 1 1/4"	(6) Concentric 3/4", 1", 1 1/4"	(2) Concentric 3/4", 1", 1 1/4"	(4) Concentric 3/4", 1", 1 1/4"	(6) Concentric 3/4", 1", 1 1/4"

Flush Rectangular Floor Box Covers and Flanges

Covers	S3825 SA3825	S3625 SA3625	S3826 SA3826	S2425 SA2425	S2625 SA2625	S2825 -	S3425 -	S3813 SA3813
Brass								
Aluminum								
	Duplex Flap	Duplex Screw	Style Line Opening	2 1/8" x 3/4" Combination	2 1/8" x 1" Combination	2 1/8" Single Receptacle	2 3/8" Single Receptacle	Blank

Carpet Flanges	1-Gang	2-Gang	3-Gang
Brass	SB3083	SB3084	SB3085
Aluminum	SA3083	SA3084	SA3085
Clear Polycarbonate	S3083	S3084	S3085
			

