

6P6C High Density RJ-11 Voice Module

PRODUCT SPECIFICATION

Package includes:

- A. 6P6C HD RJ-11 Voice Module, 1 pc
- B. Termination Cap, 1 pc
- C. Installation Instructions, 1 sheet

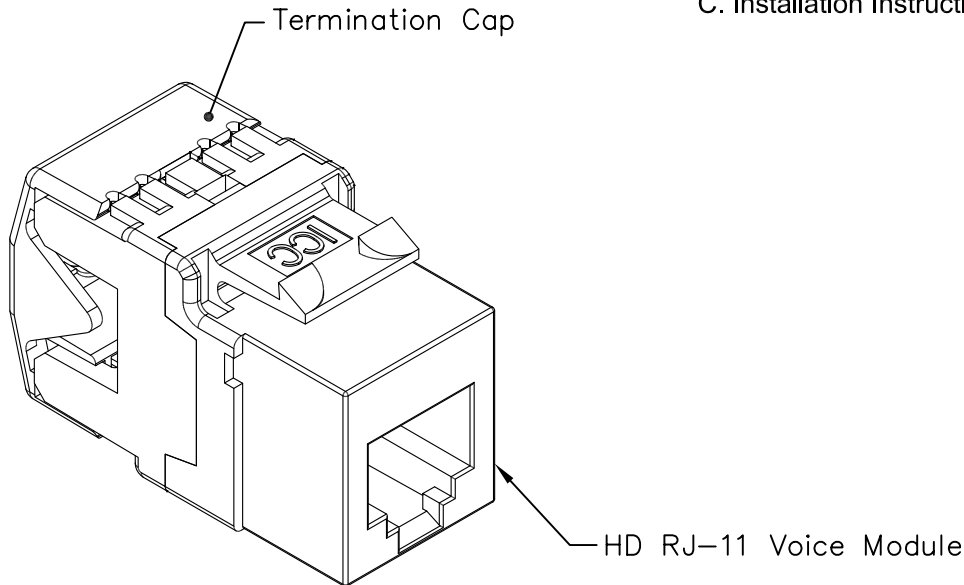

Features and Benefits:

- Designed for all voice connectivity applications
- PCB technology provides maximum performance and superior signal quality
- Engineered to provide 110 IDC termination reducing installation time
- Reduced rear footprint allows for greater connectivity density and provides for more port configurations in a smaller area
- Includes an integrated USOC/UTP color wiring diagram
- Compatible with all IC107 faceplates, inserts, surface mount boxes, and blank patch panels
- Compatible with all IC108 furniture faceplates, bezels, and surface mount boxes
- Used with ICC ICLC2, ICLC4, ICLC6 line cords and 110 punch down tool ICACSPDT00
- Available in almond, black, blue, gray, green, ivory, orange, purple, red, white, and yellow
- Installation instructions #MSR-0378 included
- UL listed

MODULE, VOICE, RJ-11, HD			
ITEM NO.	IC1076FOXX	REV.	B
DWG NO.	PS1076F000	PAGE NO.	1

CUSTOMER CARE / TECHNICAL SUPPORT * CSR@ICC.COM / 888-ASK-4-ICC (275-4422) * 14700 Alondra Blvd., La Mirada, CA 90368* www.icc.com

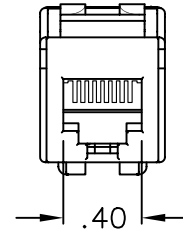
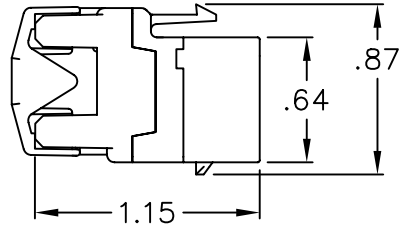
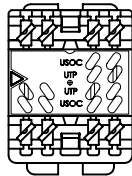
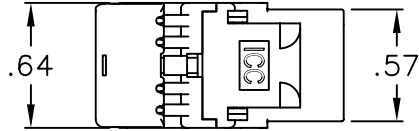

USOC WIRING		UTP WIRING	
1	WHITE	1	WHITE/GREEN
2	BLACK	2	WHITE/ORANGE
3	RED	3	BLUE
4	GREEN	4	WHITE/BLUE
5	YELLOW	5	ORANGE
6	BLUE	6	GREEN

NOTE: UNLESS OTHERWISE SPECIFIED

1. RJ-11 VOICE MODULE:

A. ELECTRICAL:

- CURRENT RATING: 1.5 AMPS MAX
- VOLTAGE RATING: 150 VOLTS ALTERNATING
- DIELECTRIC WITHSTANDING VOLTAGE: 1000 VOLTS RMS, 60 HZ
- INSULATION RESISTANCE: > 10 MOHMS

B. MECHANICAL:

- MATED FORCE: 5 LBS MAX
- UNMATED FORCE: 5 LBS MAX
- PLUG RETENTION FORCE: 20 LBS MIN
- DURABILITY: 750 CYCLES

C. PHYSICALS:

- HOUSING: ABS, UL 94V-0
- CONTACT: PHOSPHOR BRONZE GOLD PLATING OVER 100 INCHES OF NICKEL
- GOLD PLATING: 1.27 MICRON/50 MICRO INCH MIN
- CONNECTOR: INSULATION DISPLACEMENT CONNECTOR (IDC)
ACCEPTS 22~24 AWG SOLID WIRE

D. COLORS: XX: AL-ALMOND, BK-BLACK, BL-BLUE, GN-GREEN, GY-GRAY, IV-IVORY, OR-ORANGE, PR-PURPLE, RD-RED, WH-WHITE, & YL-YELLOW

2. TERMINATION CAP:

- A. MATERIAL: PC, UL 94V-0
- B. COLOR: LIGHT GRAY

NEXT: (NEAR END CROSS TALK)	1 MHz > 65 dB
	10 MHz > 50 dB
	16 MHz > 46 dB
	20 MHz > 44 dB
INSERTION LOSS:	10 MHz > 0.008 dB
	16 MHz > 0.02 dB

UL US FILE NO. 125268

MODULE, VOICE, RJ-11, HD		 PremiumProducts ProvenPerformance CompetitivePrices	
ITEM NO.	IC1076FOXX	REV.	B
DWG NO.	PS1076F000	PAGE NO.	2

CUSTOMER CARE / TECHNICAL SUPPORT * CSR@ICC.COM / 888-ASK-4-ICC (275-4422) * 14700 Alondra Blvd., La Mirada, CA 90368* www.icc.com