

PRODUCT SPECIFICATIONS / INFO



Color: Blue



Configuration:



3100MI6W

UPC Code: 07847712605

Country of Origin: Sweden - **Eligible for ARRA funded projects > \$7,443,000*

Description

100 Amp, 240 Volt, IEC 309-1 & 309-2, 2P, 3W, Mechanical Interlock North American Pin & Sleeve Receptacle, Hub Sold Separately (See Leviton Cat Number HUB-xxx), Industrial Grade, IP67, Watertight, Non-Fused - Blue

Product Features

Color: Blue



**Disclaimer*

AC Horsepower Ratings	
At Rated Voltage	15 HP
Environmental Specifications	
Flammability	No 0.6; V-0 for watertight enclosure
Rain	Type 3R per UL 50
Hosedown	Type 4X per UL 50
Dust	Type 12K per UL 50
Gasket Aging	70C for 168 hours
UV Resistance	Exposed plastic materials are UV stabilized
Operating Temperature	-40C to 60C
Mechanical Specifications	
Mold Stress Relief	70°C for 7 hours
Crush Test	100 lbs
Impact	1.2 lb ball dropped from 5 ft
Cold Impact	Same as above, after conditioning to -35C
Strength of Insulating Base and Support	110% of specified tightening torque on terminal screws
Pullout	18 lb pull on internal wires

Electrical Specifications	
Amperage	100 Amp
Voltage	240 Volt
Pole	2
Wire	3
Current Interrupting	Certified for current interrupting at full rated current
Endurance	6,000 cycles inductive motor type load
Dielectric Voltage	1000 V plus rated voltage for 1-minute





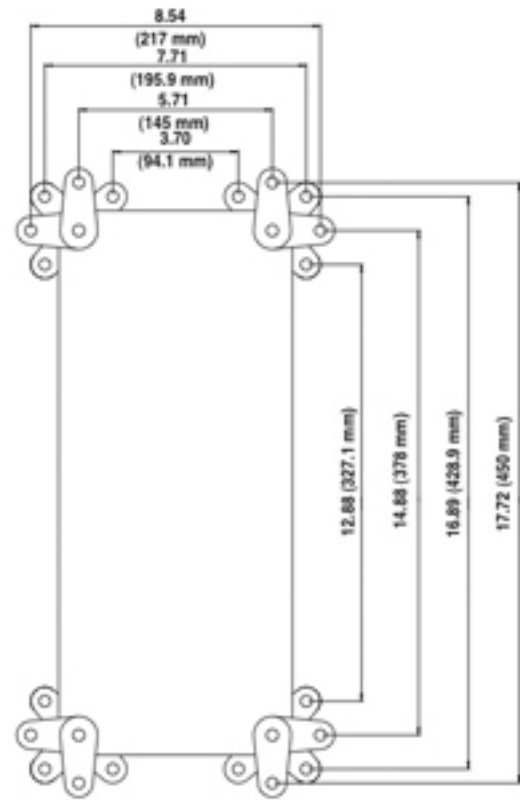
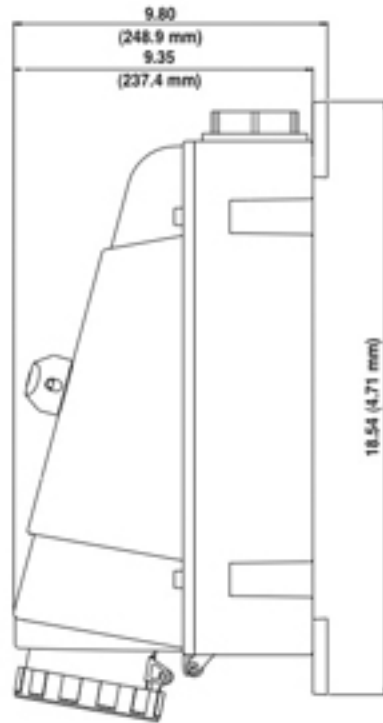
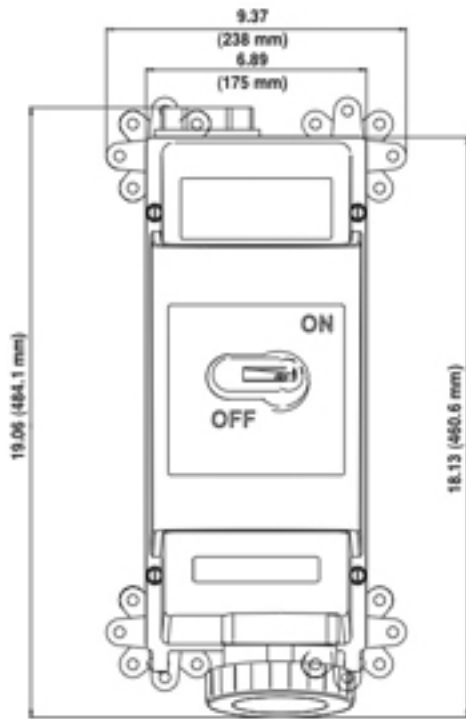

Material Specifications	
Housing Material	Valox 357
Cover with Arm	Valox 357
Locking Ring	Valox 357
Cover Eyelet	Nickel-Plated Brass
Gasket Material	Chloroprene
Handle Material	Valox 357
Actuator Material	Zinc-Coated Steel
Locking Mechanism	Valox 357
Contact Carrier	Nylon
Phase and Ground Sleeves	Brass
Ground Contacts	Brass
Conduit Grounding Plate	Zinc-Coated Steel
Switch Material	Reinforced Nylon
Switch Terminal Contacts	Brass
Switch Contacts	Cadmium-Free Silver Alloy
Internal Screws	Zinc-plated steel
Housing Screws	Stainless Steel
Ground Terminal	Plated Brass/Steel
Ground Terminal Block	Nylon
Neutral Terminal	Plated Brass/Steel
Neutral Terminal Block	Nylon
Terminal Shaft Key	Die-Cast Aluminum

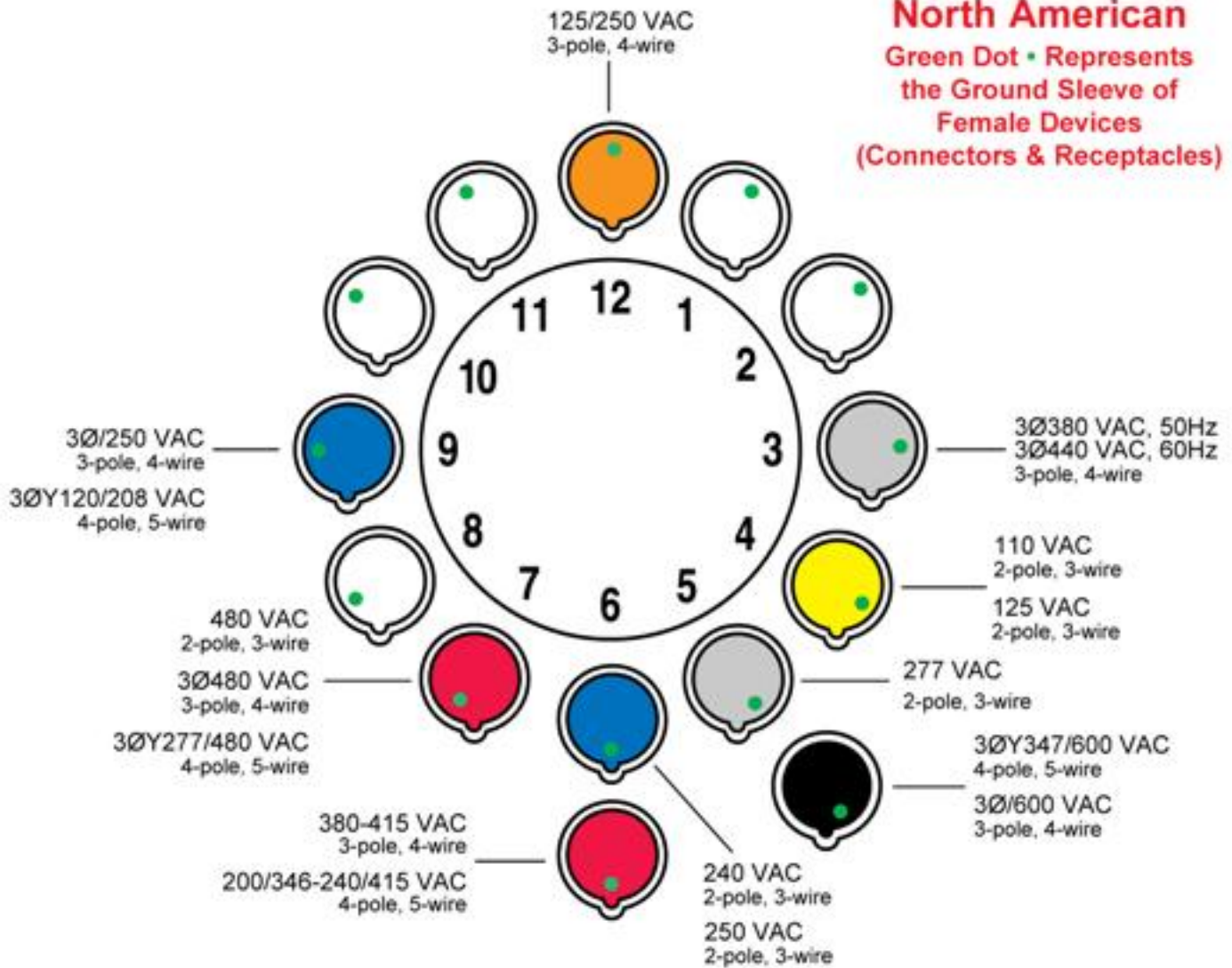
Standards and Certifications	
UL	231 & 1686
UL 508	Non-Fused
CSA	C22.2
CE Marking	Per low voltage directives 73/23/EEC, 93/68/EEC
IEC Rating	60309-1 and 60309-2
Warranty	2-Year Limited



North American
Green Dot • Represents
the Ground Sleeve of
Female Devices
(Connectors & Receptacles)



Rated Voltage	Color
110V-130V	
125V-250V	
200V-250V	
277V, 380V, 440V	
346V-480V	
500V and above	

SPECIFICATION SUBMITTAL

JOB NAME: <input type="text"/>	CATALOG NUMBERS: <input type="text"/>	
JOB NUMBER: <input type="text"/>	<input type="text"/>	<input type="text"/>

Leviton Manufacturing Co., Inc.

201 North Service Road, Melville, NY 11747

Telephone: 1-800-323-8920 · FAX: 1-800-832-9538 · Tech Line (8:30AM-7:30PM E.S.T. Monday-Friday): 1-800-824-3005

Leviton Manufacturing of Canada, Ltd.

165 Hymus Boulevard, Pointe Claire, Quebec H9R 1E9 · Telephone: 1-800-469-7890 ·

FAX: 1-800-824-3005 · www.leviton.com/canada

Leviton S. de R.L. de C.V.

Lago Tana 43, Mexico DF, Mexico CP 11290 · Tel.: (+52)55-5082-1040 · FAX: (+52)5386-1797 ·

www.leviton.com.mx



Visit our Website at: www.leviton.com

© 2007-2010 Leviton Manufacturing Co., Inc. All rights reserved. Subject to change without notice.

Leviton has a global presence.

If you would like to know where your local Leviton office is located please go to:

www.leviton.com/international/contacts/

**Buy American Compliant Logo -- The American Recovery And Reinvestment Act of 2009 ("ARRA") provides federal grants and loans for projects throughout the country. Section 1605 of the Act, named the "Buy American" provision, requires that certain materials and manufactured products used in projects funded by the Act be manufactured in the United States. The appearance of the Recovery Act Logo in relation to a Leviton product is only intended to reflect that such product may be used in an ARRA funded project. It does not mean that such product or Leviton is sponsored or endorsed by, or that Leviton receives funds from, the federal government or the Recovery Accountability and Transparency Board. Nothing in Leviton's use of the logo is intended to suggest anything regarding the requirements for funding under ARRA.*