

KB Series  
**AUDIO-ONLY SUB-MASTER STATION**

Model: **KB-3SD**

**INSTALLATION & OPERATION MANUAL**

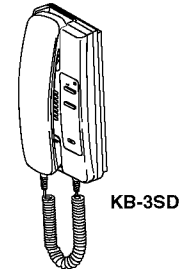







**⚠ PRECAUTIONS ON OPERATIONS**



This Manual and the Markings on the product contain various symbols in order that the product can be used safely and properly, and that the installer and user are protected from injury and property damage. The following precautions must be thoroughly read and understood before proceeding.

**⚠ WARNING** *Negligence could result in death or serious injury.*

**⚠ CAUTION** *Negligence could result in injury or damage to property.*

**⚠ WARNING**

1. Do not change or alter KB-3SD. It can cause fire or electric shock. 
2. Keep KB-3SD away from water or any other liquid. Fire or electric shock could result. 
3. Keep AC cord of power supply from being marred or crushed. If damaged, fire or electric shock could result. 
4. Do not plug or unplug with wet hands. Electric shock could result. 
5. Keep AC plug away from moisture or dust. Fire could result. 
6. Do not use any power source other than specified. Fire or electric shock could result. 

4. Do not install KB-3SD in any of the following locations, as it can cause fire, electric shock or unit damage: 
  - High or extreme cold temperature area, under direct sunlight, near equipment that varies in temperature, in front of air conditioner, inside a refrigerated area, etc.
  - Places subject to moisture or humidity extremes (bathroom, cellar, greenhouse, etc.) 
  - Places subject to environmental conditions, such as oil, dust, chemicals, salt, etc.
  - Places subject to constant vibration or impact.
  - Where noise generating devices such as TV or radio are close by.
  - Places subject to steam or smoke (near heating equipment or cooking surfaces)
5. Do not install or make wire terminations while power supply is plugged in. It can cause electrical shock or damage to the unit.

**⚠ CAUTION**

1. Mount KB-3SD on wall in a convenient location, but not where it could be bumped or jarred.
2. Verify chime volume while handset is on the hook. Chime sounds from KB-3SD speaker very loudly and can cause hearing damage.
3. Before plugging in power supply, make sure wires are not crossed or shorted. Fire or electric shock could result. 

**⚠ GENERAL PRECAUTIONS**

1. KB-3MRD system is not operational during a power failure.
2. Keep all DC wiring at least 30cm, 1' away from AC 100-240V wiring, fluorescent lighting, or dimmer switches. Otherwise, cross AC wiring at a 90° angle.
3. KB-3MRD system has to be kept in the distance of more than 1m, 3'3" away from TV or radio.

*Explanations of Symbols;*

**⚠ GENERAL PRECAUTIONS**  
The  mark indicates caution statement (incl. danger and warning), which is specifically shown inside.

**ⓘ GENERAL INSTRUCTIONS**  
The  mark indicates contents which demands a specific action shown inside or attached.

**⊘ GENERAL PROHIBITIONS**  
The  mark indicates contents which prohibit a specific action shown inside or attached.

**⊘ DISMANTLE PROHIBITIONS**  
**⊘ MOISTURE PROHIBITIONS**



# 1 SYSTEM OUTLINE & COMPONENTS

The KB-3SD is an audio-only sub master station for use in KB-3MRD system. One or two KB-3SD's can be used in place of KB-3HRD sub master station with monitor.

## PACKAGE CONTENTS

- Audio only sub master station (KB-3SD)
- Packet of screws
- Installation & Operation Manual

## SYSTEM LAYOUT

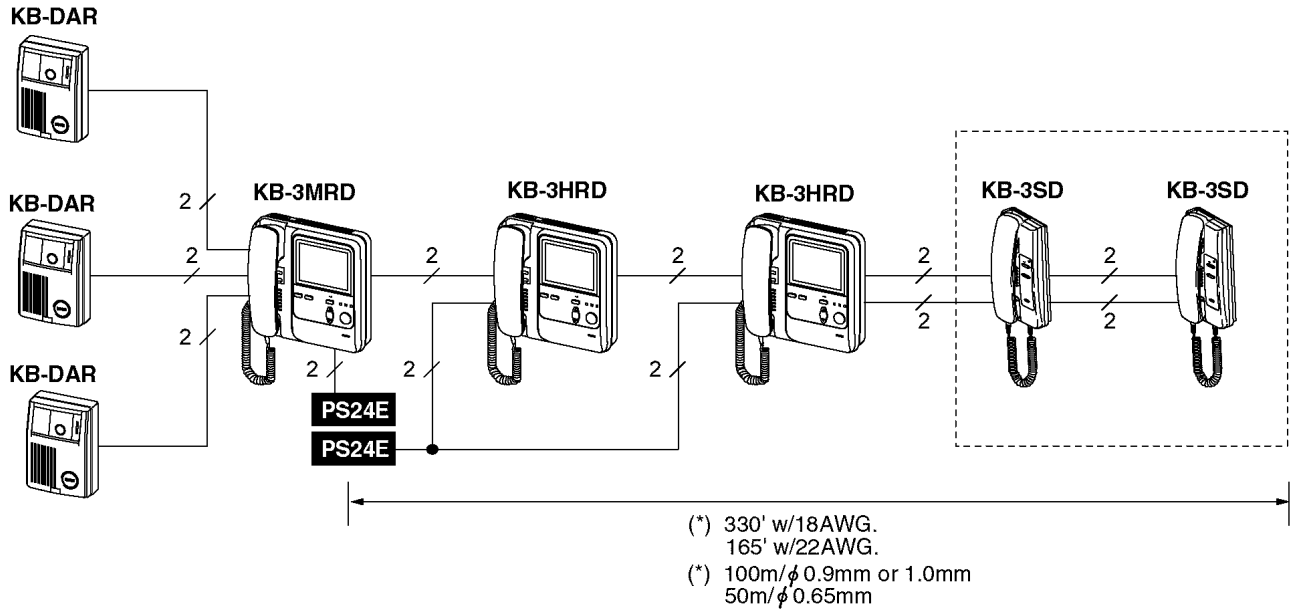

## COMPONENTS AVAILABLE

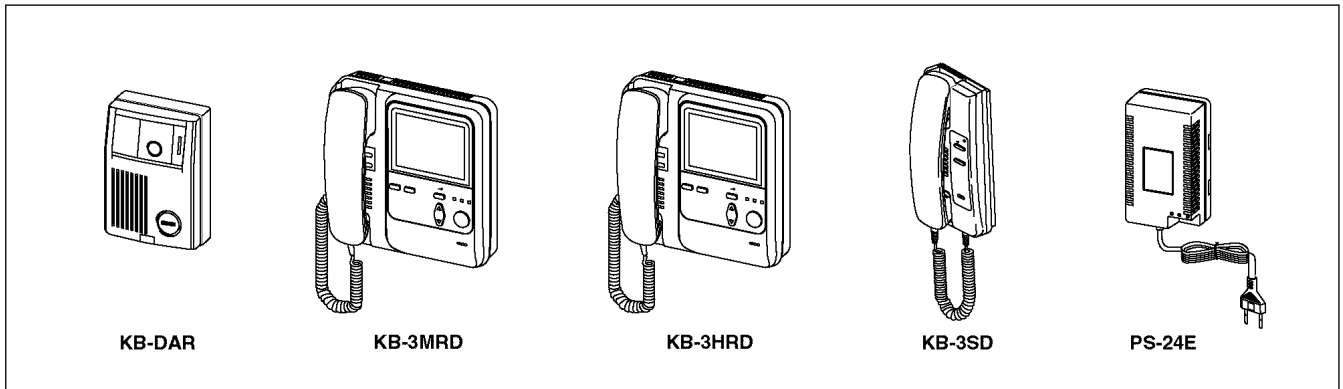

- KB-DAR:** Video door station.  
**KB-3MRD:** Master station.  
**KB-3HRD:** Sub station (2 ~ 4 pcs).  
**KB-3SD:** Audio sub master station (max. 2 pcs).  
**PS-24E:** 24V DC power supply (2A).



## 2 NAMES & FEATURES

---

### KB-3SD

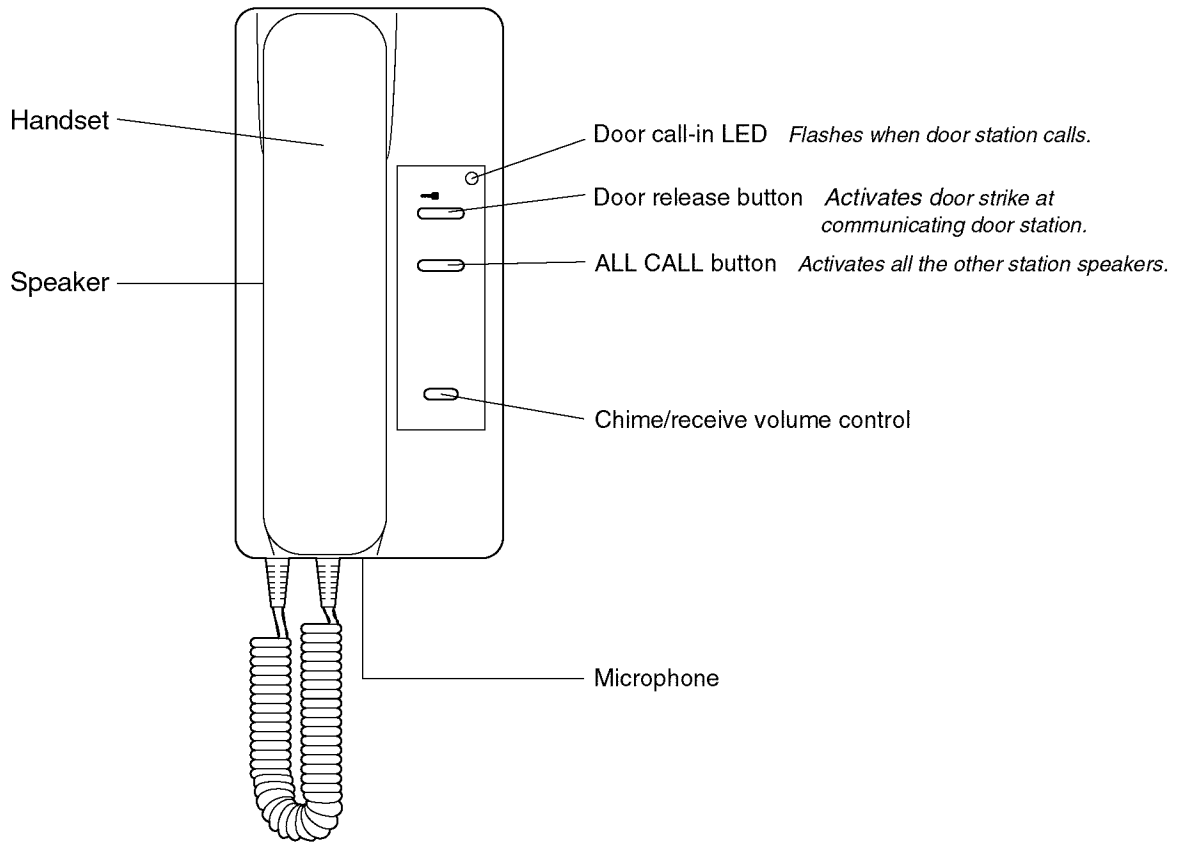

### FEATURES

1. Audio only sub station, capable of answering door, activating door strike, used in place of KB-3HRD.
2. ALL CALL button to call the other stations with pre-tone and voice.
3. Handsfree, simultaneous reply for internal call.
4. Privacy setting.
5. Volume control for chime & receive.
6. Door Release & ALL CALL buttons light when the function is operated.
7. Single-gang wall mounting (bracket supplied).



### 3 MOUNTING

1. Separate the mounting bracket from the unit.  
Attach the mounting bracket to single-gang box with supplied screws.
2. Connect wires to terminals of KB-1SD.  
Set for room # jumpers and impedance matching switch.
3. Align the mounting bracket with the unit, insert the prongs of the bracket into the chassis, pull the unit downward until it locks into place.

#### • Single-gang surface mounting

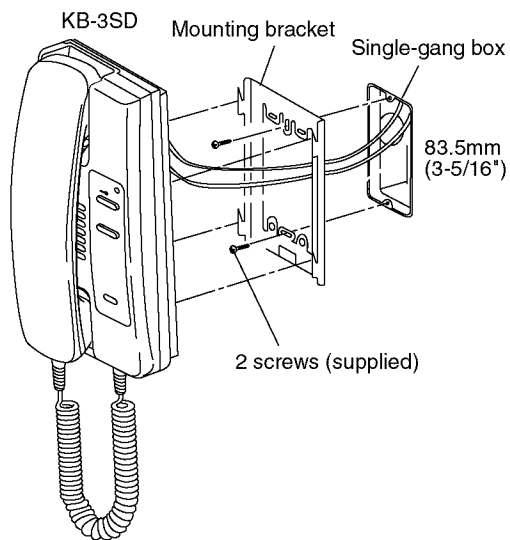

#### • Surface wall mounting

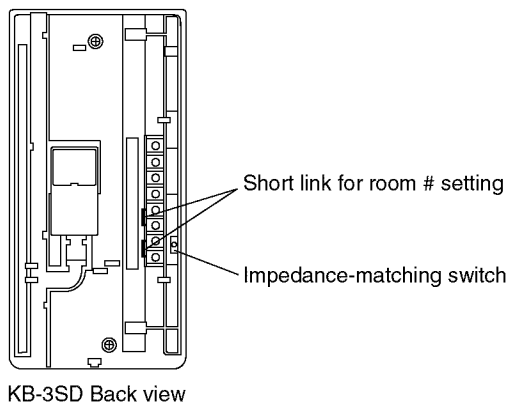
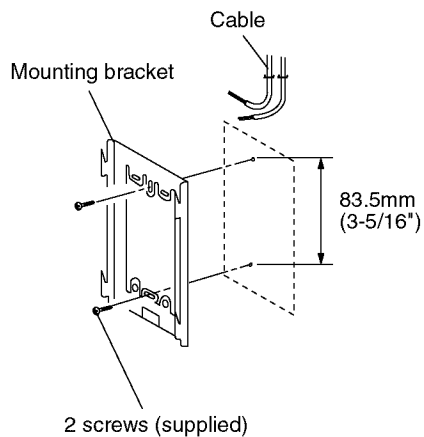

# 4 WIRING

## ⚠ Wiring Precautions

1. Use cable with a polyethylene (PE) insulation. Coax-cable can not be used.
2. When using an existing cable other than 2-conductor parallel cable, terminate any unused pairs with a 120Ω resistor.

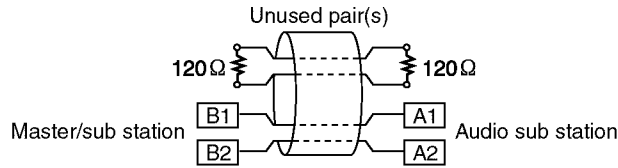

3. When system does not operate properly with existing cable, replace wires. Sub station with monitor or audio only CAN NOT be homerun wired.

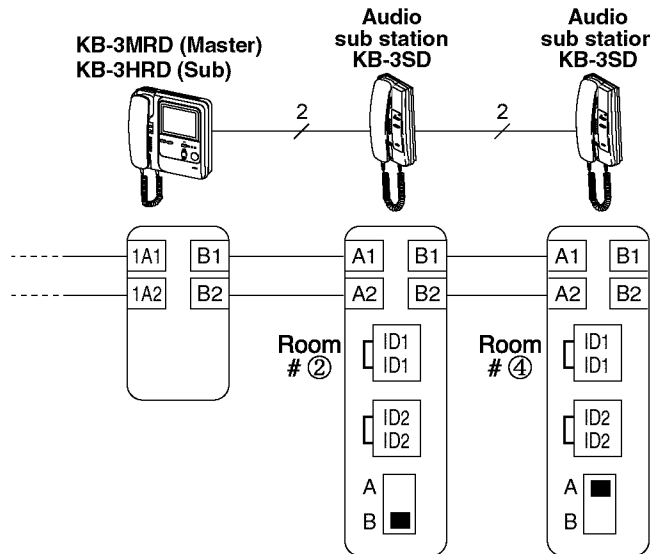
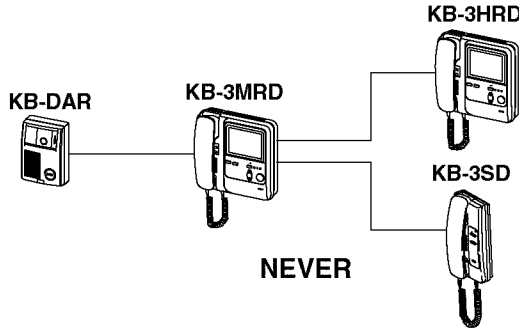

### • Room # setting

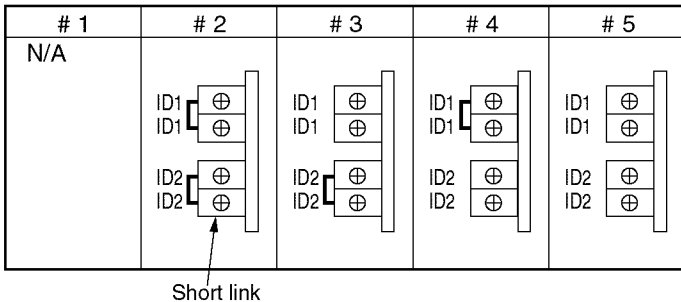

### • Video impedance matching

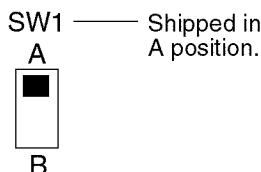

When system has more than 2 sub-master stations, put all the SW1 to B position except on last sub station.

⚠ Do not use any vacant terminal for any other purpose.

# 5 OPERATIONS

## Receiving

### • Door call

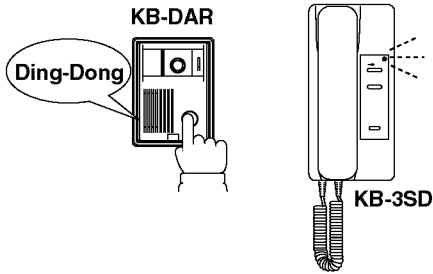

1. Momentarily depress CALL button.
2. Chime tone sounds, and call-in LED flashes.

| DOOR STATION | CHIME  | LIGHT      |
|--------------|--------|------------|
| Door 1       | 4-tone | red LED    |
| Door 2       | 2-tone | green LED  |
| Door 3       | 8-tone | orange LED |

Note: Call-in times out approx. 30 sec. after call in.

3. Lift handset, communicate.
4. When finished, hang up handset.

### • Room call (by all call)

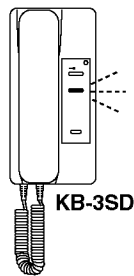

1. Pre-tone sounds, and ALL CALL button flashes.
2. Lift handset, communicate. ALL CALL button is steadily lit.
3. When finished, hang up handset.
4. ALL CALL light goes off.

### • Room call (by selective call)

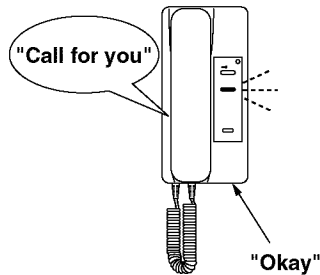

1. Pre-tone sounds, and ALL CALL button flashes.
2. Voice is heard from speaker. Reply hands free or lift handset for private communication.
3. When the calling station replaces its handset, the channel is shut off. (no further operation is necessary)  
Hang up the handset. (If using handset for privacy)

### • Privacy (Open voice mic. is muted on your station)

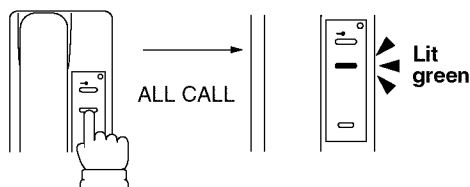

Press for 2 sec.  
or more.

When your station is set for privacy, pick up handset to reply to any call.

#### Setting for privacy

1. With handset on the hook, depress ALL CALL button more than 2 sec.
2. Privacy mode is set. Green light is on inside ALL CALL button.
3. To release the privacy mode, depress ALL CALL button more than 2 sec., with handset on the hook. The green light turns off.



### • Placing internal call (⚠ Selective call is not available.)

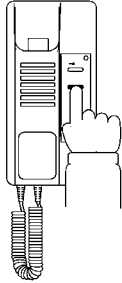

1. Lift handset, momentarily depress ALL CALL button.  
(ALL CALL light flashes red)
2. Call verbally to all other stations.  
(ALL CALL light is steadily lit.)
3. When finished, hang up handset.
4. ALL CALL light goes off.

#### Note:

- ① When a red light is steadily lit in ALL CALL button or door call-in LED is lit, the system is in use.  
Wait until the light goes off.

### • Receiving a door call during internal call

1. Chime tone is heard from handset.  
Door call-in LED flashes.
2. Hang up both handsets to end internal call.
3. Pick up handset at an answering station.  
Door call-in LED is lit.
4. When finished, hang up handset.
5. LED goes off.

### • Transferring a door call

1. While communicating with door station, momentarily depress ALL CALL button.  
Call verbally to the rest of the stations.
2. When the call is acknowledged by the transferred station, hang up the handset.

### • Receiving a transferred door call

1. When called, pick up handset.
2. Hang up at both stations, and pick up at the transferred station.
3. When finished, hang up handset.

### • Activating door strike

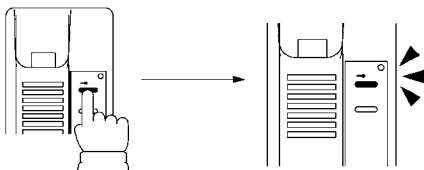

1. While communicating with a door station depress and hold down Door Release button.  
The light is steadily lit.
2. Door strike activates at the communicating door.  
Hang up handset. (The light remains lit, while door strike is active.)

## 5 OPERATIONS (continued)

### Adjust chime tone/receive volumes

#### • Chime tone

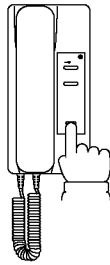

With handset on the hook, press Vol. switch.  
Each press changes the volume:  
STANDARD → HIGH → CUT OFF.

#### • Receive volume

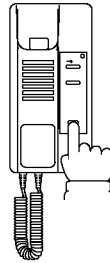

While communicating with door station or other room station,  
press Vol. switch.  
Each press changes the volume:  
STANDARD → HIGH → EXTRA HIGH.

**Notes:** Volume adjustments are made at individual station.  
After power failure, etc., the volume is reset to initial STANDARD position.

## 6 TECHNICAL PRECAUTIONS

### Precautions on Operations

- KB-3SD may collect dust. Clean unit as needed.
- Replace KB-3SD handset on cradle securely. If called when handset is off-hook, inside audio can be heard at the door for approx. 2-1/2 minutes.

### Cleaning

Clean the KB-3SD unit with a soft cloth dampened with neutral household cleanser. Never use any abrasive cleaner or cloth.

## 7 SPECIFICATIONS

### KB-3SD

- Power source: 22V DC (approx.), supplied by master station.
- Current consumption: Max. 85mA. (approx.)  
50mA (approx. in Standby).
- Communication: Simultaneous with handset.  
Handsfree simultaneous at called station (In internal call).
- Ambient temperature: 0°C ~ 40°C (14°F ~ +104°F)
- Housing: Fire retardant ABS plastic.
- Dimensions: 100 W x 210 H x 73.5 D (mm).
- Weight: Approx. 460g (1.01 lbs.).



### WARRANTY

- \* Aiphone warrants its products to be free from defects of material and workmanship under normal use and service for a period of two years after delivery to the ultimate user and will repair free of charge or replace at no charge, should it become defective upon which examination shall disclose to be defective and under warranty. Aiphone reserves unto itself the sole right to make the final decision whether there is a defect in materials and/or workmanship; and whether or not the product is within the warranty.
- \* This warranty shall not apply to any Aiphone product which has been subject to misuse, neglect, accident, or to use in violation of instructions furnished, nor extended to units which have been repaired or altered outside of the factory. This warranty does not cover batteries or damage caused by batteries used in connection with the unit.
- \* This warranty covers bench repairs only, and any repairs must be made at the shop or place designated in writing by Aiphone.
- \* Aiphone will not be responsible for any costs incurred involving on site service calls.

AIPHONE CO., LTD., NAGOYA, JAPAN  
AIPHONE CORPORATION, BELLEVUE, WA, USA  
AIPHONE EUROPE N.V., ANTWERP, BELGIUM

KB-3SD-L(E) 0100A

COMMUNICATION SYSTEMS  
 **AIPHONE**<sup>®</sup>  
HOME, BUSINESS, INDUSTRY.

Printed in Japan (E)