

45 Degree Splice Kit

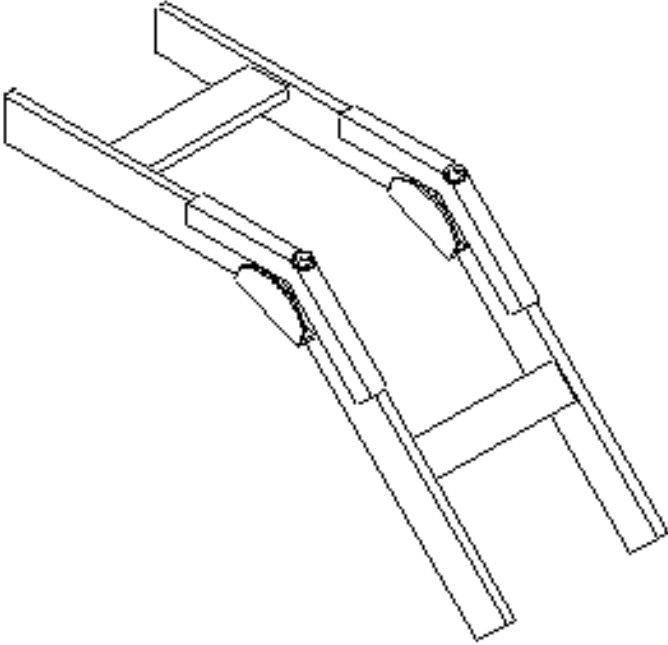

Features

- Used to make a butt splice at a 45 degree angle on any 1-1/2" x 3/8" type cable runway
- Usable on tubular and solid type cable runway

Specifications

- Formed steel construction
- Gold zinc plated
- Each kit contains:
 - (2) 45 degree outside clamps
 - (2) inside clamps
 - (2) 3/8"-16 x 2" bolts
 - (2) 3/8"-16 hex nuts
 - (2) 3/8" split washers

Copyright © 2004 Southwest Data Products

