

SSW-321-D TELEPHONE

Stainless Steel, Vandal Resistant, Rugged Telephones Built to Last

The CEECO SSW-321-D model is a vandal resistant, stainless steel, autodial telephone designed to automatically dial a pre-programmed number from one (1) to eleven (11) digits when the handset is lifted. Our rugged, industrial grade telephone is ideal for areas where a hotline or a single speed dial phone is needed. Also ideal for locations where call control is done by the user being automatically connected to an operator, who would then dial the allowed number, limiting the users' dialing access. Constructed with marine quality chrome hookswitch, armored cord handset with internal steel lanyard, and installed with tamper resistant security screws providing durability that you can rely on. *(Security tool is required for installation).*



SPECIFICATIONS

INPUT POWER:	C.O. Line Powered or PBX
LOOP CURRENT:	23mA min to 80mA max *will work down to 15mA in most applications
IMPEDANCE:	600 ohms
SIGNALING:	DTMF
HEARING AID COMPATIBLE:	Meets EIA standards
ENVIRONMENTAL:	Temperature: -30°C (-22°F) to 60°C (140°F) Humidity 0%-90% non-condensating
RINGER EQUIVALENCY:	0.4A
TYPE JACK:	RJ11C
TELEPHONE COVER:	Brushed 16 ga. Stainless Steel
DIMENSIONS:	5" Wide x 10 3/4" High x 5.5" Deep (handset on-hook)
MOUNTING:	Vertical surface mount
WEIGHT:	7 lbs.
FCC REGISTRATION:	BW-88T7-13717-TE-T
UL LISTED NO.:	6OF5

ACCESSORIES:

301-037	Security Tool (required for installation)
---------	--



FEATURES

Measurements: 5"W x 10 3/4"H x 5 1/2"D

Stainless Steel Construction with Tamper Resistant Hardware

Marine Quality Chrome Tone Dial, Swivel, and Hookswitch

Line Powered

Hearing Aide Compatible Armored Cord Handset with Steel Lanyard

Mounting Backplate Included

Equipped with an ADT-11 automatic tone dialer that dials from 1 to 11 digits

Customization Available. Call to discuss requirements

Requires 301-037 Security Tool for Installation

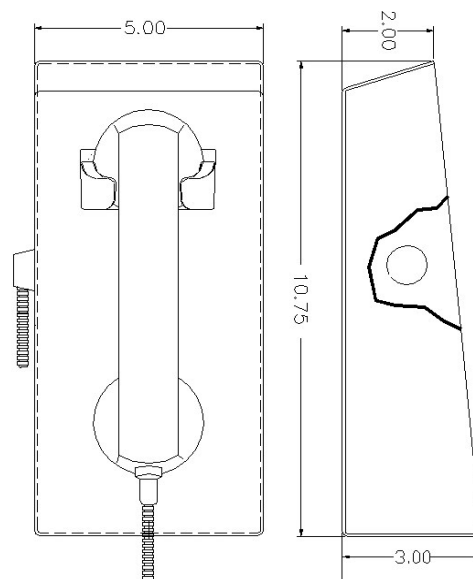

Providing Telecommunication Solutions Since 1930

Communication Equipment
& Engineering Company











Web: www.ceeco.net
Email: sales@ceeco.net

519 SW Park Street
Okeechobee, FL 34972
Voice 863-357-0798
Fax 863-357-0006

SSW-321-D TELEPHONE

PRODUCT MANUALS WITH FULL FEATURES AND FUNCTIONS AVAILABLE UPON REQUEST

				
SSW-321-D	SSW-321-D-M-IVC	SSW-321-D-M-ACH12	SSW-321-D-RIL	SSW-321-D-M-IVC-RIS
Our standard vandal resistant, mini stainless steel wall autodial telephone model includes a 32" armored cord handset with steel lanyard, and backplate and is specifically designed for all areas subject to vandalism and frequent abuse.	The SSW-321-D-M-IVC model is equipped with the sealed magnetic hookswitch (M) & internal volume control with background noise reduction button on the face of the housing (IVC). This is commonly used in busy or noisy areas such as airport terminals, and busy waiting rooms.	The SSW-321-D-M-ACH12 model with the magnetic hookswitch (M) and 12" armored cord handset (ACH12) is commonly used in psychiatric and correctional facilities where the need for minimal moveable parts and shorter cords are necessary to reduce abuse to the unit and the user.	The SSW-321-D-RIL model with a Ring Indicator Light (RIL) is commonly used in noisy and busy areas where it is necessary to visually see the phone ringing such as dormitory hallways, distribution, and manufacturing facilities.	The SSW-321-D-M-IVC-RIS model with the magnetic hookswitch (M), internal volume control (IVC) and Ring Indicator Strobe Light (RIS) is commonly used where location recognition of phone activation is imperative, such as gas stations, airports, and other critical areas.
Dimensions: 5"W x 10 3/4"H x 5 1/2"D Weight: 7lbs Product Link: Click here	Dimensions: 5"W x 10 3/4"H x 5 1/2"D Weight: 7lbs Product Link: Click here	Dimensions: 5"W x 10 3/4"H x 5 1/2"D Weight: 7lbs Product Link: Click here	Dimensions: 5"W x 10 3/4"H x 5 1/2"D Weight: 7lbs Product Link: Click here	Dimensions: 5"W x 12"H x 5 1/2"D Weight: 8lbs Product Link: Click here

ADDITIONAL OPTIONS									
-M	-IVC	-ACH**	-ACH*	-CCH*	-PBVC	-C	-ADA	-RIL	-RIS
									
Sealed Magnetic Hookswitch that uses standard handset.	ADA compliant push button volume control and background noise reducer. (Built into phone)	Other Length armored cord from 12" to 72"(inches). Example: -ACH12 12" Long	ACHW -White Handset ACHR -Red Handset (Black is standard)	Coiled cord available from 5', 10', & 15' (feet). Example: -CCH5 5' Long	Pushbutton volume control handset	Background noise reduction in handset	Braille EMER emergency Plate	Ring Indicator Light	Ring Indicator Flashing Blue Light (Requires AC Power)

IP - Voice over Internet Protocol Version available on all models (SIP)

CUSTOMIZATION - Call us for MORE available options and features

Visit our website at www.ceeco.net or call us at 863-357-0798 for detail specifications on any of our models.

CEECO has been providing telecom solutions since 1930. Our vandal resistant technology focuses on providing public communication solutions while reducing replacement and repair costs, lowering the customer's total cost of ownership. CEECO also offers custom design and branding to your specifications. Our commitment to providing expert service and support extends beyond the warranty of our product. We offer support for the life of the product! CEECO is devoted to giving you the quality and service you deserve.



Providing Telecommunication Solutions Since 1930

Communication Equipment & Engineering Company

Web: www.ceeco.net

Email: sales@ceeco.net

519 SW Park Street
Okeechobee, FL 34972

Voice 863-357-0798

Fax 863-357-0006