

Audio/Video Distribution

Decora Media™ System

Distribute Audio and Video signals anywhere in the home using Category 5 Cable and Leviton's Decora Media System (DMS). Send VCR, DVD, cable TV, satellite and security camera signals through up to 1,000 feet (300 meters) of cable with no discernible audio or video distortion and better performance than the more expensive, specialized "designer" cables.

DMS is comprised of: a Send Unit for transmitting audio/video signals, a Receive Unit for receiving signals, and a Media Hub for whole house distribution.

The DMS utilizes advanced active electronics to operate with several different topologies: a star wiring scheme, with peripheral components sending and receiving critical information via Send and Receive units and the centralized data-communications hub; a Hub-to-Receive model, where information is sent to the hub-and from the hub to remote Receive units; and a Point-to-Point model, where Send and Receive units are linked directly together.

Send and receive units run on 12VDC, hub runs on 15VDC and can be powered independently or through the Media Hub.

For Category 5 patch cords, see page 33.

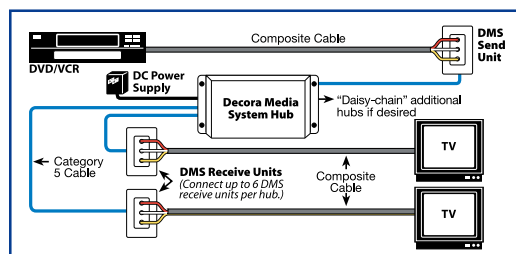
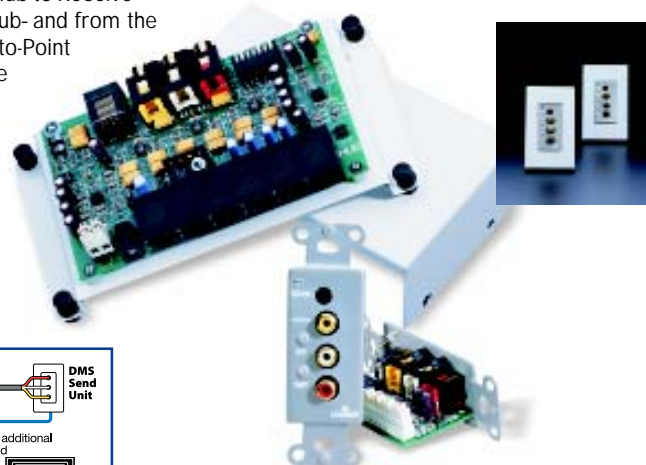

FEATURES

- Panel can be attached vertically or horizontally in SMC Enclosures.
- Cascade hub units to distribute audio/video signals to over 20 locations.
- Send and Receive units are equipped with RJ-45 jacks and 110 punchdown blocks for maximum flexibility in installation.
- Composite RCA inputs for connectivity directly from A/V source.
- Send and Receive units fit standard wallboxes and Decora wallplates.
- Advanced circuitry with automatic equalization streams analog audio and video signals over long distances with less distortion.
- Stereo audio input/output handles Dolby® ProLogic™ surround signals.
- Send VCR, DVD, cable TV, satellite and security camera signals through Category 5 cable.
- RJ-45 input for Send unit.

Decora Media System

Specifications	Send Unit	Receive Unit	Media Hub
Dimensions:	4.1"h x 1.4"w x 2.0"d	4.1"h x 1.4"w x 2.0"d	6.5"h x 3.4"w x 1.75"d
Video Bandwidth:	50 M Hz @ -3 dB	50 M Hz @ -3 dB	50 M Hz @ -3 dB
Video THD:	75 dBc	-75 dBc	-75 dBc
Video Input:	-	0.5V to 2V composite	0.5V to 2V composite
Video Output:	0.5V to 2V composite	-	-
Slew Rate:	800/Vus	800/Vus	800/Vus
Audio Input Impedance:	-	20k Ohms, max 3Vp-p	20k Ohms, max 3Vp-p
Audio Output Impedance:	51 Ohms, max 2Vp-p	-	-
Audio Freq. Response:	5 Hz-100k Hz, ±3 dB	5 Hz-100k Hz, ±3 dB	5 Hz-100k Hz, ±3 dB
Audio THD:	0.002% 20 Hz-20k Hz	0.004% 20 Hz-20k Hz	0.002% 20 Hz-20k Hz
Audio S/N Ratio:	100 dB typical, 80 dB min 20 Hz-20k Hz	100 dB typical, 80 dB min 20 Hz-20k Hz	100 dB typical, 80 dB min 20 Hz-20k Hz
Input Noise:	4.5nV/(Hz), 1/2 typical @ 1k Hz	6nV/(Hz), 1/2 typical @ 1k Hz	4.5nV/(Hz), 1/2 typical @ 1k Hz
Input and Outputs	3 RCA input jacks 1 set RJ-45 in/out jacks 1 110 punchdown out 1 DC power input	3 RCA output jacks 1 set RJ-45 in/out jacks 1 110 punchdown out 1 DC power input	3 RCA input jacks 1 RJ-45 input jack 6 RJ-45 output jacks 1 DC power input
Power:	12VDC	12VDC	15VDC

Decora Media System

Description	Part Number
Decora Media System Media Hub with Power Supply	48210-MCH
Decora Media System Send and Receive Unit Pair with Power Supply	48210-SRU
Decora Media System Send Unit with Power Supply	48210-MSU
Decora Media System Receive Unit	48210-MRU



Audio/Video Distribution

1x6 Passive Audio Module

Easy, centralized audio system distribution module that connects up to six pairs of speakers from an entertainment center or amplifier. Just run speaker wire to this passive bridging module and fill multiple rooms with high-quality music or sound. Supports up to six pairs of speakers; ideal for multi-room sound systems. Note: To ensure a correct impedance match with an amplifier, only use the passive audio module with impedance matched volume controls or a system matching device.



FEATURES

- Supports up to six pairs of speakers.
- Combine with Decora Volume Controls to control up to six pairs of speakers from one amplifier or receiver.
- Parallel connection scheme insures the best sound quality.
- User-removable connectors facilitate installation.
- Connects with standard speaker wire.



1x6 Passive Audio Module	
Specifications	
Dimensions:	6.58h x 2.89w x 1.42d
Wire Gauge	18-14 AWG
Requirements:	Product should be used with impedance-matched volume controls or controller.
1x6 Passive Audio Module	
Description	Part Number
1x6 Passive Audio Module	48211-6A

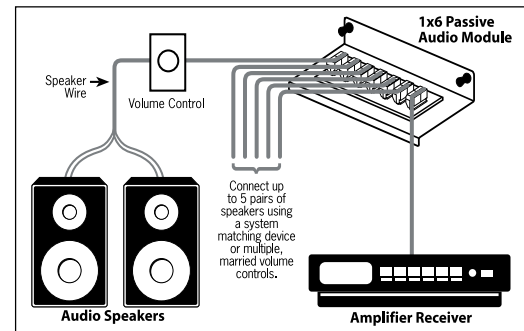

Composer Series Audio and Speaker Controls

Leviton's Composer Series controls are built to a single quality standard, which means system designers can specify them for any distributed sound application with total confidence. (Leviton's Chopin Digital Volume control uses the same heat-dissipation technology used on the space shuttle and resistive switching to achieve ruler-flat frequency response.) On the rotary analog controls, tapped auto-transformer design provides a stable interface between high-current amplification and speakers of virtually any type while resisting contamination from dust and dirt.

All analog audio power ratings are UL referenced. All volume controls feature screw connectors for long-term connection integrity.

FEATURES

- Connects to Interface Module with a single RJ-45 connection. No direct speaker/ amplifier connections required at the controller.
- Microprocessor-controlled relays for silent switching.
- Provides impedance matching with speakers from 4-16 Ohms.
- Terminate all amplifier and speaker connections using high-quality audio connection block.
- Digital, transformer-free design uses aerospace-quality cermet resistors for proper heat dissipation and superior performance.
- Each audio zone requires one Digital Volume Control module.
- Each Digital Volume Control module can support up to three volume control units.
- Each Digital Volume Control module can control up to 4 pairs of speakers.
- Tap mute feature activated when pressing center of rocker panel.

Decora Digital™ Chopin™ Volume Control

Fill a home with high-quality audio at the touch of a button, replacing traditional transformers and rotary controls with this advanced interface module and one-touch Decora Chopin™ rocker-switch wall unit. Attractive Decora styling and transformer-less design bring simplicity and superior sound-quality to this advanced audio delivery system. The Volume Control mounts in a standard wall box or low-voltage mounting bracket and connects via Category 5 cable to the Interface Module in the SMC. Decora Chopin Wall units are a perfect match with Decora Mural™ lighting controls, fit in all Decora wallplates, and accommodates up to 4 pairs of speakers if wired in a series/parallel configuration.

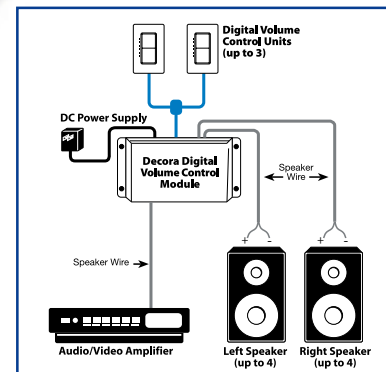

Decora Digital Volume Control System	
Specifications	
Peak RMS Power Rating:	200 Watts per channel
Continuous Power Rating:	100 Watts RMS per channel
Frequency Response, all rated power levels, +/-0.1 dB:	DC-50,000 Hz
Speaker Impedance:	4-16 Ohms nominal
Speaker/Amplifier Connection:	Removable, snap-in audio monoblock w/screw terminals
Power Requirements:	12 Volts DC, 200 mA

Decora Digital Volume Control System	
Description	Part Number
Decora Digital Volume Control Kit (Includes Interface Module and Wall Unit with Power Supply)	48211-*VK
Decora Digital Volume Control Wall Unit	48211-*VC

*Colors: (I) Ivory, (W) White, (A) Almond



Composer Series Analog Audio Controls

Brahms™ Stereo Volume Controls - 75 Watt Audio

The 75 Watt Brahms series (25 Watts RMS) of volume controls is ideal for low to moderate power installations in the home and for use with dedicated multi-room amplifiers and mini-systems. The units accommodate 4, 8 or 16 Ohm speakers and amplifiers up to 75 Watts. All controls facilitate impedance matching.

Attenuation: -34 dB in 12 steps. Attenuator Type: Tapped auto transformer. Power Rating: UL Listed @ 75 Watts audio, 25 Watts RMS continuous. Frequency Response: 35 Hz - 20 kHz. Screw type connections, 12 position rotary switch.

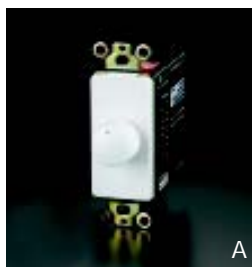

A

Decora® Brahms Stereo Volume Control

Control stereo volume from convenient wall-mounted location.

Decora® Brahms Stereo Volume Control		
Description	Ivory	White
(A) Decora® Brahms Stereo Volume Control, 75 Watt, 25 Watt RMS with insert, knob and plate		
Boxed unit pack, rack pack carton	40841-DI	40841-DW



B

Brahms Dual Stereo Volume Controls

Control two stereo systems at one location.

Brahms Dual Stereo Volume Controls		
Description	Ivory	White
(B) Brahms Dual Stereo Volume Controls, 75 Watt, 25 Watt RMS on two gang plate		
Boxed unit pack, rack pack carton	40899-I	40899-W



C

Decora® Brahms Stereo Volume Control With A/B Switch

Provide audio source selection and volume control from a single location.

Decora® Brahms Stereo Volume Control With A/B Switch		
Description	Ivory	White
(C) Decora® Brahms Stereo Volume Control, 75 Watt, 25 Watt RMS with two gang plate		
Boxed unit pack, rack pack carton	40902-DI	40902-DW

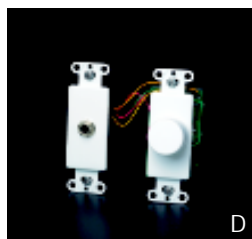

D

Decora® Brahms Stereo Volume Control With 1/4" Phonoplug Headphone Jack

Control volume and enable the use of headphones for private listening.

Decora® Brahms Stereo Volume Control With 1/4" Phonoplug Headphone Jack		
Description	Ivory	White
(D) Decora® Brahms Stereo Volume Control, 75 Watt, 25 Watt RMS with two gang plate		
Boxed unit pack, rack pack carton	40903-25I	40903-25W



E

Decora® Brahms Stereo Volume Control With On-Off Switch

Convenience of on/off, as well as volume control.

Decora® Brahms Stereo Volume Control With On-Off Switch		
Description	Ivory	White
(E) Decora® Brahms Stereo Volume Control, 75 Watt, 25 Watt RMS with insert, knob and plate		
Boxed unit pack, rack pack carton	40905-25I	40905-25W



F

Outdoor Stereo Volume Control

Enables the control of stereo volume from an outside location. Weatherproof with gasket.

Outdoor Stereo Volume Control	
Description	Gray
(F) Outdoor Stereo Volume Control, 75 Watt, 25 Watt RMS with weather resistant enclosure	
Boxed unit pack, rack pack carton	40853-OVC

 **Enhanced**

Composer Series Analog Audio Controls

Strauss™ Stereo Volume Controls - 216 Watt Audio

The 216 Watt Audio (72 Watt RMS) Strauss volume control series is ideal for higher power installations in the home, and for use with home theater receivers and separate power amplifiers. Their heavy-duty autoformer construction is designed to resist saturation and degradation even after years of high-volume use while maintaining signal purity. The units accommodate 4, 8 or 16 Ohm speakers and amplifier systems rated up to 216 Watts. All controls facilitate impedance matching.

Attenuation: -34 dB in 12 steps. Attenuator Type: Tapped auto transformer. Power Rating: UL Listed @ 216 Watts Audio, 72 Watts RMS continuous. Frequency Response: 35 Hz - 20 kHz. Screw type connectors, 12 position rotary switch.

Decora® Strauss™ Stereo Volume Control

Control stereo volume from convenient wall-mounted location.



A

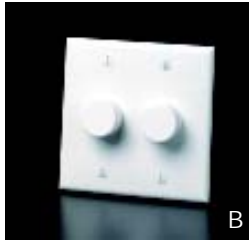

B



C



D



E



F

Decora® Strauss™ Stereo Volume Control		
Description	Ivory	White
(A) Decora® Strauss™ Stereo Volume Control, 216 Watt, 72 Watt RMS with insert, knob and plate Boxed unit pack, rack pack carton	40901-DI	40901-DW

Strauss Dual Stereo Volume Controls

Control two stereo systems at one location.

Strauss Dual Stereo Volume Control		
Description	Ivory	White
(B) Strauss Dual Stereo Volume Controls, 216 Watt, 72 Watt RMS on two gang plate Boxed unit pack, rack pack carton	40864-I	40864-W

Decora® Strauss Stereo Volume Control With A/B Switch

Provide audio source selection and volume control from a single location.

Decora® Strauss Stereo Volume Control With A/B Switch		
Description	Ivory	White
(C) Decora® Strauss Stereo Volume Control, 216 Watt, 72 Watt RMS with two gang plate Boxed unit pack, rack pack carton	40873-DI	40873-DW

Decora® Strauss Stereo Volume Control With On-Off Switch

Convenience of on-off, as well as volume control.

Decora® Strauss Stereo Volume Control With On/Off Switch		
Description	Ivory	White
(D) Decora® Strauss Stereo Volume Control, 216 Watt, 72 Watt RMS with insert, knob and plate Boxed unit pack, rack pack carton	40888-72I	40888-72W

Strauss Stereo To Mono Volume Control

Convert stereo to mono when only one speaker is being used. Control the volume from same location.

Stereo To Mono Volume Control		
Description	Ivory	White
(E) Strauss Stereo To Mono Volume Control, 216 Watt, 72 Watt RMS on plate Boxed unit pack, rack pack carton	40900-72I	40900-72W

Decora® Strauss Stereo A+B Selector Switch

2 stereo source inputs, 2 stereo speaker pair outputs. Provides the ability to choose between two separate sources, such as a receiver or an amplifier. Select either of two stereo pairs of speakers or both simultaneously.

Decora® Strauss Stereo A+B Selector Switch		
Description	Ivory	White
(F) Decora® Strauss Stereo A+B Selector Switch, 900 Watt audio, 300 Watt RMS Boxed unit pack, rack pack carton	40910-DI	40910-DW

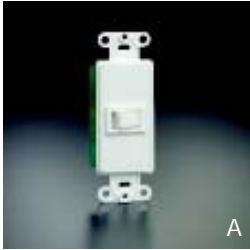

Decora® Strauss Stereo A/B Selector Switch

2 stereo source inputs, 1 stereo speaker pair output. Provides the ability to choose between two separate sources, such as a receiver or an amplifier.

Decora® Strauss Stereo A/B Selector Switch		
Description	Ivory	White
(A) Decora® Strauss Stereo A/B Selector Switch, 900 Watt audio, 300 Watt RMS Boxed unit pack, rack pack carton	40911-DI	40911-DW

Specialized Audio/Video Wallplates



Single Spring Clip Wallplate

Equipped with spade terminals. Mounted on break resistant polymer wallplate.

Single Spring Clip Wallplate		
Description	Ivory	White
(A) Single Spring Clip Wallplate Carded unit pack, rack pack carton	40951-1PI	40951-1PW

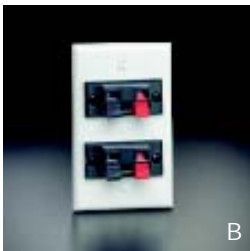

Double Spring Clip Wallplate

Equipped with spade terminals. Mounted on break resistant polymer wallplate.

Double Spring Clip Wallplate		
Description	Ivory	White
(B) Double Spring Clip Wallplate Carded unit pack, rack pack carton	40952-2PI	40952-2PW



RCA To Coax Connector Wallplate

Converts coax to RCA connector. Mounted on break resistant polymer wallplate.

RCA To Coax Connector Wallplate		
Description	Ivory	White
(C) RCA To Coax Connector Wallplate Carded unit pack, rack pack carton	40953-AI	40953-AW

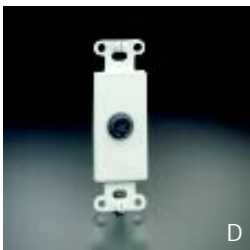

Single S-Video Decora® Insert

Metal insert requires Decora wallplate for mounting.

Single S-Video Decora® Insert		
Description	Ivory	White
(D) Single S-Video Decora® Insert Carded unit pack, rack pack carton	40954-DMI	40954-DMW



XLR Female Connector Decora® Insert

Break resistant polymer insert requires Decora wallplate for mounting.

XLR Female Connector Decora® Insert		
Description	Ivory	White
(E) XLR Female Decora® Insert Carded unit pack, rack pack carton	40955-XLI	40955-XLW

Speakers

In-Wall and Ceiling Flush-Mount Speaker Series

Acoustically-optimized and architecturally-designed, Leviton's series of in-wall and ceiling speakers is ideal for use in anything from foreground music systems to fully-equipped home theaters. Manufactured in the same facility as some prestigious "audiophile" types and with specifications verified through independent audio lab testing, Leviton speakers bring new meaning to the old phrase "value and performance."

All Leviton in-wall and ceiling series speakers incorporate long-throw, high-output woofers and ultralight polydome tweeters for exceptional clarity, detail and impact, and a low-loss precision crossover network for smooth, linear response. Leviton speakers have paintable grilles and frames for an aesthetic match with any décor and come with mounting frames for easy installation. Each speaker is acoustically engineered, or "voiced," for optimum performance when installed in walls or soffits. All are nominally rated at 8 Ohms impedance and 90dB sensitivity.

 **Enhanced**

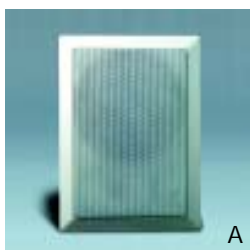

100 Watt In-Wall Flush Mount Speaker

Paintable grill and frame. 8" Woofer, 1" Polydome tweeter, 90 dB sensitivity, 8 Ohm impedance, 5,000Hz crossover frequency, 50 - 20,000Hz frequency response. Includes mounting bracket. 13' x 9" wall opening.

100 Watt In-Wall Flush Mount Speaker	
Description	White
(A) 100 Watt In-Wall Flush Mount Speaker, white Boxed unit pack	40890-WS

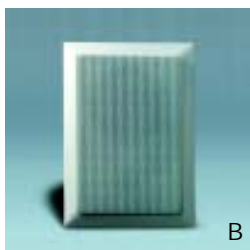

60 Watt In-Wall Flush Mount Speaker

Paintable grill and frame. 6 1/2" woofer, 1/2" Polydome tweeter, 90 dB sensitivity, 8 Ohm impedance, 6,000Hz crossover frequency, 50 - 20,000Hz frequency response. Includes mounting bracket. 9-5/8" x 6-1/4" wall opening.

60 Watt In-Wall Flush Mount Speaker	
Description	White
(B) 60 Watt In-Wall Flush Mount Speaker, white Boxed unit pack	40891-W

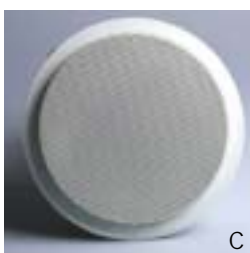

100 Watt Ceiling Mount Round Speaker

Paintable grill and frame. 6-1/2" woofer, 1/2" Polydome tweeter, 90 db sensitivity, 8 Ohm impedance, 6,000Hz crossover frequency, 50 - 20,000Hz frequency response, 8 1/2" diameter ceiling opening.

100 Watt Ceiling Mount Round Speaker	
Description	White
(C) 100 Watt Ceiling Mount Round Speaker, white Boxed unit pack	40896-W

Multi-Purpose Surface Mount Speaker

An extremely flexible performer when the specs call for true high-fidelity sound, but the situation rules out an in-wall installation. Leviton's Multi-Purpose Surface Mount speaker is designed for retrofit installations in environments that prohibit cutting such as brick or hard wall surfaces, and recreational applications such as patio and pool areas. Built for use in commercial foreground music systems, these weatherproof speakers are ideal for high-profile residential installations as well. Rated nominally at 8 Ohms impedance and 91dB sensitivity.



60 Watt Surface Mount Speaker

5 1/4" woofer. 1" Polymer Super Dome tweeter, 91 db sensitivity, 4-8 Ohm impedance, 5,000Hz crossover frequency.

60 Watt Surface Mount Speaker	
Description	Black
(A) 60 Watt Surface Mount Speaker, single Boxed unit pack	40889-E

Enhanced



100 Watt Outdoor Rock Speaker

8" Woofer. 2" dome tweeter with crossover, 77 dB Sensitivity, 8 Ohm impedance, 50 - 20,000Hz frequency response. Includes 50 ft. of direct bury 16/2 gauge speaker wire

100 Watt Outdoor Rock Speaker		
Description	Dark Gray	Lava
(A) 100 Watt Outdoor Rock Speaker, single Boxed unit pack	40827-G	40827-L



60 Watt Outdoor Rock Speaker

6-1/2" woofer, 1/2" tweeter, 77 dB sensitivity, 8 Ohm impedance, 50 - 20,000Hz frequency response. Includes 50 ft. of direct bury 16/2 gauge speaker wire.

60 Watt Outdoor Rock Speaker	
Description	Light Gray
(B) 60 Watt Outdoor Rock Speaker, Single Boxed unit pack	40828-G



100 Watt In-Ground Outdoor Speaker

Weatherproof, no conduit or PVC required. 8" polypropylene woofer, 1/2" Hardome tweeter, 77dB sensitivity, 80hm impedance, 50-20,000Hz frequency response. Includes 50ft. of direct bury 16/2 gauge speaker wire.

100 Watt Outdoor In-Ground Speaker	
Description	Green
(C) 100 Watt Outdoor In-Ground Speaker, Single Boxed unit pack	40829-GN

