

# WIREMOLD® 800 Series™ Floor Box

## 800 Series Floor Box, An Economical Single Service Solution

**Wiremold® 800 Series Semi-Adjustable Floor Box** provides an excellent and economical activation solution for the low density power or communication requirements in open space areas. 800 Series Floor Boxes are available in both stamped steel and cast iron construction and are suitable for both on or above grade applications. They also feature an aesthetic, low profile appearance that allows you to activate your wiring without obstructions. Typical applications would be in any large open space area. Activations for these boxes can be flush or pedestal type. The flush activation option offers an aesthetic brass look. 525 Series Service Fittings can be used with the 800 Series Floor Box to offer a die-cast aluminum pedestal activation. All activation covers are interchangeable for stamped steel and cast iron boxes.



800 Series steel and cast iron floor boxes.

### FEATURES & BENEFITS

- **Stamped steel construction.** Meets requirements for above grade applications. Lower cost alternative to cast iron boxes on above grade applications.
- **Activation flush or pedestal.** Flexibility to meet power or data wiring requirements. Variety of aesthetically pleasing cover options.
- **Single power receptacles available.** An inexpensive option for low density power requirements for open space areas.
- **Covers are interchangeable for cast iron and stamped steel.** More activations to meet any decor.



The aesthetic, low profile of an 800 Series Floor Box installed in a carpeted floor.

## 800 Series Floor Boxes Ordering Information

### Catalog No./Item

### Description/Specifications

**800LCK**

**Steel Floor Box** – Adjustable before and after the concrete pour.  
Sold without conversion kit. 4 3/16" W x 3" H [106mm x 76mm].



#### Technical Specifications

Conduit Knockouts	Adjustment Before Pour	Adjustment After Pour	Cubic Inch Capacity
<b>Sides</b> Two 1/2" & Two 3/4" Trade Size KOs	2 3/4" [70mm] vertical	1/2" [12.7mm] vertical	23.6 cu in. [387 cu cm]
<b>Bottom</b> Two 1/2" & Two 3/4" Trade Size KOs			

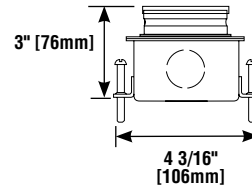
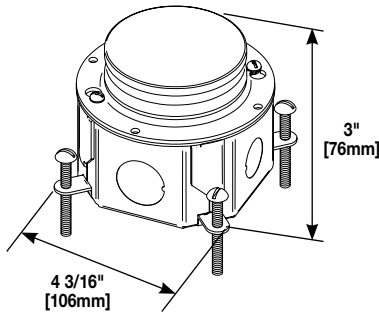

**800CILCK**

**Cast Iron Floor Box** – Adjustable before and after the concrete pour.  
Sold without conversion kit. 4 3/16" W x 3 3/8" H [106mm x 86mm].



#### Technical Specifications

Conduit Knockouts	Adjustment Before Pour	Adjustment After Pour	Cubic Inch Capacity
<b>Sides</b> Two 1/2" & Two 3/4" Trade Size KOs	2 3/4" [70mm] vertical	1/2" [12.7mm] vertical	28.3 cu in. [464 cu cm]

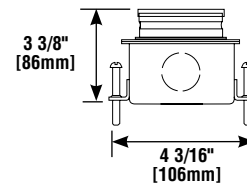
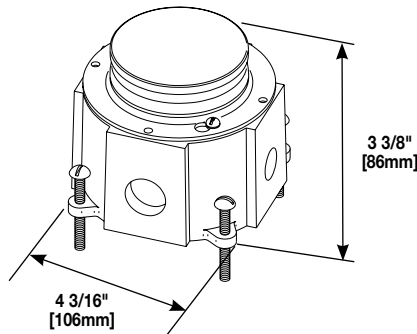

## 800 Series Floor Box Cover Plates and Accessories

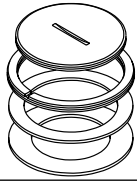
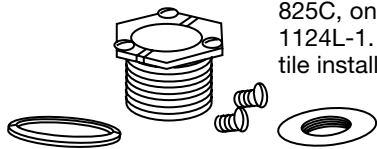
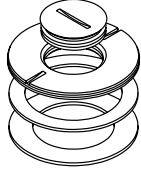
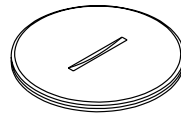
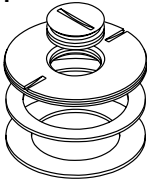
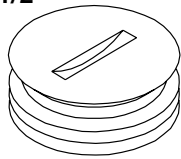
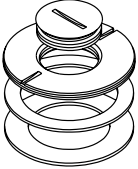
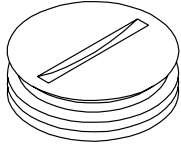
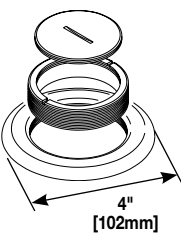
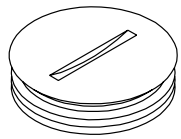
Catalog No./Item	Description/Specifications	Catalog No./Item	Description/Specifications
825CK	 <p><b>Conversion Kit</b> – Brass conversion kit which includes one 825A – 2 1/4" [57mm] diameter plug, one 825C, one 825L, and one 825N. For carpet or tile installations</p>	825SFCK	 <p><b>Conversion Kit</b> – Conversion kit to fit 525 Series Service Fitting on 800 Series Boxes. Includes one 825C, one 825P-1, and one 1124L-1. For carpet or tile installations.</p>
825CK-1	 <p><b>Conversion Kit</b> – Brass conversion kit which includes one 825A-1 – 1" [25mm] diameter plug, one 825C-1, one 825L, and one 825N. For carpet or tile installations.</p>	825A	 <p><b>Abandon Plug</b> – 2 1/4" [57mm] diameter brass abandon plug. Thread size is pipe thread size.</p>
825CK-3/4	 <p><b>Conversion Kit</b> – Brass conversion kit which includes one 825A-3/4 – 3/4" [19.1mm] diameter plug, one 825C-3/4, one 825L, and one 825N. For carpet or tile installations.</p>	825A-1/2	 <p><b>Abandon Plug</b> – 1/2" [12.7mm] diameter brass abandon plug. Thread size is pipe thread size.</p>
825CK-1/2	 <p><b>Conversion Kit</b> – Brass conversion kit which includes one 825A-1/2 – 1/2" [12.7mm] diameter plug, one 825C-1/2, one 825L, and one 825N. For carpet or tile installations.</p>	825A-3/4	 <p><b>Abandon Plug</b> – 3/4" [19.1mm] diameter brass abandon plug. Thread size is pipe thread size.</p>
825CP	 <p><b>Brass Carpet Plate Assembly</b> – Includes the 825A. Total diameter of cover is 2 5/8" [67mm].</p>	825A-1	 <p><b>Abandon Plug</b> – 1" [25mm] diameter brass abandon plug. Thread size is pipe thread size.</p>

# NOTES



**Electrical Wiring Systems**

60 Woodlawn Street  
West Hartford, CT 06110  
Phone: 1.877.BY.LEGRAND (295-3472)  
[www.legrand.us](http://www.legrand.us)

570 Applewood Crescent  
Vaughan, Ontario L4K 4B4  
Phone: 905.738.9195  
[www.legrand.ca](http://www.legrand.ca)

