

Streamline Power & Technology Connections up to the Work Surface

Wiremold® Meeting Room Solutions provide an integrated “last meter” solution for bringing power and technology closer to the user’s work area. Current trends in workplace design are allocating more open space for meetings. Those trends present a challenge for routing and managing cables over the “last meter” from the infrastructure to the point-of-use, as well as providing ready accessibility for future technology upgrades. Meeting Room Transition Channel (MRTC) and Under Table Cable Management (UTCM) were designed as part of a flexible, integrated solution set that manages cabling and connections for power, communications and A/V from the building infrastructure to the work surface.



A conference room with Under Table Cable Management and Meeting Room Transition Channel installed to manage cabling below the work surface.

FEATURES & BENEFITS

- **Multi-service integrated solutions.** Wiremold® Meeting Room Solutions work in tandem with a variety of Wiremold® pathway solutions such as OFR Series Overfloor Raceway, Fire-Classified Poke-Thru Devices and Work Surface Portals to manage A/V, communications and power cords and cables from the infrastructure to the point-of-use for a truly integrated set of solutions.
- **Ease of ordering.** UTCM and MRTC are offered in convenient kits with everything needed to complete the installation. The UTCM kit comes with 5' [1.524mm] base, 5' [1.524mm] rail and latching clips; while the MRTC kit comes with an adjustable boot, channel, mounting spine and transition covers for smooth cable egress.
- **Ultimate flexibility.** UTCM is easy to cut to length to adapt to a variety of table lengths and MRTC adjusts to a variety of table heights making installation quick and easy.
- **Adaptability.** Meeting Room Solutions are designed to allow for convenient clean up of existing tables with little or no disruption to the connected cords and cables.
- **Easy to maintain.** Future technology upgrades or room reconfigurations are completed with the least disruptions with an easy opening boot and channel on MRTC and the designed-in retaining dividers of UTCM.

MRTC covers the 'last meter' by working with a variety of Wiremold® products such as Fire Classified Poke-Thru Devices.



Transition covers on MRTC allow for smooth cable egress into the UTCM.



Meeting Room Solutions Ordering Information

Manage cords and cables under the table with easy to order, easy to install, easy to maintain
Wiremold® Meeting Room Solutions.



UTCM5 Under Table Cable Management Kit – Consists of a 5' [1.524mm] length of divided base, 5' [1.524mm] length of mounting hinge rail and four (4) latching clips. Black, nonmetallic construction.

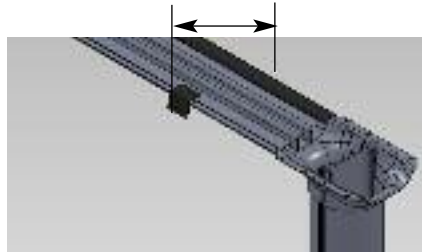

Base width without Rail & Clips: 5" [127mm]
Base width with Rail & Clips: 6 1/4" [159mm]

KIT CONTENTS:



Base



Hinge Rail



Latching Clips

QUICK INSTALLATION:

1. Cut Base (if necessary).

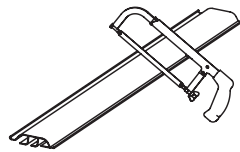

2. Mount Hinge Rail.

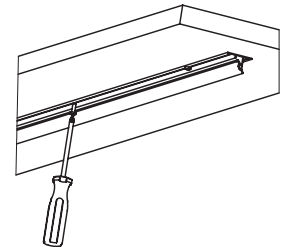

3. Install Base.

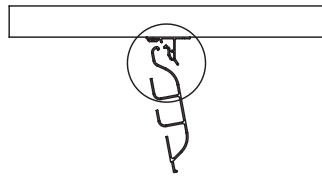

4. Locate & mount Latch Clips.

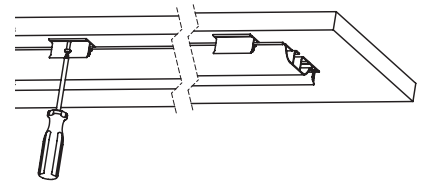

5. Load cables.

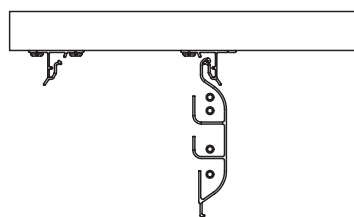

6. Create cable egress (if needed).

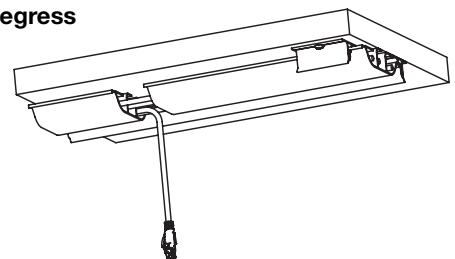

Meeting Room Solutions Ordering Information

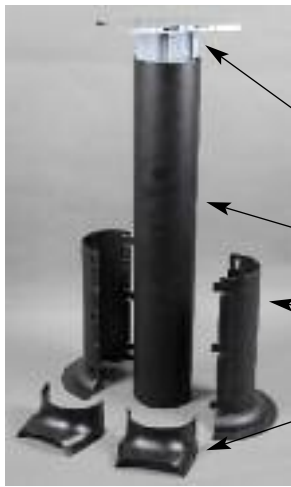

MRTC Meeting Room Transition Channel Kit – Consists of aluminum center spine with steel mounting plate and four (4) screws, black aluminum side channels, black nonmetallic bottom boot and two (2) black nonmetallic transition covers.

Center Spine with Mounting Plate

Side Channel

Bottom Boot

Transition Cover

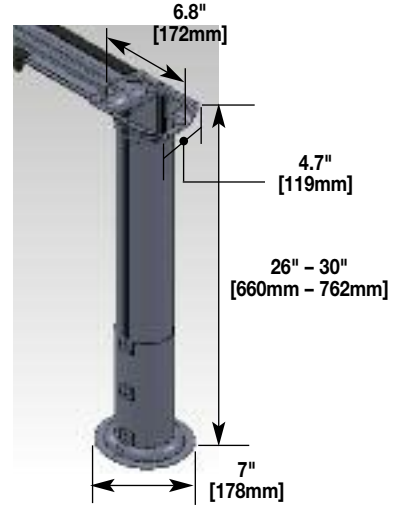

QUICK INSTALLATION:

1. Attach Spine to underside of table.

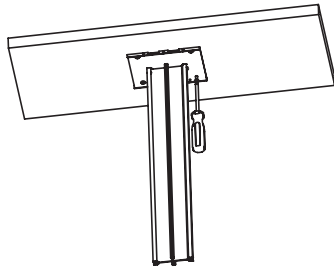

2. Snap Channels to spine around existing cables.

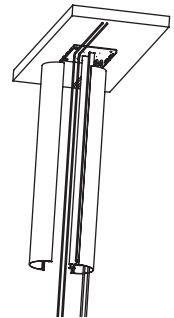

3. Attach Transition covers onto the top of the spine assembly.

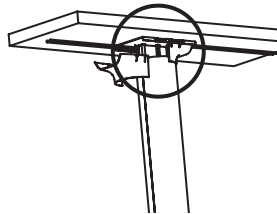

4. Snap the Boot sections together around the Channel and slide down into place on the floor.

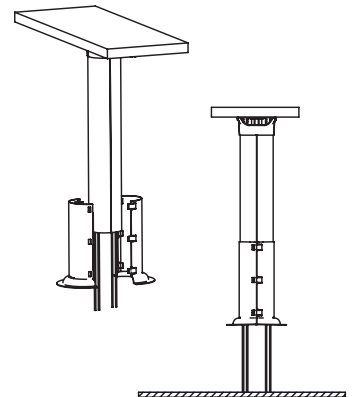

5. If the location of the Transition Channel is not directly over a poke-thru device or floor box, simply locate the opening in the edge of the Boot Flange for a guide and, using a utility knife, cut away that section of the Flange.

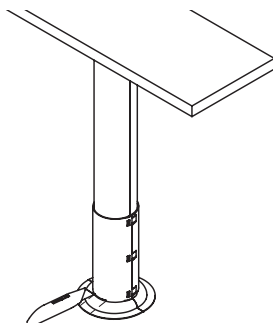

Get cables out of the way for more productive meetings with Wiremold® Meeting Room Solutions.

NOTES



60 Woodlawn Street
West Hartford, CT 06110
Phone: 1.877.BY.LEGRAND (295-3472)
www.legrand.us/wiremold
570 Applewood Crescent
Vaughan, Ontario L4K 4B4
Phone: 905.738.9195

ED1683 - October 2012 - For latest specs visit www.legrand.us/wiremold

© Copyright 2012 Legrand/Wiremold All Rights Reserved

