

Front/Rear Dual Speaker Spring Button Module

PRODUCT SPECIFICATION



Package includes:

A. Dual Speaker Spring Button Module, 1 pc

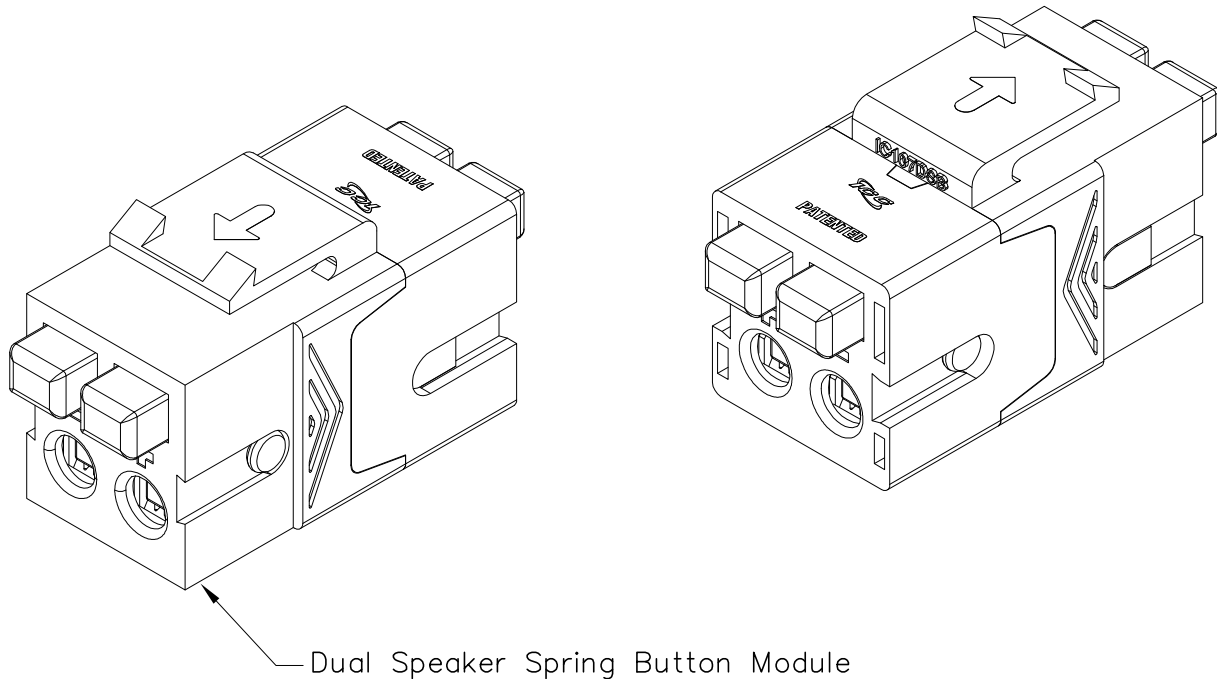

Dual Speaker Spring Button Module

Features and Benefits:

- Reduced outlet size with ½ the space required for dual speaker connections.
- Allows any 5.1, 6.1, or 7.1 surround sound home theatre system to be installed in a single gang outlet.
- Accepts up to 16 AWG speaker wire on front and rear connections.
- (+) and (-) designations on the black and red buttons for easy wire designation.
- Push button style on front and rear does not require tools to install.
- Provides a more finished professional appearance than traditional installations
- Compatible with all IC107 faceplates, inserts, surface mount boxes, and blank patch panels.
- Compatible with all IC108 furniture faceplates, bezels, and surface mount boxes.
- Available in ivory and white.

MODULE, SPEAKER, DUAL, FRONT/BACK BUTTON

ITEM NO. IC107DSBXX
 DWG NO. PS107DSB00

REV. A
 PAGE NO. 1



CUSTOMER CARE / TECHNICAL SUPPORT * CSR@ICC.COM / 888-ASK-4-ICC (275-4422) * 14700 Alondra Blvd., La Mirada, CA 90638 * www.icc.com

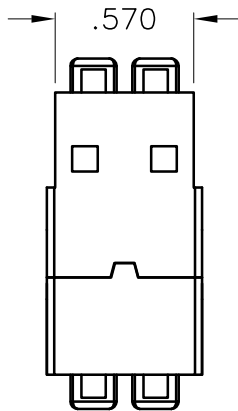
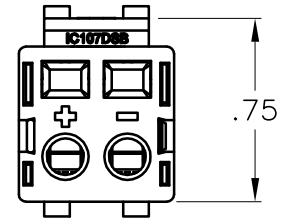
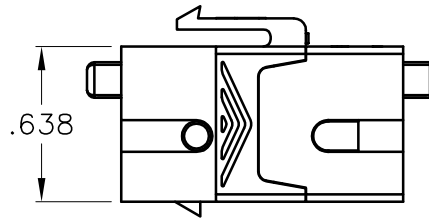
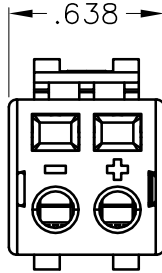
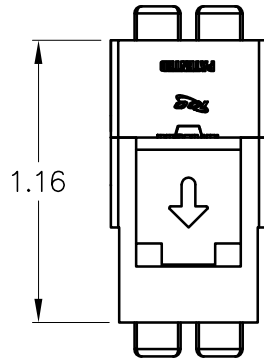

NOTE: UNLESS OTHERWISE SPECIFIED

1. ELECTRICAL RATING: 300 VOLTS MAX @ 75°C
2. ELECTRIC CURRENT: 15 AMP MAX
3. MATERIAL:
 - A. HOUSING: ABS+PC, UL 94V-0
 - B. CAM, SHAFT, PUSH BUTTONS: PC, UL 94V-0
 - C. CONTACT: TIN PLATED STEEL
4. COLOR:
 - A. HOUSING: XX: IV-IVORY, WH-WHITE
 - B. PUSH BUTTONS: 2 BLACK, 2 RED



MODULE, SPEAKER, DUAL, FRONT/BACK BUTTON		 Premium Products Proven Performance Competitive Prices	
ITEM NO.	IC107DSBXX		REV. A
DWG NO.	PS107DSB00	PAGE NO.	2

CUSTOMER CARE / TECHNICAL SUPPORT * CSR@ICC.COM / 888-ASK-4-ICC (275-4422) * 14700 Alondra Blvd., La Mirada, CA 90638 * www.icc.com