

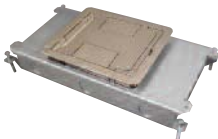

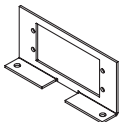

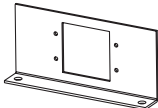

Wiremold

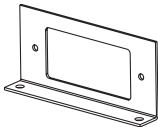
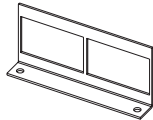
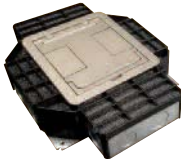
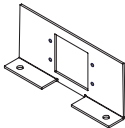
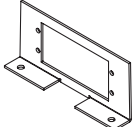
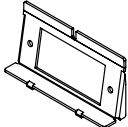
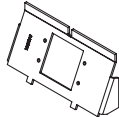
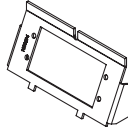
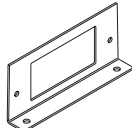

# Wiremold Pathways

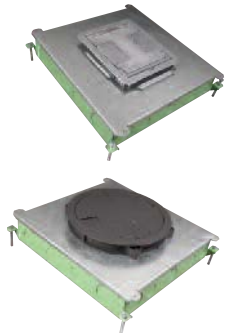
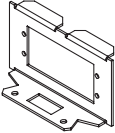
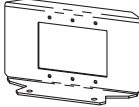
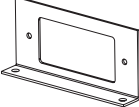
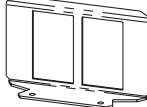
## A/V COMPATIBLE DEVICE PLATES

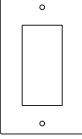
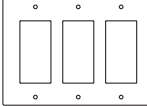
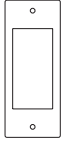
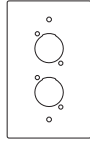
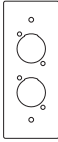

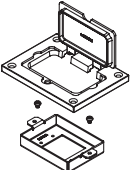
FLOOR BOXES	A/V PART NUMBER(S)	LINE ART	DESCRIPTION	PRODUCT INFORMATION
<b>Resource RFB® Series Floor Boxes</b>				
<b>RFB2 Series</b> 	RFB2-AAP		RFB2 Device Plate w/Extron® Electronics AAP opening.	Current Version of: ED771, ED1559
	RFB2EXT		RFB2 Device Plate w/Extron® Electronics MAAP opening.	
	RFB2GFI		RFB2 Device Plate w/GFCI or decorator style opening for open A/V devices such as Extron® Electronics, Crestron® and Atinex® Intera.	
	RFB2RT		RFB2 Device Plate w/bracket that accepts Ortronics® Series II Devices.	
<b>RFB4 Series</b> 	RFB4-SS-MAAP		RFB4 Shallow Device Plate w/Extron® Electronics MAAP opening.	Current Version of: ED771, ED1559
	RFB4-SS-AAP		RFB4 Shallow Device Plate w/Extron® Electronics AAP opening.	
	RFB-GFI-4DB		RFB4-4DB Device Plate w/GFCI or decorator style opening for open A/V devices such as Extron® Electronics, Crestron® and Atinex® Intera.	
	WTB-MAAP		RFB4-4DB Device Plate w/Extron® Electronics MAAP opening.	
	WTB-AAP		RFB4-4DB Device Plate w/Extron® Electronics AAP opening.	
	RFB-GFI-SS		RFB4 Shallow Device Plate w/GFCI or decorator style opening for open A/V devices such as Extron® Electronics, Crestron® and Atinex® Intera.	

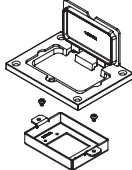
**NOTE:** Wiremold manufactures many additional pathway solutions. Those represented here have been designed/modified to provide the depth behind the plate required for most A/V devices. For additional design and installation considerations, please see our A/V Compatibility Quick Selection Guide (current version of ED1596) or contact the factory.

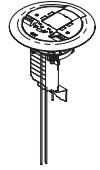
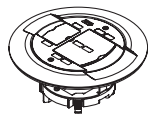

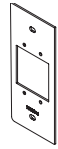
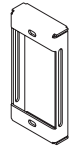
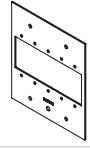
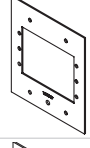
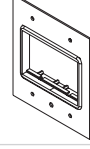
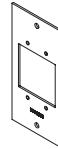
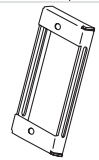

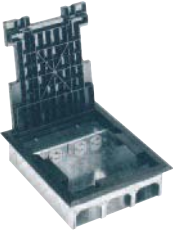
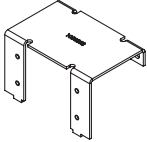
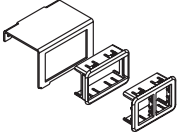

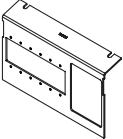
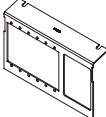
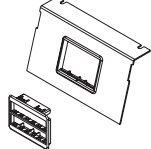
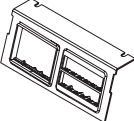
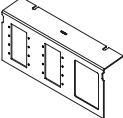
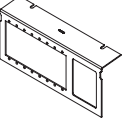
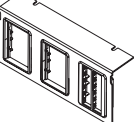
FLOOR BOXES (continued)	A/V PART NUMBER(S)	LINE ART	DESCRIPTION	PRODUCT INFORMATION
<b>Resource RFB® Series Floor Boxes</b>				
	RFB6-AAP		RFB6 Device Plate w/ Extron® Electronics AAP opening.	Current Version of: ED771, ED1559
	RFB6EXT		RFB6 Device Plate accepts three (3) Extron® Electronics MAAP Devices.	
	RFB6GFI		RFB6 Device Plate w/GFCI or decorator style opening for open A/V devices such as Extron® Electronics, Crestron® and Atinex® Intera.	
	RFB6RT		RFB6 Device Plate w/adaptor to accept two (2) Ortronics® Series II Devices.	
	RFB119-GFI		RFB119 Device Plate w/GFCI or decorator style opening for open A/V devices such as Extron® Electronics, Crestron® and Atinex® Intera.	Current Version of: ED1242
	RFB119-3GFI		RFB119 Device Plate w/three (3) GFCI or decorator style openings for open A/V devices such as Extron® Electronics, Crestron® and Atinex® Intera.	
	RFB119-SGFI		RFB119 Device Plate w/GFCI or decorator style opening for open A/V devices such as Extron® Electronics, Crestron® and Atinex® Intera.	
	RFB119-XLR		RFB119 Device Plate w/two (2) openings to accept microphone devices.	
	RFB119-SXLR		RFB119 Device Plate w/two (2) openings to accept microphone devices.	
<b>OmniBox™ Series Floor Boxes</b>				
	828-MAAP		Device Plate for mounting Extron® Electronics MAAP Devices using 828GFI Covers. For use with 828GFITC or 828GFITCAL Cover Plates (sold separately).	Current Version of: ED772

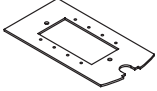
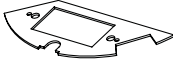
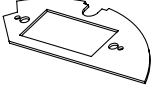
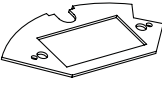
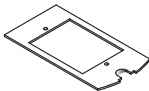
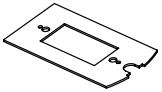

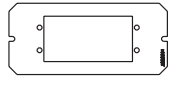
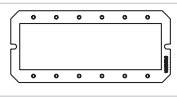
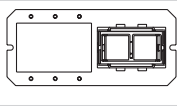
<b>FLOOR BOXES</b> (continued)	<b>A/V</b> <b>PART NUMBER(S)</b>	<b>LINE ART</b>	<b>DESCRIPTION</b>	<b>PRODUCT</b> <b>INFORMATION</b>
<b>880W Series™ Floor Boxes</b>				
	828-MAAP		Device Plate for mounting Extron® Electronics MAAP Devices using 828GFI Covers. For use with 828GFITC or 828GFITCAL Cover Plates (sold separately).	Current Version of: ED770
<b>Ratchet-Pro 881 Series Floor Boxes</b>				
	881AV3CTCGY 881AV3CTCBK 881AV3CTCAL 881AV3CTCBS		Floor Box Cover Kit with Extron® Electronics MAAP and Ortronics® Series II Adapters.	Current Version of: ED744
	881AMD8CTCGY 881AMD8CTCBK 881AMD8CTCAL 881AMD8CTCBS		Floor Box Cover Kit with Ortronics® Series II Adapters.	

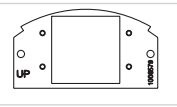
<b>RAISED FLOOR BOXES</b>	<b>A/V</b> <b>PART NUMBER(S)</b>	<b>LINE ART</b>	<b>DESCRIPTION</b>	<b>PRODUCT</b> <b>INFORMATION</b>
<b>AF™ Series Raised Floor Boxes</b>				
	AF-1 AF-3			Current Version of: ED670
	SGT-MAAP		SGT Device Plate w/Extron® Electronics MAAP opening.	
	SGT-3S2		SGT Device Plate accepts three (3) Ortronics® Series II Devices.	
	DGT-MAAP		DGT Device Plate w/Extron® Electronics MAAP opening.	
	DGT-AAP		DGT Device Plate w/Extron® Electronics AAP opening.	
	DGT-RT		DGT Device Plate includes one (1) Ortronics® Series II Adapter.	
	SGB-MAAP		SGB Device Plate w/Extron® Electronics MAAP opening.	
SGB-3S2			SGB Device Plate accepts three (3) Ortronics® Series II Devices.	

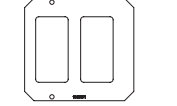
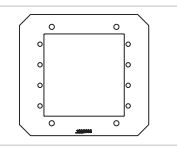
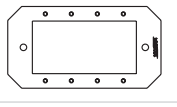
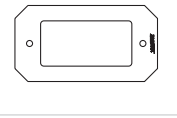
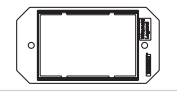
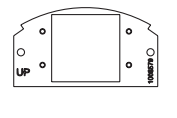

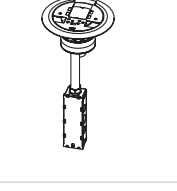
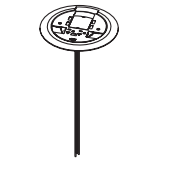

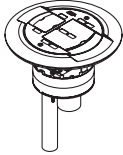
RAISED FLOOR BOXES (continued)	A/V PART NUMBER(S)	LINE ART	DESCRIPTION	PRODUCT INFORMATION
<b>AF™ Series Raised Floor Boxes</b>				
	SGC2-MAAP		SGC2 Device Plate accepts two (2) Extron® Electronics MAAP Devices.	
	SGC2-RT		SGC2 Device Plate with Adapter that accepts one (1) Ortronics® Series II Device.	
<b>AC™ Series Floor Boxes</b>				
	C8005P-MAAP-6A		C8005P Device Plate w/Extron® Electronics MAAP opening.	Current Version of: ED670
	C8005P-AAP-6A		C8005P Device Plate w/Extron® Electronics AAP opening.	
	C8005P-RT C8005P-2RT C8005P-3RT		C8005P Device Plate w/Adapters for one (1), two (2), or three (3) Ortronics® Series II Devices.	
	C8004P-2RT		C8004P Device Plate w/Adapters for two (2) Ortronics® Series II Devices.	
	C10105P-MAAP-6A		C10105P Device Plate w/Extron® Electronics MAAP opening.	
	C10105P-AAP-6A		C10105P Device Plate w/Extron® Electronics AAP opening.	
	C10105P-3RT		C10105P Device Plate w/Adapters for three (3) Ortronics® Series II Devices.	

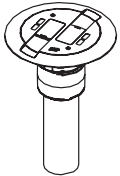
RAISED FLOOR BOXES (continued)	A/V PART NUMBER(S)	LINE ART	DESCRIPTION	PRODUCT INFORMATION
<b>CRFB Series Floor Boxes</b>				
	CRFB-CMAAP		CRFB Device Plate w/Extron® Electronics MAAP opening.	Current Version of: ED670
	CRFB-GFI-1		CRFB Device Plate w/standard GFCI or decorator style opening for open A/V devices such as Extron® Electronics, Crestron® and Atinex® Intera.	
	CRFB-GFI-2		CRFB Device Plate w/standard GFCI or decorator style opening for open A/V devices such as Extron® Electronics, Crestron® and Atinex® Intera.	
	CRFB-GFI-3		CRFB Device Plate w/standard GFCI or decorator style opening for open A/V devices such as Extron® Electronics, Crestron® and Atinex® Intera.	
	CRFB-BEZ-6A		CRFB Device Plate w/Adapter for one (1) Ortronics® Series II Device.	
	CRFB-CGFI		CRFB Device Plate w/standard GFCI or decorator style opening for open A/V devices such as Extron® Electronics, Crestron® and Atinex® Intera.	

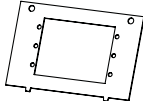
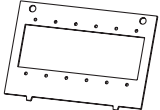
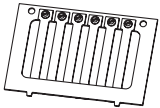
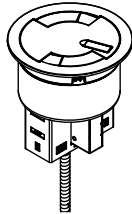
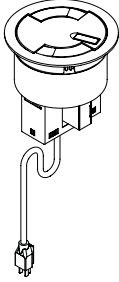

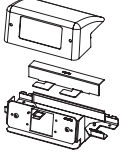
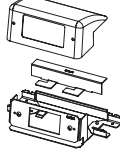
POKE-THRU DEVICES	A/V PART NUMBER(S)	LINE ART	DESCRIPTION	PRODUCT INFORMATION
<b>Evolution™ Series Poke-Thru Devices</b>				
	6AAP		Device Plate accepts two (2) Extron® Electronics AAP Devices.	Current Version of: ED1543
	6MAAP		Device Plate accepts six (6) Extron® Electronics MAAP Devices.	
	6MAAP2A		Device Plate accepts three (3) Extron® Electronics MAAP Devices and up to two (2) ports for communication devices.	
	6DEC		Device Plate accepts standard GFCI or decorator style opening for open A/V devices such as Extron® Electronics, Crestron® and Atinex® Intera.	
	6SER		Device Plate accepts up to four (4) Ortronics® Series II modular inserts.	
	68MAAP		Device Plate accepts up to two (2) Extron® Electronics MAAP Devices.	
	8CREST		Device Plate accepts Crestron® & Extron® Electronics double gang decorator style devices.	Current Version of: ED1543
	8AAP		Device Plate accepts four (4) Extron® Electronics AAP Devices.	
	8MAAP		Device Plate accepts four (4) Extron® Electronics MAAP Devices.	
	8DEC		Device Plate with standard GFCI or decorator style opening for open A/V devices such as Extron® Electronics, Crestron® and Atinex® Intera.	
	8SER		Device Plate accepts up to three (3) Ortronics® Series II modular inserts.	
	68MAAP		Device Plate accepts up to two (2) Extron® Electronics MAAP Devices.	
<b>AV3 Series™ Poke-Thru Devices</b>				
	AV3ATCGY AV3ATCBK AV3ATCAL AV3ATCAA AV3ATCBS AV3ATCAB AV3ATCVY		Assembled Poke-Thru Device that includes bezels to accepts one Extron® Electronics MAAP device or one Ortronics® Series II insert.	Current Version of: ED1215
	AV3CTCGY AV3CTCBK AV3CTCAL AV3CTCAA AV3CTCBS AV3CTCAB AV3CTCVY		Assembled Poke-Thru Device that includes bezels to accepts one Extron® Electronics MAAP device or one Ortronics® Series II insert.	

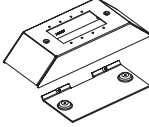
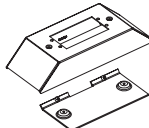
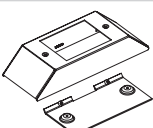

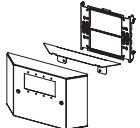
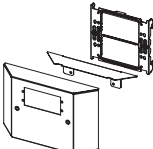
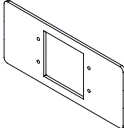
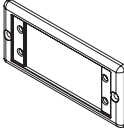
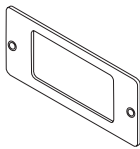
<b>POKE-THRU DEVICES</b> (continued)	<b>A/V PART NUMBER(S)</b>	<b>LINE ART</b>	<b>DESCRIPTION</b>	<b>PRODUCT INFORMATION</b>
<b>AMD8 Series™ Poke-Thru Devices</b>				
	AMD8ATCGY AMD8ATCBK AMD8ATCAL AMD8ATCAA AMD8ATCBS AMD8ATCAB AMD8ATCVY		Assembled Poke-Thru Device that includes bezels to accept four (4) Ortronics® Series II inserts.	Current Version of: ED1215
<b>RC9AMD Series™ Poke-Thru Devices</b>				
	RC9AMDTCGY RC9AMDTCBK RC9AMDTCAL RC9AMDTCBS RC9AMDTCAB RC9AMDTCVY RC9AMDTCAA		Assembled Poke-Thru Device that includes bezels to accept two (2) Ortronics® Series II inserts.	Current Version of: ED1215

<b>WORK SURFACE SOLUTIONS</b>	<b>A/V PART NUMBER(S)</b>	<b>LINE ART</b>	<b>DESCRIPTION</b>	<b>PRODUCT INFORMATION</b>
<b>deQuorum™ Work Surface Portals</b>				
	KA305-AAP		Device Plate w/Extron® Electronics AAP Opening.	Current Version of: ED1163
	KA305		Device Plate w/Extron® Electronics MAAP Opening.	
	KA302		Device Plate holds cables captive for easy access when active jacks are not needed.	
<b>Evolution™ Series Work Surface Portals</b>				
<b>WSF6 Series</b>	<b>FIELD-WIRED</b> WSF6FNK, WSF6FBS, WSF6FGY, WSF6FBK, WSF6FBZ, WSF6SNK, WSF6SBS, WSF6SGY, WSF6SBK, WSF6SBZ, <b>CORD-ENDED</b> WS6FNK, WS6FBS, WS6FGY, WS6FBK, WS6FBZ, WS6SNK, WS6SBS, WS6SGY, WS6SBK, WS6SBZ,	Field-Wired 	6" [152mm] Field-Wired or Cord-Ended Work Surface Portals that can accept up to five (5) Extron® Electronics MAAP device plates.	Current Version of: ED1616
<b>WSF8 Series</b>	<b>FIELD-WIRED</b> WSF8FNK, WSF8FBS, WSF8FGY, WSF8FBK, WSF8FBZ, WSF8SNK, WSF8SBS, WSF8SGY, WSF8SBK, WSF8SBZ, <b>CORD-ENDED</b> WS8FNK, WS8FBS, WS8FGY, WS8FBK, WS8FBZ, WS8SNK, WS8SBS, WS8SGY, WS8SBK, WS8SBZ,	Cord-Ended 	8" [203mm] Field-Wired or Cord-Ended Work Surface Portals that can accept up to ten (10) Extron® Electronics MAAP device plates.	

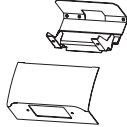
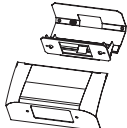
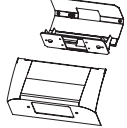
PERIMETER SYSTEMS	A/V PART NUMBER(S)	LINE ART	DESCRIPTION	PRODUCT INFORMATION
<b>Steel Raceway Systems</b>				
<b>2400 Series™ Raceway</b> 	V24DWNU 24DWNU-FW		Downward-Facing Device Plate w/Extron® Electronics MAAP opening.	Current Version of: ED874
	V24DWNS 24DWNS-FW		Downward-Facing Device Plate w/Ortronics® Series II opening.	
<b>3000® Series Raceway</b> 	V3046U G3046U		Bump-Up Device Plate w/Extron® Electronics MAAP opening.	Current Version of: ED528
	V3046V G3046V		Bump-Up Device Plate w/Extron® Electronics AAP opening.	
	V3046S G3046S		Bump-Up Device Plate w/Ortronics® Series II opening.	
<b>4000® Series Raceway</b> 	V4047UX G4047UX		Bump-Up Device Plate w/Extron® Electronics MAAP opening.	Current Version of: ED531
	V4047VX G4046VX		Bump-Up Device Plate w/Extron® Electronics AAP opening.	
	5507MAAP 5507MAAP-G		5507 Series Device Plate w/Extron® Electronics MAAP opening.	
	5507AAP 5507AAP-G		5507 Series Device Plate w/Extron® Electronics AAP opening.	
	5507R 5507R-G		5507 Series Device Plate w/decorator style opening for open A/V devices such as Extron® Electronics, Crestron® and Atinex® Intera.	

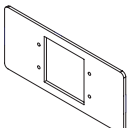
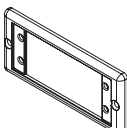
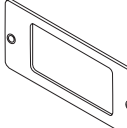
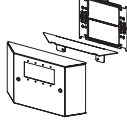
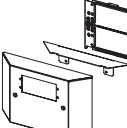

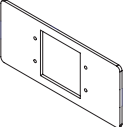
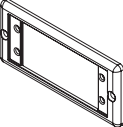
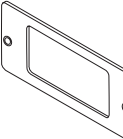

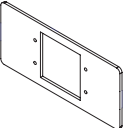
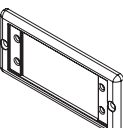
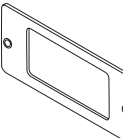

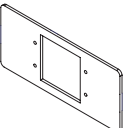
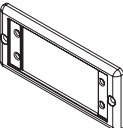
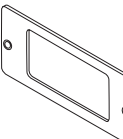

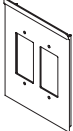
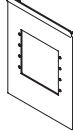
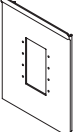
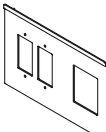
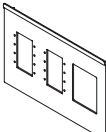
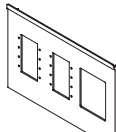
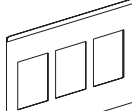
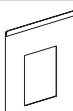
PERIMETER SYSTEMS (continued)	A/V PART NUMBER(S)	LINE ART	DESCRIPTION	PRODUCT INFORMATION
<b>Steel Raceway Systems (continued)</b>				
<b>DS4000® Series Raceway</b> 	DSDWNR-BK DSDWNR-BZ DSDWNR-DG DSDWNR-DV		Downward-Facing Device Plate w/ decorator style opening for open A/V devices such as Extron® Electronics, Crestron® and Atinex® Intera.	Current Version of: ED1444
	DSDWNS-BK DSDWNS-BZ DSDWNS-DG DSDWNS-DV		Downward-Facing Device Plate w/Ortronics® Series II opening.	
	DSDWNU-BK DSDWNU-BZ DSDWNU-DG DSDWNU-DV		Downward-Facing Device Plate w/Extron® Electronics MAAP opening.	
<b>6000® Series Raceway</b> 	5507MAAP 5507MAAP-G		5507 Series Device Plate w/Extron® Electronics MAAP opening.	Current Version of: ED530
	5507AAP 5507AAP-G		5507 Series Device Plate w/Extron® Electronics AAP opening.	
	5507R, 5507R-G		5507 Series Device Plate w/decorator style opening for open A/V devices such as Extron® Electronics, Crestron® and Atinex® Intera.	
	V4047UX G4047UX		Bump-Up Device Plate w/Extron® Electronics MAAP opening.	
	V4047VX G4047VX		Bump-Up Device Plate w/Extron® Electronics AAP opening.	

PERIMETER SYSTEMS (continued)	A/V PART NUMBER(S)	LINE ART	DESCRIPTION	PRODUCT INFORMATION
<b>Nonmetallic Raceway Systems</b>				
<b>5400 Series™ Raceway</b> 	5507MAAP 5507MAAP-FW 5507MAAP-WH 5507MAAP-BK 5507MAAP-G 5507MAAP-GY		5507 Series Device Plate w/Extron® Electronics MAAP opening.	Current Version of: ED467
	5507AAP 5507AAP-FW 5507AAP-WH 5507AAP-BK 5507AAP-G 5507AAP-GY		5507 Series Device Plate w/Extron® Electronics AAP opening.	
	5507R 5507R-FW 5507R-WH 5507R-BK 5507R-G 5507R-GY		5507 Series Device Plate w/decorator style opening for open A/V devices such as Extron® Electronics, Crestron® and Atinex® Intera.	
<b>5500 Series™ Raceway</b> 	5507MAAP, 5507MAAP-FW, 5507MAAP-WH, 5507MAAP-BK, 5507MAAP-G, 5507MAAP-GY		5507 Series Device Plate w/Extron® Electronics MAAP opening.	Current Version of: ED365
	5507AAP, 5507AAP-FW, 5507AAP-WH, 5507AAP-BK, 5507AAP-G, 5507AAP-GY		5507 Series Device Plate w/Extron® Electronics AAP opening.	
	5507R, 5507R-FW, 5507R-WH, 5507R-BK, 5507R-G, 5507R-GY		5507 Series Device Plate w/decorator style opening for open A/V devices such as Extron® Electronics, Crestron® and Atinex® Intera.	

IN WALL SYSTEMS	A/V PART NUMBER(S)	LINE ART	DESCRIPTION	PRODUCT INFORMATION
<b>WallSource™ Multiple Service Boxes</b>				
	5507MAAP, 5507MAAP-FW, 5507MAAP-WH, 5507MAAP-BK, 5507MAAP-G, 5507MAAP-GY		5507 Series Device Plate w/Extron® Electronics MAAP opening.	Current Version of: ED864
	5507AAP, 5507AAP-FW, 5507AAP-WH, 5507AAP-BK, 5507AAP-G, 5507AAP-GY		5507 Series Device Plate w/Extron® Electronics AAP opening.	
	5507R, 5507R-FW, 5507R-WH, 5507R-BK, 5507R-G, 5507R-GY		5507 Series Device Plate w/decorator style opening for open A/V devices such as Extron® Electronics, Crestron® and Atinex® Intera.	

VERTICAL SOLUTIONS	A/V PART NUMBER(S)	LINE ART	DESCRIPTION	PRODUCT INFORMATION
	VSCR		Crestron® & Extron® Electronics Double-Gang Decorator Style Device Plate for Small Vista Columns.	Current Version of: ED1133
	VSEA		Device Plate w/Extron® Electronics AAP opening for Small Vista Columns.	
	VSEM		Device Plate w/Extron® Electronics MAAP opening for Small Vista Columns.	
	VLCR		Crestron® & Extron® Electronics Double-Gang Decorator Style Device Plate for Large Vista Columns.	
	VLEA		Device Plate w/Extron® Electronics AAP opening for Large Vista Columns.	
	VLEM		Device Plate w/Extron® Electronics MAAP opening for Large Vista Columns.	
	VLRT		Device Plate w/opening for three (3) Ortronics® Series II devices for Large Vista Columns.	
	VSRT		Device Plate w/opening for one (1) Ortronics® Series II device for Small Vista Columns.	

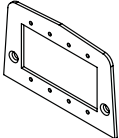
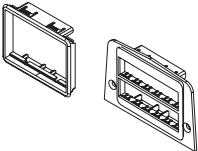
VERTICAL SOLUTIONS (continued)	A/V PART NUMBER(S)	LINE ART	DESCRIPTION	PRODUCT INFORMATION
<b>Tele-Power® Poles</b>				
	30TP-MAAP		Device Plate w/Extron® Electronics MAAP opening.	Current Version of: ED420
	30TP-L		Device Plate w/Extron® Electronics AAP opening.	
	30TP-AAP		Device Plate w/GFCI or decorator style opening for open A/V devices such as Extron® Electronics, Crestron® and Atinex® Intera.	

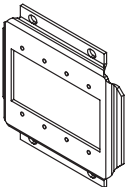
INFLOOR SYSTEMS	A/V PART NUMBER(S)	LINE ART	DESCRIPTION	PRODUCT INFORMATION
<b>525 Series™ Service Fittings – For use with Walkerdect® Underfloor Duct Systems</b>				
	500-MAAP		525 Series Device Plate w/Extron® Electronics MAAP opening.	Current Version of: ED1225
	500RT		525 Series Device Plate w/opening for one (1) Ortronics® Series II Device.	
<b>Multiplex™ Series Service Fittings – For use with Walkerdect® Underfloor Duct Systems</b>				
	LTF48-MAAP		Multiplex Series Device Plate w/Extron® Electronics MAAP opening.	Current Version of: ED667

**NOTE:** Wiremold manufactures many additional pathway solutions. Those represented here have been designed/modified to provide the depth behind the plate required for most A/V devices. For additional design and installation considerations, please see our A/V Compatibility Quick Selection Guide (current version of ED1596) or contact the factory.



**Wiremold**

**WIREMOLD**

U.S. and International:  
 60 Woodlawn Street • West Hartford, CT 06110  
 1-800-621-0049 • FAX 860-232-2062 • Outside U.S. 860-233-6251  
 Canada:  
 570 Applewood Crescent • Vaughan, Ontario L4K 4B4  
 1-800-723-5175 • FAX 905-738-9721

