

Economical and Vandal Resistant Hot-Line Phones



K-1900D-2



K-1900W-2



K-1900-6

The **K-1900** Series of Hot-Line phones are programmable to dial a 1-20 digit telephone number each time the phone's handset is lifted. The products may be programmed to Touch Tone or pulse dial and will not dial on incoming calls.

The **K-1900** Series phones are available in a desk or wall chassis, as well as in a vandal resistant panel phone configuration. A network insert dialer is also available, to convert standard phones into hot-line phones.



K-1900-7

Features

- Telephone line powered
- Hearing aid compatible amplified handsets
- Rotary handset volume control
- 1 - 20 digit programmable speed dial number
- Touch Tone and 10/20 pps pulse dialing
- Non-volatile E² memory (no batteries required)
- Restricts fraudulent calls from hand held dialers
- Optional **Q170600** ringer (**Fax Back Doc 845**)
- Operates on a C.O. line or analog PABX/KSU extensions
- Ring detection (will not dial on incoming calls)
- Programmable security code to enter programming
- Touch Tone programmable
- **K-1900-6** fits standard 500, 554, 2500 and 2554 set phones

Applications

- Catalog sales
- Information kiosks in malls
- Courtesy and customer service phones
- Automated tellers
- Hot-line reservation phones
- Replace leased Ringdown circuits
- Security and emergency phones (pools, etc.)



Sold by:
TWAcomm.com
<http://www.TWAcomm.com>
Toll Free: (877) 892-2666

Phone...715.386.8861

info@vikingelectronics.com

<http://www.vikingelectronics.com>

Specifications

Power: Telephone line powered (20V DC/18mA minimum)
Environmental: 0°C to 32°C (32°F to 90°F) with 5% to 95% non-condensing humidity
Dimensions: (see page 2)
Dialing Speed: Normal - 120ms tones/10 pps, Fast - 50ms tones/20 pps

Specifications and Installation

Viking offers three variations of hot-line phones and one network dialer. Below are model numbers and descriptions of the Hot Line phones Viking offers. Each model is designed for specific applications, including varying mounting capabilities and levels of vandal protection. The following sections describe the product model numbers, their applications, installation and specifications.

K-1900D-2 Hot Line Desk Phone

To install the **K-1900D-2**, insert the RJ11 plug into a standard RJ11 jack as shown to the right.

Dimensions: 230mm x 210mm x 120mm (9.0" x 8.25" x 4.75")

Shipping Weight: 1.36 Kg (3 lbs)

Connections: RJ11

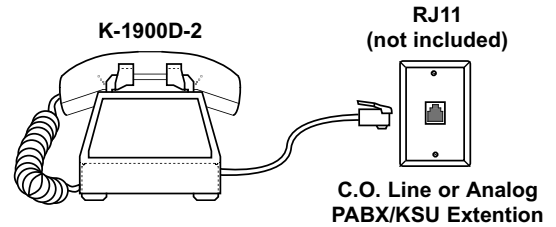

K-1900W-2 Hot Line Wall Phone

To install the **K-1900W-2**, line up the pins of the RJ11W jack with the slots on the back of the phone, insert and press down as shown to the right.

Dimensions: 102mm x 108mm x 222mm (4.0" x 4.25" x 8.75")

Shipping Weight: 1.36 Kg (3 lbs)

Connections: RJ11W

Optional **VE-9x12** Weatherproof Housing for the **K-1900W-2**, available in emergency red or safety yellow. For more information on the **VE-9x12**, retrieve **Fax Back Document 413**.

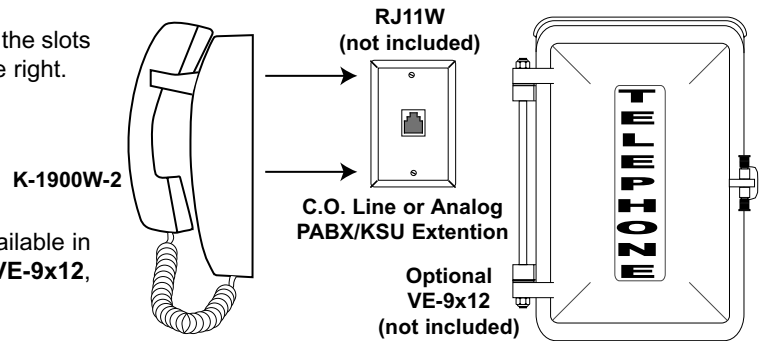

K-1900-6 Hot Line Dialer Network

The **K-1900-6** Hot-Line Dialer Network can be used with any carbon microphone handset and a double pole hook switch or typical 500, 554, 2500 and 2554 phones. Attach wires as shown to the right.

Required Handset Type: Carbon microphone
Required Hookswitch: One normally open contact and one normally closed contact

Dimensions: 88.9mm x 68.6mm x 33mm (3.5" x 2.7" x 1.3")

Shipping Weight: 0.45 Kg (1.0 lb)

Connections: Miniature spade receptacles

Compatible Phones: 500, 554, 2500 and 2554

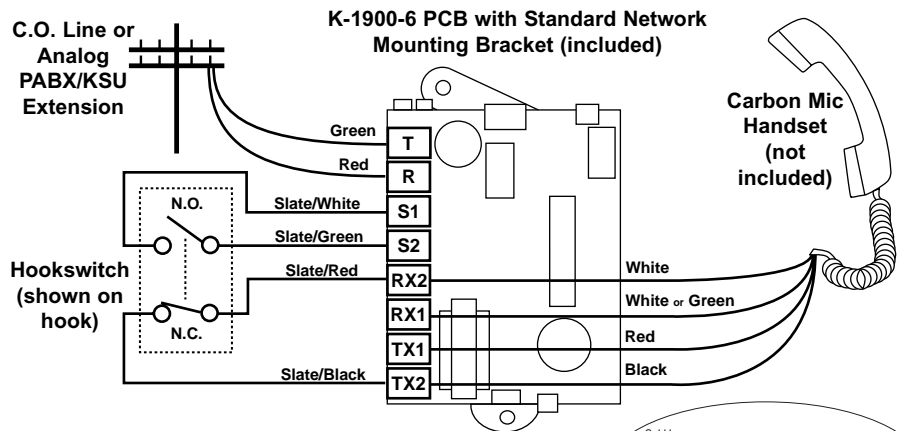

K-1900-7 Hot Line Panel Phone

To install the **K-1900-7** vandal resistant hot line panel phone, attach the panel to an existing double gang box (with minimum dimensions shown right) using the provided screws or use the optional **VE-5x10** weather resistant surface mount box. Insert a cord into the RJ11 jack on the back of the **K-1900-7**. **Note:** Four extra screws and nuts are provided to fill the unused mounting holes.

Dimensions: 127mm x 254mm x 102mm (5" x 10" x 4")

Shipping Weight: 1.36 Kg (3 lbs)

Connections: RJ-11

Panel Material: .125 inch stainless steel

Mounting: Flush mounted to a double gang box

For more information on the optional **VE-5x10 Surface Mount Box**, retrieve **Fax Back Document 424**. (10.14" x 5.22" x 3.69")

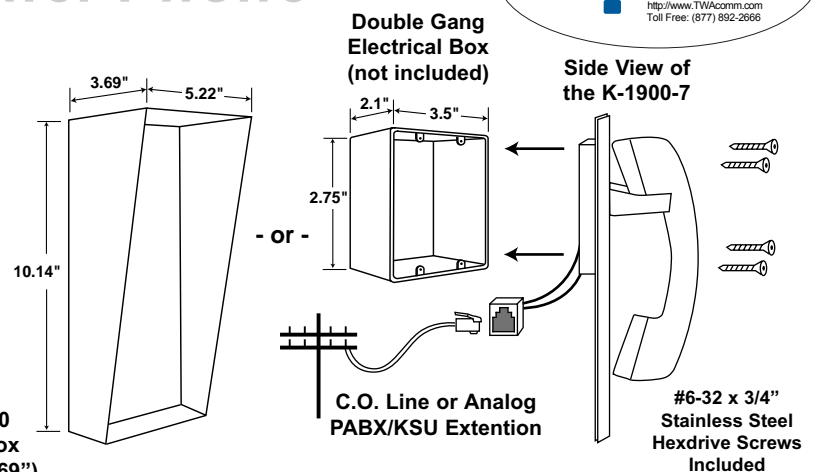

Programming

While in the programming mode, two beeps indicate a valid programming entry. An invalid entry will be indicated with three beeps. To exit programming, simply hang-up the **K-1900** Series phone.

A. Accessing the Programming Mode

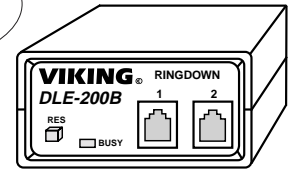

DLE-200B Line Simulator
(not included)

1. Using the Security Code

- Connect the **K-1900** Series device to a C.O. line, analog PABX/KSU station or to a **DLE-200B** Line Simulator (**Fax Back Document 605**).
- From a Touch Tone phone, call into the **K-1900** Series phone.
- Listen for at least one ringback in the calling phone and then take the **K-1900** Series phone off-hook (answer the phone).
- From the Touch Tone phone, enter your six digit security code, factory set to **845464** (see section **E**).
- A double beep indicates the **K-1900** Series phone is in the programming mode (see sections **B-G**). If six digits are entered and no beeps are heard, an incorrect security code has been entered. Repeat steps **b-e** or follow directions in **2. Without a Security Code** below.

2. Without a Security Code (If You Have Forgotten or Lost the Security Code)

- Remove **JP1** (as shown to the right). For the **K-1900W-2** and **K-1900D-2**, the plastic cover must be removed to expose the circuit board.
- Connect the **K-1900** Series device to a C.O. line, analog PABX/KSU station or to a **DLE-200B** Line Simulator.
- From a Touch Tone phone, call into the **K-1900** Series phone.
- Listen for at least one ringback in the calling phone and then take the **K-1900** Series phone off-hook (answer the phone).
- A double beep indicates the **K-1900** Series phone is in the programming mode (see **Programming** sections **B-G**).
- When programming is finished, replace **JP1** and replace cover on phone.

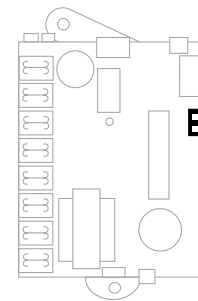

JP1
Remove to enter programming without a security code.

Note: **JP1** **MUST** be in place for normal operation.

B. Programming Features

Programming Features for the K-1900 Series	Enter Digits	Enter Memory Location
Speed dial number (see section F , example 1) 1-20 digits or pauses	phone number	#0
To add a * anywhere in the dialing string	**	
To add a # anywhere in the dialing string	*#	
To set dialing speed to normal - 120ms tones/10 pps (factory setting)	*1	
To set dialing speed to fast - 50ms tones/20pps	*2	
To restrict Touch Tone user dialing (factory setting)	*3	
To enable Touch Tone user dialing	*4	
Toggles between pulse and Touch Tone dialing (see section C , example 2)	*6	
To add a 4 second pause anywhere in the dialing string (see section C , example 3)	*7	
To add a 1 second pause anywhere in the dialing string	*8	
Security Code, factory set to 845464 (see section E)	6 digits (1-9)	#9

C. Programming Examples

Programming the K-1900 Series	Enter Digits
1. ...to Touch Tone dial 555-1234	5551234 + #0
2. ...to pulse dial 555-1234 followed by a Touch Tone 9	*6 5551234 *6 9 + #0
3. ...to dial a 9, a 4 second pause and then 555-1234	9 *7 5551234 + #0
4. ...to set the dialing speed to fast	*2
5. ...to enable unlimited user dialing after the phone has speed dialed	*4
6. ...to clear the speed dial number or disable speed dialing	#0

D. Touch Tone and Pulse Dial Speeds

The **K-1900** Series phone can be programmed to dial at normal or fast dialing speeds. Enter ***1** for normal dialing speed - 120ms on/off Touch Tones or 10 pps pulse dialing. Enter ***2** for fast dialing speed - 50ms on/off Touch Tones or 20 pps pulse dialing.

E. Security Code

A six digit security code is required to access the programming mode. The factory set security code is **845464** (V-I-K-I-N-G). It is recommended that you change the security code to a personal 6 digit number (0-9) and store in memory location **#9**. **Note:** The security code must be six digits in length and cannot contain a ***** or **#**.

F. Method Of Dialing

The **K-1900** Series phones are factory set to automatically dial using Touch Tones. A ***6** entered in the speed dial number will toggle the dialing mode between Touch Tone and pulse (see section **C**, example **2**).

Note: You can NOT program a ***** and **#** to be pulse dialed.

G. Touch Tone User Dialing Restriction (factory enabled)

The **K-1900** Series phones are designed to restrict fraudulent calls from hand held pocket dialers. After speed dialing, the **K-1900** Series phones will restrict (hang up) when they detect any Touch Tone that they did not generate. To restrict user dialing, enter ***3** while in programming. To enable user dialing, enter ***4** while in programming.

Adding an Internal Ringer

An optional **Q170600** internal ringer is available. For more information, retrieve **Fax Back Document 845**.

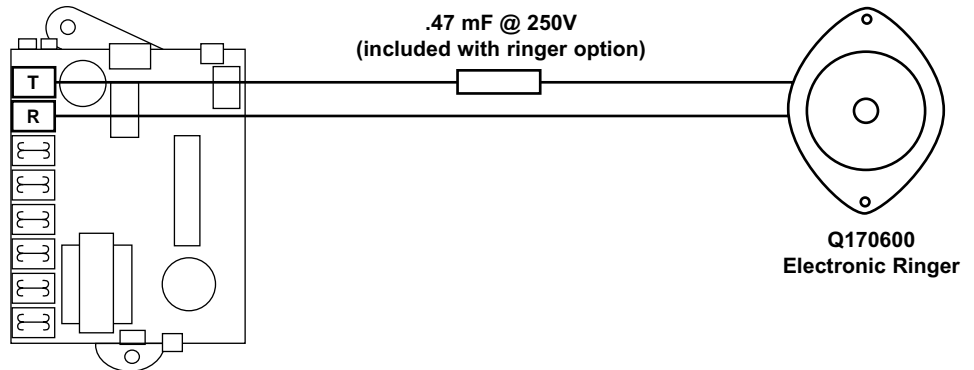

Related Products



VE-9x12 Weatherproof Enclosures

Install Your Viking Product in a Weatherproof Enclosure

The **VE-9x12** provides the ultimate in weather protection for your Viking product!

The enclosure is constructed of cast aluminum and is made for years of outdoor service. The heavy-duty aluminum door is labeled "Telephone" and has a gasket seal to keep out even the harshest weather. Choose between two panels that allow mounting many different Viking products. The **VE-9x12** is available in two high visibility colors: safety yellow or emergency red

For more information on the **VE-9x12**, retrieve **Fax Back Document 413**.

Vandal Resistant Hot-Line Panel Phone with Touch Tone Keypad

The **K-1900-8** Stainless Steel Panel Phone features a built-in Hot-Line dialer as well as a weather resistant keypad. The dialer can provide both Touch Tone dialing as well as 10/20 pps pulse dialing. After the phone number has been dialed, the Touch Tone keypad is enabled to permit additional manual dialing.

The **K-1900-8** housing consists of a heavy gauge, stainless steel panel, a metal Touch Tone keypad, an armored cable, and an all metal cradle for both weather and vandal resistance.

For more information on the **K-1900-8** Hot-Line Panel Phone, retrieve **Fax Back Document 312**. For more information on the **VE-Series** Surface Mount Boxes, retrieve **Fax Back Document 424**.

K-1900-8
Shown with VE-5x10



Product Support Line...715.386.8666

Fax Back Line...715.386.4345

Due to the dynamic nature of the product design, the information contained in this document is subject to change without notice. Viking Electronics, and its affiliates and/or subsidiaries assume no responsibility for errors and omissions contained in this information. Revisions of this document or new editions of it may be issued to incorporate such changes.