

# Uniden®

UNIDEN  
CORDLESS  
TELEPHONES



## DXI8560 Series

**At Uniden, we'll take care of you!**

Thank you for purchasing a Uniden product.

If you have any questions or problems,

**please do not return this product to the place of purchase.**

<b>Having Trouble?</b>	Our customer care specialists are here to help you! Visit our website at <a href="http://www.uniden.com">www.uniden.com</a> or call our Customer Hotline at <b>1-800-297-1023</b> during regular business hours.*
<b>Need a Part?</b>	To order headsets, additional handsets, replacement batteries or other accessories, visit our website at <a href="http://www.uniden.com">www.uniden.com</a> or call <b>1-800-554-3988</b> during regular business hours.*
<b>Help for our Special Needs Customers</b>	Uniden provides a customer service hotline for accessibility questions. If you have disability and need customer service assistance or if you have any questions about how Uniden's products can accommodate persons with disabilities, please call the accessibility voice/TTY line: <b>1-800-874-9314 (voice or TTY)</b> . Accessibility information can be found on our website, <a href="http://www.uniden.com">www.uniden.com</a> , under the "Accessibility" link. If your call is received outside of our business hours, leave us a message and we will call you back.

\* Central Standard Time. Detailed customer service hours are available at [www.uniden.com](http://www.uniden.com).



# 1) Installing the Phone







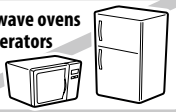
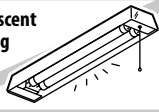

## 1-1. Choosing the Best Location

To get the best performance out of your new phone, put it in the best location:

### PLACE YOUR BASE

<p>Near an AC outlet and a telephone wall jack.</p> 	<p>In a centrally-located open area.</p> 
---	--

### TRY TO AVOID

<p>• Microwave ovens • Refrigerators</p> 	<p>• Fluorescent lighting</p> 	<p>• Other cordless telephones</p> 
<p>• TVs • Other electronics</p> 	<p>• Personal computers • Wireless LAN equipment</p> 	<p>• Areas with a lot of background noise</p> 
<p>• Direct sunlight • Extreme temperatures</p> 	<p>• Dust • Excessive moisture</p> 	<p>• Shock • Vibration</p> 

Notes: For maximum range

- Keep both the base and handset antennas free of obstruction.
- When the handset is not in use, place the handset in an upright position.
- Metal and reinforced concrete may affect cordless telephone performance.

## 1-2. Plug in the Battery

Use only the Uniden BT-905 rechargeable battery pack supplied with your phone.

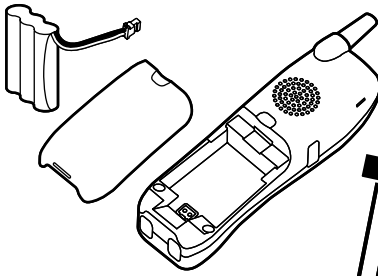
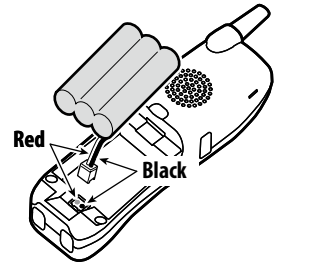
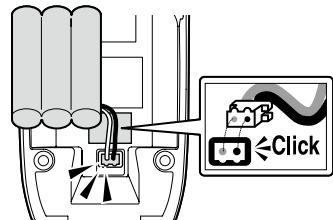
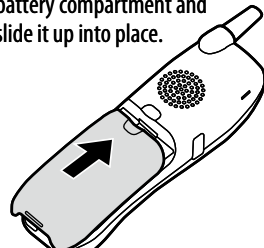
<p><b>1</b> Locate the battery packs, battery covers and the handsets.</p> 	<p><b>2</b> Line up the red and black wires on the battery pack connector with the sticker in the handset's battery compartment.</p>  <p>Red Black</p> <p>Push the battery connector in firmly. (You should hear it click into place.)</p>  <p>Click</p>
<p><b>3</b> Place the cover over the battery compartment and slide it up into place.</p> 	

## 1-3. Plug in the Base and Charging Cradle

You can put the charging cradles for additional handsets anywhere they can get power. They do not have to connect to a phone line.

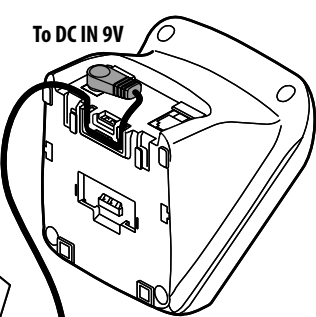
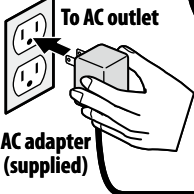
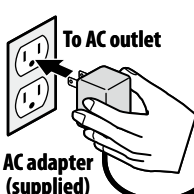
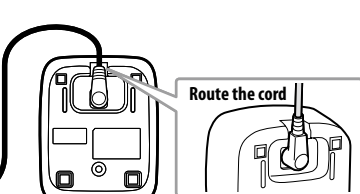
<p><b>4</b> Connect the base's AC adapter to the DC IN 9V jack.</p>	<p>To DC IN 9V</p> 
<p><b>5</b> Route the cord through the molded wiring channel.</p>	
<p><b>6</b> Connect the base's AC adapter to a standard 120V AC wall outlet. DO NOT use an AC outlet controlled by a wall switch.</p>	<p>To AC outlet</p>  <p>AC adapter (supplied)</p>
<p><b>7</b> Connect the charging cradle's AC adapter to a standard 120V AC wall outlet.</p>	<p>To AC outlet</p>  <p>AC adapter (supplied)</p> <p>Route the cord</p> 

Don't put any power cord where people might trip over it or step on it. If a power cord becomes chafed or worn out, it can create a fire or electrical hazard.

**8** Place one handset in the base and the other in the charging cradle.

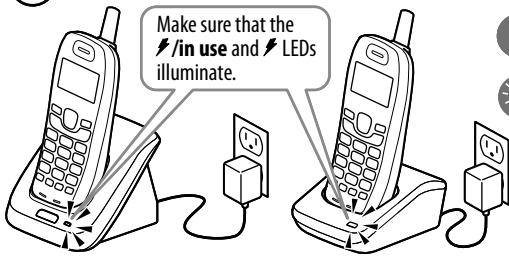

- ?** What if the charge LED doesn't light up?
- Check AC adapter connection.
  - Make sure you are not using an outlet that's controlled by a wall switch.

**Note:** For optimum battery life, charge all of your handsets completely before you connect the telephone cord. The first time you charge a new battery, allow 15 to 20 hours.

### 1-4. Connect the Telephone Cord

**9** Connect the telephone cord to the **TEL LINE** jack on the rear of the base.

**10** Connect the telephone cord to a telephone wall jack.

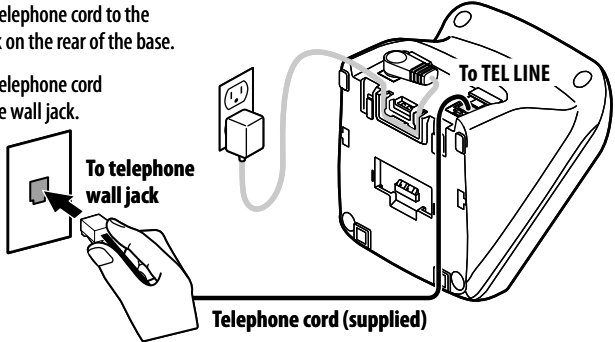

**Note:** If the telephone cord does not fit into your telephone wall jack, contact your local phone provider for assistance.

If you receive high-speed internet service through your telephone line (referred to as DSL), you should install a DSL filter between the telephone base and the wall jack. Standard telephones often can't operate correctly without a DSL filter.

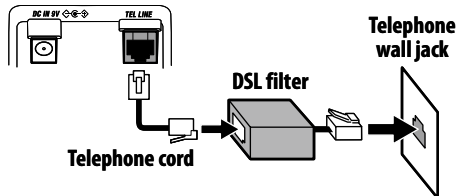

### Test the connection

**11** Pick up the handset from the base and press **[TALK/flash]**. You should hear a dial tone, and the display should show **TALK**.



- ?** What if I can't hear a dial tone?  
• Check the telephone cord connection on the base.
- ?** What if the display doesn't show **TALK**?  
• Put the handset back in the base for at least five seconds. Make sure the /in use LED flashes.

**12** Make a quick test call, and then press **[END]** to hang up.



- ?** What if the call doesn't go through?  
• Check to see if your telephone provider uses pulse dialing. (See section 3-1 on System Options.)
- ?** What if there is a lot of static?  
• Check the sources of interference described in section 1-1 on Choosing the best location: is the base near any of those?

### 1-5. Register the Accessory Handsets

**13** One by one, put each additional handset in the base. The /in use LED should flash as the base recognizes the handset.

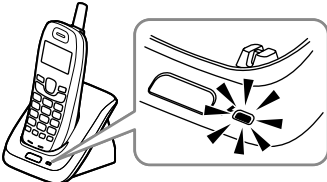

- ?** What if the /in use LED doesn't flash?  
• Pick the handset up and put it back in the base.

**14** Wait at least five seconds, then pick up the handset and press **[TALK/flash]**. Make sure you can get a dial tone on each handset.



### 1-6. Things to Remember

- When you charge the handsets, the Caller ID summary screen and the name of the handset appear in the display.
- Lots of people put **HANDSET #1** in the base, but it doesn't matter which handset you put in the base and which one you put in the charging cradle.

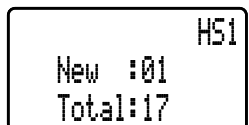

**Now your phone is ready to use!**

### 1-7. Attach the Belt Clip

#### To attach the belt clip

Insert the tabs on the side of the belt clip into the holes on either side of the handset. Press the belt clip down until it clicks into place. (Tug on the clip to make sure it's secure.)

#### To remove the belt clip

Gently pull the tabs out of the holes, then slide the belt clip off of the handset.

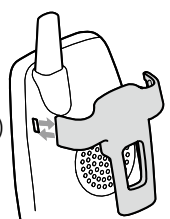

## 2) Getting to Know Your New Phone

### 2-1. A few Hints on the Manual

This manual uses several different type styles to help you distinguish between different parts of the phone:

- **Bold** text with “[ ]” indicates a key or button on the phone
- ALL CAPITALS indicates text on the display, such as menu options, prompts, and confirmation messages
- **lower case bold** text indicates a status light on the phone

#### Terms used in this manual

<b>Base</b>	The main part of the phone that connects to your phone line and lets you make and receive calls.
<b>Charging cradle</b>	A cradle that charges the handset battery. It connects to power but does not connect to a phone line.
<b>CID</b>	Caller ID is available from your telephone provider. With this service, you can see the name and number of incoming callers.
<b>CIDCW</b>	Caller ID on Call Waiting is available from your telephone provider. With this service, you can see incoming caller information while on another call.
<b>Handset</b>	A cordless handset that can be placed anywhere in your home or office where AC power is available.
<b>Standby</b>	The phone is not in use. (It doesn't matter whether the handset is in the cradle: the <b>[TALK/flash]</b> hasn't been pressed, and there is no dial tone.)
<b>Talk</b>	A dial tone has been enabled, so you can dial and carry on a conversation with an outside party.

Note: Illustrations in this manual are used for explanation purposes and may differ from the actual unit.

### 2-3. Parts of the Handset

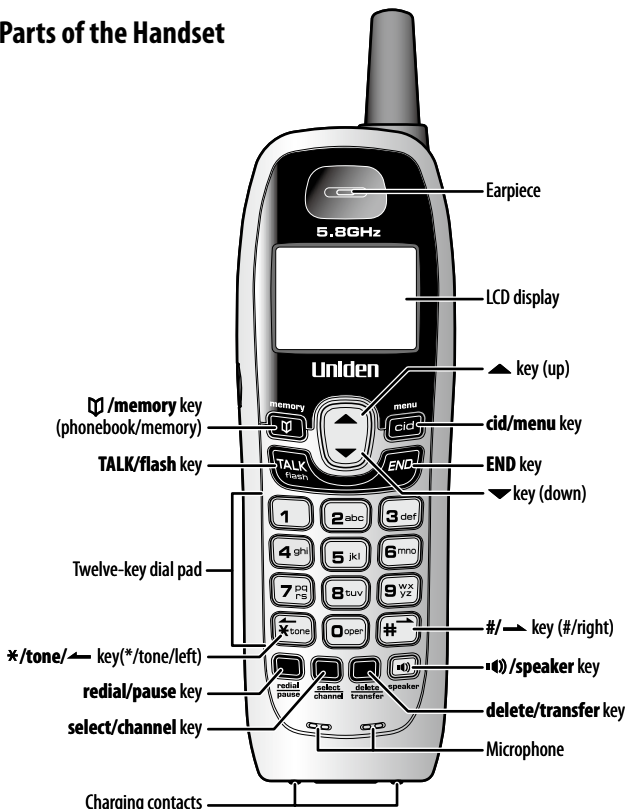

#### Using the handset menu

- To open the handset menu, press and hold **[cid/menu]** for two seconds.
- The arrow pointer on the left side of the line shows which menu item is currently highlighted. Use **[▲]** to move the pointer up and **[▼]** to move the pointer down.
- If the phone beeps and stays on the same line, it means you have reached the top or bottom of the list.
- Press **[select/channel]** to rotate through the available options for the highlighted menu item.
- Press **[END]** to exit the menu.

Note: You can find detailed information on the handset menu in section 3 on Setting Up Your Phone and section 4 on Using Your Phone.

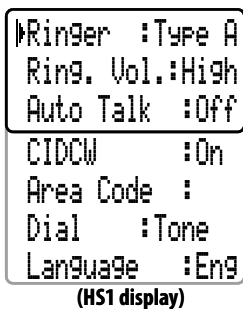

### 2-4. Parts of the Base

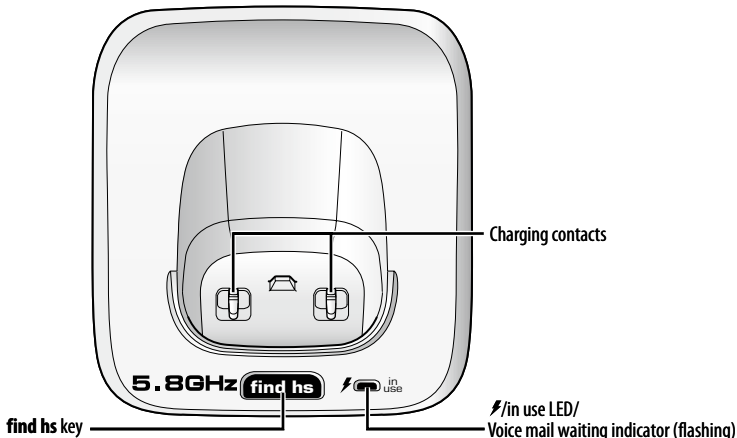

## 3) Setting Up Your Phone

Your phone has four basic options that you need to set up first. You should only have to set these options once, and you may not have to change any of them: Dial mode (tone or pulse dialing)

- Dial mode (tone or pulse dialing)
- CIDCW (Caller ID on Call Waiting)
- Language
- Auto talk

You might change two handset-specific options --ringer type and ringer volume -- more often, depending on the situation. There's another option, area code, that you should only set if you can use seven-digit dialing (see section 5-3 on Using Seven Digits Instead of Ten).

### 3-1. System Options (from HS1 only)

These options can only be changed from handset 1 (HS1). After changing these settings, you must put HS 1 back in the base cradle to activate them.

#### Changing from tone to pulse dialing (DIAL)

Your phone can communicate with the telephone network in two different ways: tone dialing or pulse dialing. These days, most phone networks use a method called tone dialing, so your phone comes programmed for tone dialing. If your phone company uses pulse dialing, you need to change your phone's dial settings. If you don't get a dial tone or can't connect to the telephone network, follow the steps below to modify your phone's settings:

- 1) Make sure you have Handset 1 (HS 1).
- 2) With the phone in standby, press and hold **[cid/menu]**.
- 3) Press **[▼]** to move the pointer to DIAL.
- 4) Press **[select/channel]** to set the phone to pulse dialing.
- 5) Press **[END]** and **put the handset back in the base**. Handset 1 communicates the new setting to the base, and the base activates the setting on any other handsets.

Note: If you use pulse dialing and you need to send DTMF tones during a call (if you're using an automated response system, for example), press **[\*/tone/←]** to temporarily switch to tone dialing. When the call ends, the phone automatically returns to pulse dialing mode.

#### Activating Caller ID on Call Waiting (CIDCW)

**You must subscribe to Caller ID service through your local telephone provider to use this feature.**

Caller ID allows you to see the name and number of the calling party before you answer the phone. Caller ID on Call Waiting (CIDCW) lets you see the name and number of a call that comes in when you are on the line.

- 1) Make sure you have Handset 1 (HS 1).
- 2) With the phone in standby, press and hold **[cid/menu]**.
- 3) Press **[▼]** to move the pointer to CIDCW.
- 4) Press **[select/channel]** to toggle and turn on Caller ID on Call Waiting.
- 5) Press **[END]** and **put the handset back in the base**. Handset 1 communicates the new setting to the base, and the base activates the setting on any other handsets.

### 3-2. Handset-specific Options

These options can be set differently on each handset. You can also set these options while another handset is using the phone.

#### Setting the display language (LANGUAGE)

The handset menus can use English (ENG, default), French (FR.) or Spanish (ESP).

- 1) With the phone in standby, press and hold **[cid/menu]**.
- 2) Press **[▼]** to move the pointer to LANGUAGE.
- 3) Press **[select/channel]** to select ENG, FR. or ESP.
- 4) When the display shows the language you want, use **[▲]** and **[▼]** to move the pointer to another menu item.

OR

If you're finished, press **[END]** to return the handset to standby.

#### Activating AutoTalk (AUTO TALK)

With Auto Talk, you can answer the phone just by picking up the handset from the cradle: you don't have to press any keys. If the handset is already off the cradle, Auto Talk also lets you answer by pressing any key on the twelve-key dial pad (instead of just **[TALK/flash]**).

- 1) With the phone in standby, press and hold **[cid/menu]**.
- 2) Press **[▼]** to move the pointer to AUTO TALK.
- 3) Press **[select/channel]** to turn Auto Talk on.
- 4) Use **[▲]** and **[▼]** to move the pointer to another menu item.

OR

If you're finished, press **[END]** to return the handset to standby.

#### Setting the ringer tone (RINGER)

You can set the ring tone separately for each handset.

- 1) With the phone in standby, press and hold **[cid/menu]**.
- 2) Press **[select/channel]** to rotate through the four available ring tones (A, B, C, and D). As you switch to the next ring tone, the handset sounds a sample of that ringer.
- 3) When you hear the ringer you want, use **[▲]** and **[▼]** to move the pointer to another menu item.

OR

If you're finished, press **[END]** to return the handset to standby.

The handset will use the new ring tone starting with the next incoming call.

#### Setting the handset ringer volume (RING.VOL.)

You can choose from three ringer volume settings separately for each handset. To turn the ringer off, select RINGER OFF.

- 1) With the phone in standby, press and hold **[cid/menu]**.
- 2) Press **[▼]** to move the pointer to RING VOL.
- 3) Press **[select/channel]** to rotate through the three available volume levels (HIGH, LOW, and OFF). As you switch to the next volume level, the handset sounds a sample of the current ring tone at that level.
- 4) When you hear the volume level you want, use **[▲]** and **[▼]** to move the pointer to another menu item.

OR

If you're finished, press **[END]** to return the handset to standby.

The handset will use the new ringer volume starting with the next incoming call.

Note: If you set the ring volume to OFF, this handset won't ring. The other handset(s) will ring according to their individual settings.

## 4) Using Your Phone

### 4-1. Making and Receiving Calls

	...from a handset	...from a handset speaker phone
<b>To make a call...</b>	<ol style="list-style-type: none"> <li>1) Pick up the handset.</li> <li>2) Press <b>[TALK/flash]</b>.</li> <li>3) Listen for the dial tone.</li> <li>4) Dial the number.</li> </ol> <p>OR</p> <ol style="list-style-type: none"> <li>1) Pick up the handset.</li> <li>2) Dial the number.</li> <li>3) Press <b>[TALK/flash]</b>.</li> </ol>	<ol style="list-style-type: none"> <li>1) Pick up the handset.</li> <li>2) Press <b>[☎]</b>.</li> <li>3) Listen for the dial tone.</li> <li>4) Dial the number.</li> </ol> <p>OR</p> <ol style="list-style-type: none"> <li>1) Pick up the handset.</li> <li>2) Dial the number.</li> <li>3) Press <b>[☎]</b>.</li> </ol>
<b>To answer a call...</b>	<ol style="list-style-type: none"> <li>1) Pick up the handset. (If AutoTalk is on, the phone automatically answers when you pick it up from the cradle.)</li> <li>2) Press <b>[TALK/flash]</b>. (If Auto Talk is on, you can also press any key on the twelve-key dial pad.)</li> </ol>	<ol style="list-style-type: none"> <li>1) Pick up the handset.</li> <li>2) Press <b>[☎]</b>.</li> </ol>
<b>To hang up...</b>	Press <b>[END]</b> or return the handset to the cradle.	

## 4-2. Switching a Call to the Handset Speakerphone

To switch a normal call to the speakerphone, press [ **☎** ] on the handset. To switch back to a normal call, press [ **☎** ] again.

## 4-3. Transferring a Call

You can transfer a call from one handset to another.

Note: Only one handset at a time can talk with an outside caller. While one handset is in use, other handsets cannot listen to conversations or make an outgoing call.

- 1) During a call, press **[delete/transfer]**. This places the call on hold.
- 2) Press the number key that matches the handset you want to page (1 for Handset 1, 2 for Handset 2, etc.) or press 0 to page all other handsets. (If you only have two handsets, the phone automatically pages the second handset for you.)
- 3) The handset display shows LINE ON HOLD along with the number of the handset you are paging. Both your handset and the paged handset sound a paging tone that is distinct from any of the available ringer tones.
- 4) If the other handset picks up the call, the paging tone stops, and your handset returns to standby.
  - To cancel the transfer and return to the caller, press **[delete/transfer]**, **[TALK/flash]** or [ **☎** ].
  - If no one picks up the transferred call within five minutes, the call will be disconnected.

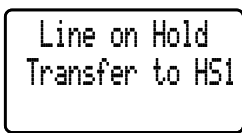

### To receive a transfer call

When a handset receives a transfer page, it sounds the distinct paging tone and shows CALL TRANSFERRED in the display. To answer a transferred call, pick up the handset and press **[TALK/flash]** or [ **☎** ]. (If Auto Talk is on, the phone automatically answers when you pick it up from the cradle; if the handset is already off the cradle, you can also press any key on the twelve-key dial pad.)

## 4-4. Redialing the Last Dialed Number

- 1) Pick up the handset from the cradle.
  - 2) Press **[redial/pause]**.
  - 3) Press **[TALK/flash]** or [ **☎** ].
- OR
- 1) Pick up the handset from the cradle.
  - 2) Press **[TALK/flash]** or [ **☎** ].
  - 3) Listen for the dial tone.
  - 4) Press **[redial/pause]**.

## 4-5. Adjusting the Speaker Volume

You can change the speaker volume on the handset earpiece, or the handset speakerphone. When you are on a normal call, press [ **▲** ] to make the earpiece louder or [ **▼** ] to make it softer. The handset display shows the current volume level for the earpiece.

When you are using the speakerphone, use [ **▲** ] or [ **▼** ] to change the speaker volume. The handset display shows the current volume level for the handset speakerphone.

There are four volume levels: LOW, MEDIUM, HIGH, and MAXIMUM.

- Notes:
- The handset earpiece and the handset speakerphone have separate volume settings.
  - If you hear three quick error beeps, it means the earpiece or speaker is already at the lowest (LOW) or highest (MAXIMUM) volume level.

## 4-6. Finding a Lost Handset

To locate a lost handset, press **[find hs]** on the base. All registered handsets will beep for sixty seconds. To cancel paging, press **[find hs]** again or press any key on the found handset.

## 4-7. Muting the Ringer

When the phone is ringing, you can mute the ringer on the handset. Muting stops the ringer for the current call only: the ringer will sound with the next incoming call. You can only mute the handset ringer if the handset is already off the cradle when the handset starts ringing. Press **[END]** to mute the incoming ring.

## 4-8. Voice Mail Waiting Indicator

If you subscribe to voice mail service through your local telephone company, you can use your cordless telephone to access your voice mailbox. The voice mail company will provide you with the access number. The **in use** LED on the base of your phone flashes whenever you have messages waiting in your voice mailbox.

### To access your voice mailbox

Just dial the access number supplied by your voice mail provider to enter your mailbox. You can program your voice mail access number to a speed dial number.

If the voice mail waiting indicator remains on after you have retrieved your messages, press and hold **[find hs]** for five seconds. This will reset the indicator.

## 4-9. Using an Optional Headset

- To install a headset, remove the headset jack cover and insert the headset plug into the headset jack.
- When you connect a headset, the earpiece and speakerphone are automatically muted. If you want to re-activate the earpiece or speakerphone, remove the headset plug.
- You will still make and receive calls as usual: just use your headset to talk to the caller once the call connects.
- You can purchase headsets from our website at [www.uniden.com](http://www.uniden.com) or by calling our Parts Department (See the back cover page).

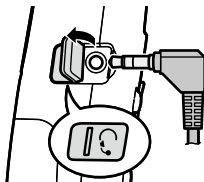

## 5 Using Caller ID and Call Waiting

If you subscribe to Caller ID from your phone company, your phone will show you the caller's phone number and name (if available) whenever a call comes in. If you subscribe to both Call Waiting and Caller ID, the phone also shows you the name and the number of any call that comes in while you're on the line.

The date and time received	5/11 12:30PM
Caller's name	Jane Smith
Caller's Phone Number	214-555-1234

Note: If you answer a call before the Caller ID record is received (for example, before the second ring), the Caller ID record will not appear.

The phone stores the Caller ID information for up to thirty incoming calls - even unanswered calls. If the phone receives more Caller ID records than it can store, the oldest record in the list is automatically deleted.

For information on storing Caller ID records in the phonebook, see section 6-6.

### 5-1. Reviewing the Caller ID Record List

You can review the Caller ID list when the handset is in standby or during a call.

- 1) Press **[cid/menu]**. The summary screen displays the total number of CID records along with the number of new CID records (that is, calls that you haven't reviewed yet).
- 2) Use [ **▼** ] to scroll through the records from the latest to the earliest, or use [ **▲** ] to scroll through the records from the earliest to the latest.
- 3) Press **[cid/menu]** to exit the Caller ID list.

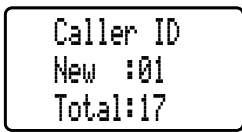

For new Caller ID records, the phone keeps a count of the number of calls received from the same caller (instead of saving the information multiple times). The Caller ID record shows the time and date of the most recent call from that number, and the number of calls appears next to the received time. The phone only maintains this count for new or “unviewed” records: once you review that record, the number is cleared.

12/30 11:59PM 01 Jane Smith 214-555-1234
--

## 5-2. Making a Call from the Caller ID List

- 1) With the phone in standby, press **[cid/menu]**.
- 2) Use **[▲]** or **[▼]** to find the Caller ID record you want to call.
- 3) If you need to add or delete a “1” from the displayed phone number, press **[1]**.

What’s this “add or delete a 1” about?

- Any phone number in the Caller ID records might (or might not!) have a “1” at the front, depending on how different phone companies send the Caller ID information.
- The phone dials the number exactly as it appears in the Caller ID record.
- If the phone number is a long distance or toll call, but the Caller ID record does not have a “1” in front of the number, press **[1]** to add it.
- If the phone number is a local or non-toll call, but the Caller ID record has a “1” in front of the number, press **[1]** to delete it.

- 4) Press **[TALK/flash]** or **[☎]** to dial the number.

Note: You can also press **[TALK/flash]** or **[☎]** before you access the Caller ID list. When you come to the phone number you want to dial, press **[select/channel]**.

## 5-3. Using Seven Digits Instead of Ten

If you can make a local call by dialing only seven digits instead of ten, you can tell the phone to hide your local area code in the Caller ID list; any calls from outside your area code will show all ten digits.

### Entering your area code

You can enter the area code in each handset separately (for example, if you want to hide the area code on one handset but not another):

- 1) With the phone in standby, press and hold **[cid/menu]**.
  - 2) Press **[▼]** to move the pointer to select AREA CODE. If an area code was already stored, the handset will display it.
  - 3) Press **[select/channel]** to edit the area code.
  - 4) Use the number keys (**[0] – [9]**) to enter all three digits of your area code.  
If you make a mistake, press **[delete/transfer]** to erase the last digit.
  - 5) When the number is correct, press **[select/channel]**. A confirmation tone sounds.
  - 6) Press **[END]**. The handset returns to standby.
- The phone uses the stored area code as a filter. When a call comes in, the phone compares the incoming area code to the code programmed in the handset. If the two codes match, the handset hides the area code in the Caller ID list.
  - When you’re in the Caller ID list, you can show the hidden area code by pressing **[3]**. Press **[3]** again to hide the area code.

When you dial from a Caller ID list or store a Caller ID record in the phonebook, the phone dials or stores the digits exactly as they appear on the display. If you need to use ten digits, be sure to press **[3]** to show the area code before you dial or store the number. See Section 6-6, Storing Caller ID Records in the Phonebook.

## 5-4. Deleting Caller ID Records

- Caller ID records are stored separately in each handset. Deleting a record from one handset will not delete the record from any other handsets.
- If you get an incoming call or page, the operation is canceled.

To delete one Caller ID record	To delete all the Caller ID records
<ol style="list-style-type: none"> <li>1) With the phone in standby, press <b>[cid/menu]</b>.</li> <li>2) Use <b>[▲]</b> or <b>[▼]</b> to find the Caller ID record you want to delete.</li> <li>3) Press <b>[delete/transfer]</b>. The display asks you to confirm.</li> <li>4) To delete the record, leave the pointer at YES. Or, if you changed your mind, press <b>[▼]</b> to move the pointer to NO.</li> <li>5) Press <b>[select/channel]</b> to confirm.</li> </ol>	<ol style="list-style-type: none"> <li>1) With the phone in standby, press <b>[cid/menu]</b>.</li> <li>2) From the CID summary screen, press <b>[delete/transfer]</b>. The display asks you to confirm.</li> <li>3) To delete all the records, use <b>[▲]</b> to move the pointer to YES. Or, if you changed your mind, leave the pointer at NO.</li> <li>4) Press <b>[select/channel]</b> to confirm.</li> </ol>

## 5-5. Using Call Waiting

If you subscribe to Call Waiting and a second call comes in when you are on the phone, the phone sounds a call waiting tone. If you also have Caller ID service, the phone shows the Caller ID information for the incoming call. (Only the handset that’s on a call when the call came in can see and store the Caller ID information.)

Talk 0:54 Jane Smith 214-555-1234
---

To put the original call on hold and switch to the waiting call, press **[TALK/flash]**. After a slight pause, you are connected to the new caller. Press **[TALK/flash]** again to switch back to the original caller.

OR

To hang up and answer the new call, press **[END]**. The phone disconnects the original caller and switches to the new caller.

## 6 Using the Phonebook (speed dial memory)

- If you enter phone numbers (along with names) into the handset’s phonebook/speed dial memory, you can dial them with just two key presses.
- Each handset can store ten different phonebook entries (corresponding to 0 through 9 on the number keypad); phonebook entries are separate for each handset.
- You can use the phonebook to store any number up to twenty digits. This is useful if you have a series of digits that you need to enter after your call connects, such as an access code or account number (See section 6-7 on Chain Dialing).
- When you’re editing the phonebook, you must press a key within thirty seconds or the phone will return to standby.

### 6-1. Entering a New Number into the Phonebook

- 1) With the phone in standby, press **[☎/memory]** to open the phonebook list.
- 2) Enter a number (**[0] – [9]**) or press **[▲]** or **[▼]** to find a phonebook entry that shows <EMPTY> beside it, and press **[select/channel]**. The handset opens the STORE NAME screen.
- 3) Use the letters above the number keys to enter a name for this phonebook entry. Press **[select/channel]** when you’re finished (or if you don’t want to enter a name). The handset opens the STORE NUMBER screen.

01 Jane Smith 02 <Empty> 03 <Empty>
---

Store Name
------------

## Entering text in your phone

The letters above the number appear in order: press the 2 key once for A, twice for B, and three times for C. You can also enter lower case letters and symbols (see the table below for all the available characters and what keys to press to enter them).

For example, to enter *Mom*

- 1) Press **[6]** once to enter *M*.
- 2) Press **[/>]** to move the cursor to the right.
- 3) Press **[6]** six times to enter *o*.
- 4) Press **[/>]** to move the cursor to the right.
- 5) Press **[6]** four times to enter *m*.

- New characters are inserted next to the character highlighted by the blinking cursor.

- To enter between characters, move the cursor and enter a new character.

- Use **[\*/tone/<]** and **[/>]** to move the cursor to the desired location.

- To enter two characters controlled by the same key, enter the first character, move the cursor to the right, then enter the second character.

- When the cursor is on the end of the digit, press **[delete/transfer]** to delete characters from last one as needed.

- If you made a mistake, move the cursor to the incorrect character and press **[delete/transfer]**. Then enter the correct character.

- To delete all the characters, press and hold **[delete/transfer]**.

	Number of times key is pressed								
keys	1	2	3	4	5	6	7	8	9
<b>1</b>	1								
<b>2 abc</b>	A	B	C	a	b	c	2		
<b>3 def</b>	D	E	F	d	e	f	3		
<b>4 ghi</b>	G	H	I	g	h	i	4		
<b>5 jkl</b>	J	K	L	j	k	l	5		
<b>6 mno</b>	M	N	O	m	n	o	6		
<b>7 pqrs</b>	P	Q	R	S	p	q	r	s	7
<b>8 tuv</b>	T	U	V	t	u	v	8		
<b>9 wxyz</b>	W	X	Y	Z	w	x	y	z	9
<b>0 oper</b>	*	#	-	&	(	)	(blank)	0	

- 4) Use the number keypad to enter the phone number. Press **[select/channel]** when you're finished. The handset sounds a confirmation tone and displays MEMORY STORED.

- The number can be up to twenty digits.

- If this phone number is a long distance call, be sure to include the "1" in front of the phone number.

- If you need the phone to wait before dialing the next digit (for example, to enter an extension number or access code), press **[redial/pause]** to insert a two-second pause between digits. The display shows a P where the phone will pause. You can add as many pauses as you want anywhere in the phone number, but each pause does count as a digit.

Store Number  
8007303456

- 5) After a few seconds, the handset goes back to the phonebook list. Use **[▲]** and **[▼]** to select another phonebook entry.

OR

Press **[t]/memory** to exit the phonebook. The phone returns to standby.

## 6-2. Finding Phonebook Entries

**If you know the number of the phonebook entry you're looking for:**

- Press and hold the number key (0 through 9) assigned to that phonebook entry.

The handset displays the name and phone number saved for that phonebook entry. If the entry has no number, the handset displays: <EMPTY> PRESS SELECT TO EDIT.

- If the number you picked wasn't the right phonebook entry, just use **[▲]** and **[▼]** to scroll through the phonebook entries. Stop scrolling when you see the phonebook entry you want.

**If you don't know the number of the phonebook entry you're looking for:**

- Press **[t]/memory** to open the phonebook list.

- Use **[▲]** and **[▼]** to scroll through the phonebook entries. Stop scrolling when you see the phonebook entry you want.

## 6-3. Making a Call from the Phonebook

With the phone in standby, find the phonebook entry you want to call (See section 6-2 on Finding Phonebook Entries). Then press **[TALK/flash]** or **[\*0]** to dial the number.

You can also press **[TALK/flash]** or **[\*0]** and then find the phonebook entry you want to call, and press **[select/channel]**.

## 6-4. Editing a Number in the Phonebook

- 1) With the handset in standby, find the phonebook entry you want to edit (See section 6-2 on Finding Phonebook Entries).
- 2) Press **[select/channel]** to open the MENU screen.
- 3) On the MENU screen, use **[▼]** to move the pointer to EDIT MEMORYXX, and press **[select/channel]**.
- 4) The handset takes you to the STORE NAME screen from Step 2 of section 6-1 on Entering a New Number into the Phonebook: just follow the same steps from there.

## 6-5. Deleting a Number from the Phonebook

- 1) With the handset in standby, find the phonebook entry you want to delete (See section 6-2 on Finding Phonebook Entries).
- 2) Press **[select/channel]** to open the MENU screen.
- 3) On the MENU screen, use **[▼]** to move the pointer to DELETE MEMORYXX, and press **[select/channel]**. The handset asks you to confirm.
- 4) To delete the entry, use **[▲]** to move the pointer to YES and press **[select/channel]**. The handset sounds a confirmation tone and goes back to the phonebook list.

OR

If you changed your mind, leave the pointer at NO and press **[select/channel]**. The handset goes back to the phonebook list.

## 6-6. Storing Caller ID Records in the Phonebook

- 1) With the phone in standby, press **[cid/menu]**.

- 2) Use **[▲]** or **[▼]** to find the Caller ID record you want to save.

Note: Remember, the phone stores the digits exactly as they appear on the display. If you need to add or delete a "1" from the displayed phone number, press **[1]**. (You can always go back and edit the phone number later.)

- 3) Press **[t]/memory** to open the phonebook.

- 4) Find the phonebook entry number you want to use (See section 6-2 on Finding Phonebook Entries).

- 5) Press **[select/channel]** to store the Caller ID information to the phonebook and return to the Caller ID list.

Note: If this number already has a phonebook entry saved to it, the handset asks if you want to replace the existing entry. Select YES to replace the existing entry with the new one, or select NO to cancel and keep the existing entry. The display returns to the Caller ID list.

## 6-7. Chain Dialing

If you often have to enter a series of digits or some type of code number during a call, you can save that code number to a phonebook entry. When your call connects, just use the phonebook speed dial to transmit the saved code number. (This is referred to as chain dialing.)



- 1) Enter the code number (up to twenty digits) into the phonebook (See section 6-1 on Entering a New Number into the Phonebook). Be sure to enter the code number into the phonebook exactly as you would enter it during a call.
- 2) During a call, when you hear the prompt that tells you to enter the code number, press **[Ⓜ/memory]** to open the phonebook.
- 3) Find the phonebook entry number you want to use (See section 6-2 on Finding Phonebook Entries).
- 4) Press **[select/channel]**. The phone sends the digits of the code number exactly as you saved them in the phonebook entry.

## 7) Mounting the Base on a Wall

You can mount the phone on any standard telephone jack wall plate.

**1** Route the AC adapter and the telephone cords through the hole of the wall mount bracket.

**2** Connect the AC adapter and the telephone cords as shown. Remember to route the AC adapter cord through the channel.

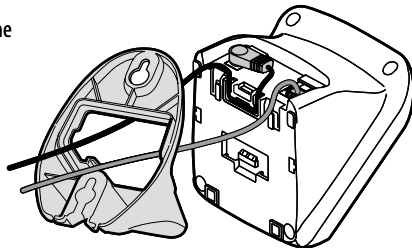

**3** Line up the four tabs on the wall mount bracket (two at the top and two at the bottom) with the four notches on the bottom of the base. Slide the bracket into place.

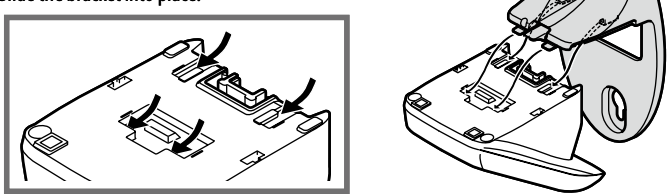

**4** Hook the AC adapter cord into the smaller notch at the bottom of the bracket, and let the cord hang below the bracket.

**5** Plug the telephone cord into the wall jack. Hook both sides of the telephone cord into the larger notch OR tuck the excess cord into the open space in the bracket.

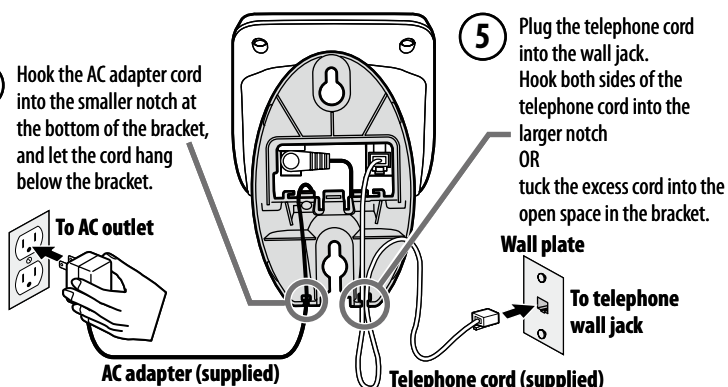

**6** Place the mounting slots over the pins on the wall plate.

**7** Slide the base down to lock it into place.

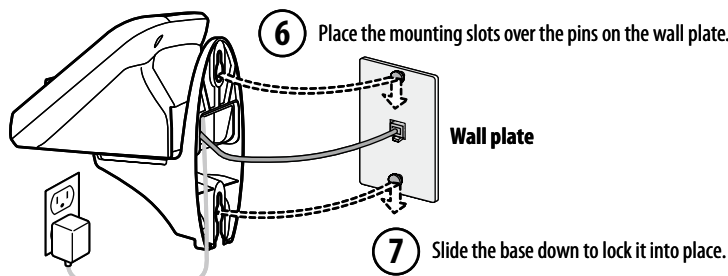

Note: To mount the phone directly on the wall, insert two 1 3/8 inch, #10 screws (not supplied) into the wall using anchors suitable for the wall material. Place the screws 3 15/16 inches apart, and allow 1/8 inch free space between the wall and screw heads.

### To remove the wall-mount bracket

At the bottom of the base, lift up on the release latch and push the bracket up.

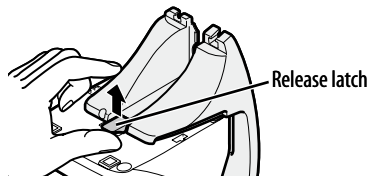

## 8) Troubleshooting and Maintenance

### 8-1. Solving Common Issues

If your phone is not performing to your expectations, please try these simple steps first. If these steps do not solve your problem, please call our Customer Hotline. See back cover page for contact information.

When you have this problem...	Try...
The <b>⚡/in use</b> LED or <b>⚡</b> LED won't turn on when the handset is placed in the cradle.	<ul style="list-style-type: none"> <li>• Checking the AC adapter connection.</li> <li>• Re-seating the handset in the cradle.</li> <li>• Cleaning the charging contacts on the handsets (See section 8-8).</li> </ul>
The audio sounds weak and/or scratchy.	<ul style="list-style-type: none"> <li>• Moving the handset closer to the base.</li> <li>• Moving the handset and/or base away from metal objects or appliances and try again.</li> <li>• Changing the channel by pressing <b>[select/channel]</b> during a call. This can help eliminate background noise.</li> </ul>
No handsets can make or receive calls.	<ul style="list-style-type: none"> <li>• Checking the telephone cord connection.</li> <li>• Disconnecting the AC adapter. Wait a few minutes, then reconnect it.</li> <li>• Asking your telephone company if they use pulse dialing (See section 3-1).</li> </ul>
A single handset can't make or receive calls.	<ul style="list-style-type: none"> <li>• Charging the battery for 15-20 hours.</li> <li>• Moving the handset closer to the base.</li> <li>• Changing the handset-to-base code (See section 8-3).</li> </ul>
A handset can make calls, but it doesn't ring.	<ul style="list-style-type: none"> <li>• Making sure the ringer isn't turned off (see section 3-2).</li> </ul>
A handset's display doesn't show anything.	<ul style="list-style-type: none"> <li>• Charging the battery for 15-20 hours.</li> <li>• Checking the battery pack connection.</li> </ul>

When you have this problem...	Try...
There's a lot of static during calls.	<ul style="list-style-type: none"> <li>Changing the channel by pressing <b>[select/channel]</b> during a call to help eliminate background noise.</li> <li>Keeping all handsets away from microwave ovens, computers, remote control toys, wireless microphones, alarm systems, intercoms, room monitors, fluorescent lights, and electrical appliances.</li> <li>Moving the base to a better location (see section 1-1).</li> </ul>
The handset won't display any Caller ID information.	<ul style="list-style-type: none"> <li>Letting incoming calls ring at least twice before answering.</li> <li>Checking to see if the call was placed through a switchboard.</li> <li>Checking with your telephone service provider to make sure your Caller ID service is active (See section 5).</li> </ul>
A handset is not working.	<ul style="list-style-type: none"> <li>Checking the battery pack connection.</li> <li>Charging the battery for 15-20 hours.</li> <li>Changing the handset-to-base code (See section 8-3).</li> </ul>
A handset says "Unavailable".	<ul style="list-style-type: none"> <li>Moving the handset closer to the base.</li> <li>Seeing if another handset is on a call or checking messages. (Two handsets can't communicate to the base at the same time.)</li> <li>Making sure the base is plugged in.</li> <li>Changing the handset-to-base code (See section 8-3).</li> </ul>
I can't transfer calls.	<ul style="list-style-type: none"> <li>Changing the handset-to-base code (See section 8-3).</li> </ul>
I can't get two handsets to talk to the caller.	<ul style="list-style-type: none"> <li>Only one handset at a time can talk with an outside caller. To allow the other handset to talk to the caller, transfer the call (See section 4-3).</li> </ul>
The Voice Message Waiting Indicator does not work.	<ul style="list-style-type: none"> <li>Contact your local telephone company to make sure that your telephone receives FSK message signaling.</li> <li>Reset the indicator by pressing and holding <b>[find hs]</b> for five seconds.</li> </ul>

## 8-2. Re-registering Handsets

When you first put your handsets into the base, they are registered to the base so they can communicate with the base. There may be some times when you have to re-register your handsets to the base:

- When you want to change the handset-to-base code.
- When there is a power failure that lasts more than one hour.
- If a handset's battery is completely discharged. (The handset must be recharged for 15 - 20 hours before re-registering to the base.)
- Any time you experience difficulty connecting to the base to make or receive calls.

To re-register handsets:

- Pick up the handset from the base. Press and hold **[find hs]** on the base.
- While holding **[find hs]**, place the handset in the base. The **⚡/in use** LED on the base begins to flash, indicating the base is registering the handset. Wait for at least five seconds.
- Pick up the handset from the base and press **[TALK/flash]**. If the display shows TALK, the handset is registered. If not, place the handset in the base to try again.
- Press **[END]**.
- One by one, place each handset in the base and wait for at least five seconds. (You don't need to hold **[find hs]** this time.) Repeat steps 3 - 4.

## 8-3. Changing the Handset-to-base Code

The handset-to-base code prevents other cordless devices from accidentally connecting to your base. If the battery pack is completely discharged or removed, the handset can "forget" the handset-to-base code, and the handset will not be able to communicate with the base.

If any one of handsets can't communicate with the base, place that handset in the base cradle to reset the code. Wait at least five seconds, then pick up the handset and press **[TALK/flash]**. If the display shows TALK, the code is reset.

If the code does not reset or if you suspect another cordless telephone might be using the same code (a rare situation), you can change the handset-to-base code completely. Re-register all handsets to the base following the instructions in section 8-2 on Re-registering Handsets above. Any handsets that are not properly re-registered may not be able to communicate with the base.

## 8-4. Traveling Out of Range

During a call, as you begin to move your handset too far from your base, noise increases. If you pass the range limits of the base, your call will terminate within one minute.

## 8-5. Liquid Damage

Moisture and liquid can damage your cordless phone.

- If the handset or base is exposed to moisture or liquid, but only the exterior plastic housing is affected, wipe off the liquid, and use as normal.
- If moisture or liquid has entered the plastic housing (i.e. liquid can be heard in the phone or liquid has entered the handset battery compartment or vent openings on the base), follow the steps below:

Handset	Base
1) Remove the battery cover and leave it off for ventilation.	1) Disconnect the AC adapter from the base, cutting off electrical power.
2) Disconnect the battery pack. Leave the battery cover off and the battery pack disconnected for at least three days.	2) Disconnect the telephone cord from the base.
3) Once the handset is completely dry, reconnect the battery pack and the battery cover.	3) Let dry for at least three days.
4) Recharge the handset's battery pack for 15 to 20 hours before using.	

### IMPORTANT:

You must unplug the telephone line while recharging the battery pack to avoid charge interruption.

### CAUTION!

DO NOT use a microwave oven to speed up the drying process. This will cause permanent damage to the handset, base and the microwave oven. After following these steps, if your cordless telephone does not work, please call our Customer Service Hotline. See back cover page for contact information.

## 8-6. Specifications

The phone complies with FCC Parts 15 and 68.

<b>Operating temperature</b>	0°C to +50°C (+32°F to +122°F)		
<b>AC Adapter</b>		<b>For the base</b>	<b>For the charging cradle</b>
	<b>Part number</b>	PS-0003	PS-0007
	<b>Input Voltage</b>	120V AC 60Hz	120V AC 60Hz
	<b>Output Voltage</b>	9V DC 350mA	9V DC 210mA
<b>Battery</b>	<b>Part number</b>	BT-905	
	<b>Capacity</b>	600mAh, 3.6V	
<b>Frequency</b>	921.103102 – 923.787761 MHz 5,856.533347 – 5,863.692437MHz		

Note: To avoid damage to the phone, use only Uniden PS-0003, PS-0007 and BT-905 with your phone. Specifications, features, and availability of optional accessories are all subject to change without prior notice.

## 8-7. Power Failure Operation

During the period that the power is off, you will not be able to make or receive calls with the telephone.

## 8-8. Battery Information

### Average battery life

With average use, your handset battery provides approximately six hours of talk time and approximately seven days of standby time. You can achieve optimum battery life and performance by returning the handset to the cradle after each use. When your handset is left off of the cradle, the battery will gradually discharge even if the handset is not being used. The actual talk time duration will be reduced in proportion to the amount of time the handset is off the cradle.

### Low battery alert

When the battery pack is very low and needs to be charged, the phone is programmed to eliminate functions in order to save power. If the phone is not in use, LOW BATTERY CHARGE HANDSET appears on the LCD, and none of the keys will operate. During a call, the handset beeps, and the LCD flashes LOW BATTERY. Complete your conversation as quickly as possible and return the handset to the cradle for charging.

Low Battery  
Charge Handset

Note: Information stored in the phone's memory will be retained for thirty minutes after the battery pack is removed. This includes all setup information, last number dialed, speed dial memory, and the CID list.

### Battery replacement and handling

When the operating time becomes short even after a battery is recharged, please replace the battery. With normal usage, your battery should last about one year. To order replacement batteries, please contact Uniden's Parts Department. The contact information is listed on the back cover page.

#### Warning:

To avoid the risk of personal injury or property damage from fire or electrical shock, only use the Uniden battery packs and power adapters specifically designated for this product.

#### Caution:

- Use only the specified Uniden battery pack (BT-905).
- Do not remove the battery from the handset to charge it.
- Never throw the battery into a fire, disassemble it, or heat it.
- Do not remove or damage the battery casing.

### Cleaning the charging contacts

To maintain a good charge, clean the charging contacts on the handset once a month. Dampen a cloth with plain water. Gently rub the damp cloth over the charging contacts until all visible dirt is removed. Dry the contacts thoroughly before returning the handset to the cradle.

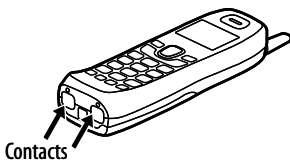

#### Caution:

Do not use paint thinner, alcohol, or other chemical products. Doing so may discolor the surface of the telephone and damage the finish.

## 9) Legal and Warranty Information

### 9-1. Precautions!

Before you read anything else, please note the following:

#### Warning!

**Uniden America Corporation DOES NOT represent this unit to be waterproof. To reduce the risk of fire, electrical shock, or damage to the unit, DO NOT expose this unit to rain or moisture.**

### 9-2. Rechargeable Nickel-Cadmium Battery Information

This equipment contains a rechargeable nickel-cadmium battery.

- Cadmium is a chemical known to the State of California to cause cancer.
- The rechargeable nickel-cadmium battery contained in this equipment may explode if disposed of in a fire.
- Do not short-circuit the battery.
- Do not charge the rechargeable nickel-cadmium battery used in this equipment in any charger other than the one designed to charge this battery as specified in the owner's manual. Using another charger may damage the battery or cause the battery to explode.
- Rechargeable Nickel-Cadmium Batteries Must Be Recycled or Disposed of Properly
- As part of our commitment to protecting our environment and conserving natural resources, Uniden voluntarily participates in an RBRC® industry program to collect and recycle used Ni-Cd batteries within the United States. Please call 1-800-8-BATTERY for information on Ni-Cd battery recycling in your area. (RBRC® is a registered trademark of the Rechargeable Battery Recycling Corporation.)



### 9-3. Lead Content Information

#### Warning!

**The cords on this product and/or accessories contain lead, a chemical known to the State of California to cause birth defects or other reproductive harm. Wash hands after handling.**

Uniden works to reduce lead content in our PVC coated cords in our products and accessories.

### 9-4. Important Safety Instructions

When using your telephone equipment, basic safety precautions should always be followed to reduce the risk of fire, electric shock and injury to persons, including the following:

1. Do not use this product near water, for example, near a bath tub, wash bowl, kitchen sink or laundry tub, in a wet basement or near a swimming pool.
2. Avoid using a telephone (other than a cordless type) during an electrical storm. There may be a remote risk of electric shock from lightning.
3. Do not use the telephone to report a gas leak in the vicinity of the leak.
4. Use only the power cord and batteries indicated in this manual. Do not dispose of batteries in a fire. They may explode. Check with local authorities for possible battery disposal instructions.
5. Do not disassemble any component of this product.

#### SAVE THESE INSTRUCTIONS

#### CAUTION!

Risk of explosion if battery is replaced by an incorrect type. Dispose of used batteries according to the instructions. Do not open or mutilate the battery, and disconnect the battery before shipping this product.

### 9-5. The FCC Wants You To Know

This equipment complies with Part 68 of the FCC rules and the requirements adopted by the ACTA.

On the bottom of this equipment is a label that contains, among other information, a product identifier in the format US: AAAEQ##TXXXX. If requested, this number must be provided to the telephone company.

An applicable Universal Service Order Codes (USOC) certification for the jacks used in this equipment is provided (i.e., RJ11C) in the packaging with each piece of approved terminal equipment. A plug and jack used to connect this equipment to the premises wiring and telephone network must comply with the applicable FCC Part 68 rules and requirements adopted by the ACTA.

A compliant telephone cord and modular plug is provided with this product. It is designed to be connected to a compatible modular jack that is also compliant. See installation instructions for details.

The REN is used to determine the number of devices that may be connected to a telephone line. Excessive RENs on a telephone line may result in the devices not ringing in response to an incoming call. In most but not all areas, the sum of RENs should not exceed five (5.0). To be certain of the number of devices that may be connected to a line, as determined by the total RENs, contact the telephone provider. For products approved after July 23, 2001, the REN for this product is part of the product identifier that has the format US:AAEQ##TXXXX. The digits represented by ## are the REN without a decimal point (e.g., 03 is a REN of 0.3). For earlier products, the REN is separately shown on the label.

If this equipment causes harm to the telephone network, the telephone company will notify you in advance that temporary discontinuance of service may be required. But if advance notice isn't practical, the telephone company will notify the customer as soon as possible. Also, you will be advised of your right to file a complaint with the FCC if you believe it is necessary. The telephone company may make changes in its facilities, equipment, operations or procedures that could affect the operation of the equipment. If this happens the telephone company will provide advance notice in order for you to make necessary modifications to maintain uninterrupted service. Please follow instructions for repairing, if any (e.g. battery replacement section); otherwise do not substitute or repair any parts of the device except as specified in this manual. Connection to party line service is subject to state tariffs. Contact the state public utility commission, public service commission or corporation commission for information. This equipment is hearing aid compatible.

Should you experience trouble with this equipment, please contact Uniden customer service at 800-297-1023. If the equipment is causing harm to the telephone network, the telephone company may request that you disconnect the equipment until the problem is resolved.

**NOTICE:** According to telephone company reports, AC electrical surges, typically resulting from lightning strikes, are very destructive to telephone equipment connected to AC power sources. To minimize damage from these types of surges, a surge arrester is recommended.

Changes or modifications to this product not expressly approved by Uniden, or operation of this product in any way other than as detailed by the owner's manual, could void your authority to operate this product.

This device complies with part 15 of the FCC rules. Operation is subject to the following two conditions: (1) This device may not cause harmful interference, and (2) This device must accept any interference received, including interference that may cause undesired operation. Privacy of communications may not be ensured when using this phone.

## Cordless telephone privacy

Cordless telephones are radio devices. Communications between the handset and base of your cordless telephone are accomplished by means of radio waves which are broadcast over the open airways. Because of the inherent physical properties of radio waves, your communications can be received by radio receiving devices other than your own cordless telephone unit. Consequently, any communications using your cordless telephone may not be private.

## 9-6. I.C. Notice

### Terminal equipment

**NOTICE:** This equipment meets the applicable Industry Canada Terminal Equipment Technical Specifications. This is confirmed by the registration number. The abbreviation, IC, before the registration number signifies that registration was performed based on a Declaration of Conformity indicating that Industry Canada technical specifications were met. It does not imply that Industry Canada approved the equipment.

**NOTICE:** The Ringer Equivalence Number (REN) for this terminal equipment is marked on the equipment itself. The REN assigned to each terminal equipment provides an indication of the maximum number of terminals allowed to be connected to a telephone interface. The termination on an interface may consist of any combination of devices subject only to the requirement that the sum of the Ringer Equivalence Numbers of all the devices does not exceed five.

### Radio equipment

The term "IC:" before the radio certification number only signifies that Industry Canada technical specifications were met. Operation is subject to the following two conditions: (1) this device may not cause interference, and (2) this device must accept any interference, including interference that may cause undesired operation of the device. "Privacy of communications may not be ensured when using this telephone".

## 9-7. One Year Limited Warranty

Important: Evidence of original purchase is required for warranty service. WARRANTOR: UNIDEN AMERICA CORPORATION ("Uniden") ELEMENTS OF WARRANTY: Uniden warrants, for one year, to the original retail owner, this Uniden Product to be free from defects in materials and craftsmanship with only the limitations or exclusions set out below.

WARRANTY DURATION: This warranty to the original user shall terminate and be of no further effect 12 months after the date of original retail sale. The warranty is invalid if the Product is (A) damaged or not maintained as reasonable or necessary, (B) modified, altered, or used as part of any conversion kits, subassemblies, or any configurations not sold by Uniden, (C) improperly installed, (D) serviced or repaired by someone other than an authorized Uniden service center for a defect or malfunction covered by this warranty, (E) used in any conjunction with equipment or parts or as part of any system not manufactured by Uniden, or (F) installed or programmed by anyone other than as detailed by the owner's manual for this product.

STATEMENT OF REMEDY: In the event that the product does not conform to this warranty at any time while this warranty is in effect, warrantor will either, at its option, repair or replace the defective unit and return it to you without charge for parts, service, or any other cost (except shipping and handling) incurred by warrantor or its representatives in connection with the performance of this warranty. Warrantor, at its option, may replace the unit with a new or refurbished unit. THE LIMITED WARRANTY SET FORTH ABOVE IS THE SOLE AND

ENTIRE WARRANTY PERTAINING TO THE PRODUCT AND IS IN LIEU OF AND EXCLUDES ALL OTHER WARRANTIES OF ANY NATURE WHATSOEVER, WHETHER EXPRESS, IMPLIED OR ARISING BY OPERATION OF LAW, INCLUDING, BUT NOT LIMITED TO ANY IMPLIED WARRANTIES OF MERCHANTABILITY OR FITNESS FOR A PARTICULAR PURPOSE. THIS WARRANTY DOES NOT COVER OR PROVIDE FOR THE REIMBURSEMENT OR PAYMENT OF INCIDENTAL OR CONSEQUENTIAL DAMAGES. Some states do not allow this exclusion or limitation of incidental or consequential damages so the above limitation or exclusion may not apply to you.

LEGAL REMEDIES: This warranty gives you specific legal rights, and you may also have other rights which vary from state to state. This warranty is void outside the United States of America and Canada. PROCEDURE FOR OBTAINING PERFORMANCE OF WARRANTY: If, after following the instructions in the owner's manual you are certain that the Product is defective, pack the Product carefully (preferably in its original packaging). Disconnect the battery from the Product and separately secure the battery in its own separate packaging within the shipping carton. The Product should include all parts and accessories originally packaged with the Product. Include evidence of original purchase and a note describing the defect that has caused you to return it. The Product should be shipped freight prepaid, by traceable means, to warrantor at:

Uniden America Service  
4700 Amon Carter Blvd.  
Fort Worth, TX 76155

May be covered under one or more of the following U.S. patents:

4,797,916	5,426,690	5,491,745	5,493,605	5,533,010	5,574,727	5,581,598	5,650,790	5,660,269	5,663,981	5,671,248
5,717,312	5,732,355	5,754,407	5,758,289	5,768,345	5,787,356	5,794,152	5,801,466	5,825,161	5,864,619	5,893,034
5,912,968	5,915,227	5,929,598	5,930,720	5,960,358	5,987,330	6,044,281	6,070,082	6,076,052	6,125,277	6,253,088
6,314,278	6,321,068	6,418,209	6,618,015	6,671,315	6,714,630	6,782,098	6,788,920	6,788,953	6,839,550	6,889,184
6,901,271	6,907,094	6,914,940	6,940,867	6,953,118	7,023,176	7,030,819	7,146,160	7,203,307	7,206,403	

Other patents pending.

Uniden® is a registered trademark of Uniden America Corporation.



As an Energy Star® Partner, Uniden has determined that this product or product models meets the Energy Star® guidelines for energy efficiency. Energy Star® is a U.S. registered mark.

