



SNC-DF80N/SNC-DF80P
SNC-DF50N/SNC-DF50P
Network Mini-dome Cameras

www.sony.com/security



Stunning video and audio brought to you by the IPELA series of visual communication products that encompass the three-pronged concept of Reality, Intelligence, and Usability. IPELA is the identity symbolizing the Sony vision for the workplace of the future, connecting people, places, and information with reality that has never before been achieved. IPELA products let you share, understand, and experience as if you are actually there, when in fact, you are miles away. It allows you to quickly grasp a situation to make better business decisions.

Reality

- High Frame Rate
- Dynamic Frame Intergration

Intelligence

- Intelligent Motion Detection
- Intelligent Object Detection

Usability

- JPEG, MPEG-4, H.264 Compression Formats
- Dual Encoding Capability
- User-Friendly GUI

Real audiovisual communication over networks – this is business communication of the future, this is business communication brought to you today, this is “IPELA”.

Reproducing Extremely Clear and Detailed Images, Sony Intelligent Mini-dome Cameras Provide a High Level of Security – Anytime, Anywhere

Sony introduces powerful new additions to its network mini-dome camera lineup, the SNC-DF80 and SNC-DF50, both of which support Intelligent Video Analytics.*¹ This efficient and intelligent processing method based on the Sony DEPA™ platform can provide great operational efficiency and a high level of security. The SNC-DF80 and SNC-DF50 incorporate advanced compression technologies to transmit image data in three different formats: JPEG, MPEG-4, and H.264. These cameras also employ robust detection methods – Intelligent Motion Detection (IMD) and Intelligent Object Detection (IOD) – to maximize the efficiency of the monitoring system. For easy setup, these cameras incorporate the Sony patented Ball-Joint Lens Mount mechanism, which provides quick and easy adjustment of the camera’s viewing angle during installation. The SNC-DF80 camera is designed to be used both indoors and outdoors and features a vandal- and weather-resistant*² body. It incorporates an advanced 1/3-type CCD with SuperExwave™ technology that offers extremely high sensitivity levels and delivers exceptionally clear images. The camera is also designed for 24x7 operation thanks to its Day/Night function, which can produce detailed images even in zero lx*³ lighting conditions.

The SNC-DF50 camera is compact in size, employs a highly sensitive imager, and incorporates unique Sony DynaView™ technology to reproduce images with wide dynamic ranges, making it ideal for use in extremely high-contrast environments.

With other useful features such as a Voice Alert function, Date/Time Superimposition, and Privacy Zone Masking, these Sony intelligent mini-dome cameras are ideal for a wide variety of surveillance and monitoring applications.

*¹ Intelligent video analytics is available when these cameras are used in conjunction with the Sony Network Recorder NSR Series Ver. 4.0 or higher, the Sony Intelligent Monitoring Software IMZ-RS400 Series Ver. 4.0 or higher, or third-party hardware and software designed to operate with these cameras to perform video analytics.

*² An optional YT-HU75 Heater Unit is required when the camera is used in temperatures less than -13 °F (-10 °C).

*³ Zero lx means the absence of visible light to the naked eye. IR illuminators are required to operate at zero lx.

Features

The DEPA Platform – Intelligent Video Analytics



The SNC-DF80 and SNC-DF50 cameras offer intelligent video analytics, based on the Sony DEPA platform. This comprises two elements: intelligent built-in camera functions, such as IMD and IOD, and rules/filters that determine which images should be recorded or when an alarm should be triggered.

When the network cameras perform IMD or IOD, 'tagged' objects and their associated metadata, including object position data, are sent either to the NSR Series recorder or the IMZ-RS400 Series software. These products then use the metadata, together with filters, to analyze object movement and to perform a predefined action, such as image recording or alarm triggering. This method of distributed processing minimizes server workload, network bandwidth, and storage requirements.

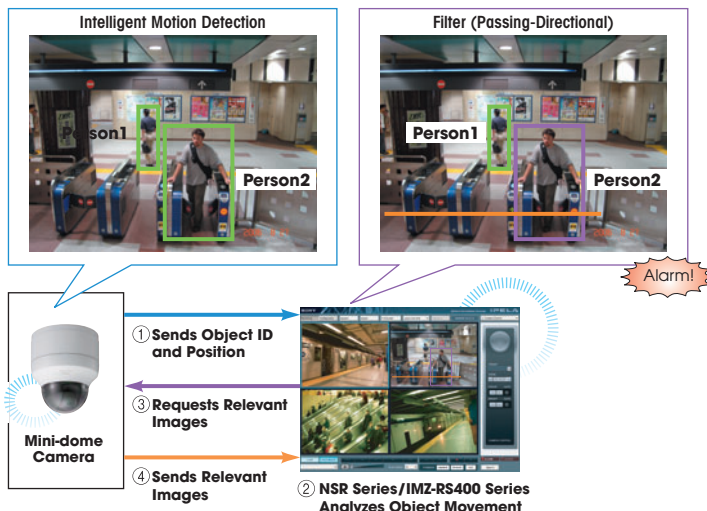

Distributed Enhanced Processing Architecture (DEPA)

High-quality Images

SuperExwave Technology SNC-DF80

The SNC-DF80 incorporates an advanced 1/3-type CCD with SuperExwave technology that achieves extremely high sensitivity levels. The camera provides a minimum illumination of 0.6 lx in color and 0.06 lx in B/W at F1.3, allowing it to capture clear and detailed images even under low light conditions. The high-quality CCD imager, in combination with the camera's state-of-the-art DSP technology, produces a high horizontal resolution of 540 TV lines via the analog composite video output, which provides amazingly clear and detailed images.



Image Comparison Between SNC-DF80 Camera and a Conventional Camera

Wide Dynamic Range With DynaView Technology SNC-DF50

The SNC-DF50 incorporates DynaView technology, which dramatically improves camera dynamic range by 128 times when compared to conventional cameras. This results in clear image reproduction, even in extreme high-contrast environments. The camera captures the same image twice – first with a normal shutter speed, and then with a high shutter speed. The dark areas captured at normal shutter speed and the bright areas captured at high shutter speed are then combined into one image using an advanced DSP LSI. Additionally, as these high-contrast scenes may have different lighting conditions, two white balance circuits are employed – one for normal shutter speed and the other for high shutter speed. This advanced technique reproduces high-contrast images with proper color.



DynaView Technology



Dynamic Frame Integration

These cameras incorporate Dynamic Frame Integration (DFI) technology to reproduce clear images that contain both still and moving objects. DFI technology detects movement within the image and reproduces those areas with minimal blurring, while areas with little or no movement are displayed naturally with minimal jagged edges. This unique algorithm also takes advantage of the interlaced-scan CCD, which is inherently more sensitive than progressive-scan CCDs and can provide clear images even in low light conditions.



SNC-DF80/DF50
Camera Image



Conventional
Camera Image

Image Comparison Between SNC-DF80/DF50
Camera and a Conventional Camera

JPEG Picture Quality Settings With Constant Bitrate Algorithm

Users can preset the JPEG picture quality for these cameras from a choice of ten levels. In addition, because these cameras incorporate a constant bitrate algorithm, they can limit the data bitrate while still maintaining high-quality images. This is useful for calculating the required storage capacity and bandwidth during installation.

Flexible and Easy Installation

Wall- or Ceiling-mountable/Easy Viewing-angle Adjustment

Both the SNC-DF80 and SNC-DF50 can be easily wall- or ceiling-mounted.⁴ Furthermore, because they are equipped with an analog composite output (RCA jack), the camera image can be monitored locally while the viewing angle is adjusted during installation. This makes focus and viewing-angle adjustment both accurate and easy.

⁴ Supplied bracket is required when the SNC-DF80 is wall- or ceiling-mounted.



Ceiling Surface Mount
(SNC-DF50)



Ceiling Flush Mount
(SNC-DF50/YT-ICB45 Ceiling
Mount Bracket)

Powerful 3.6x Zoom, Vari-focal Lens

These cameras come equipped with a 3.6x zoom, vari-focal lens that covers an extremely wide range of viewing angles from 100.8° (wide-angle) to 27.2° (telephoto). This feature provides great installation flexibility for a number of different applications and locations.

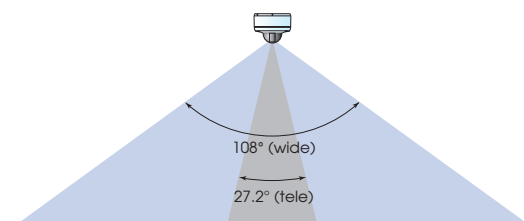

Ball-Joint Lens Mount Technology

With the Sony patented Ball-Joint Lens Mount mechanism incorporated into the vari-focal lens of these cameras, the lens can be rotated freely in any direction. Unlike conventional cameras, it takes only one action to adjust the pan and tilt angles, allowing for quick and easy adjustment of the camera's viewing angle during installation.



Sony Patented Ball-Joint Lens Mount

Ruggedized Design SNC-DF80

The vandal-resistant SNC-DF80 camera is housed in a heavy-duty, aluminum die-cast enclosure with an impact-resistant polycarbonate dome. It complies with the IP66⁵ standard, and offers additional water resistance by using a special inner conduit for the camera cables. For cold-weather outdoor applications, the optional YT-HU75 Heater Unit is available. This allows the camera to be used in severe temperatures as low as -40 °F (-40 °C).

⁵ Ingress Protection (IP) standard is a system for numerically classifying the degree of protection provided by enclosures of electrical equipment against solid objects and liquids. IP66 means there is no ingress of dust and the equipment is protected against powerful water jets.

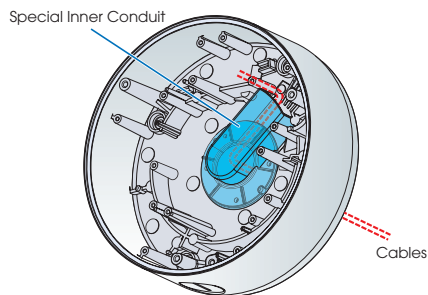

Water-resistant Design (SNC-DF80 inside)

Operational Flexibility

Selectable JPEG, MPEG-4, H.264 Compression Formats

These multi-codec cameras support three compression formats: JPEG, MPEG-4, and H.264. The industry-standard JPEG compression format is the best choice for high-quality still images. MPEG-4 provides clear moving images efficiently over networks when bandwidth is limited. And H.264 provides twice the efficiency of MPEG-4, for when bandwidth is even more limited.

Dual-encoding Capability

With a dual-encoding capability, these cameras can generate both MPEG-4 and JPEG images simultaneously. For example, the system can be set up to transfer MPEG-4 images over a WAN or an Internet VPN where network bandwidth is limited, while storing high-resolution JPEG images on a server that's configured on your LAN.

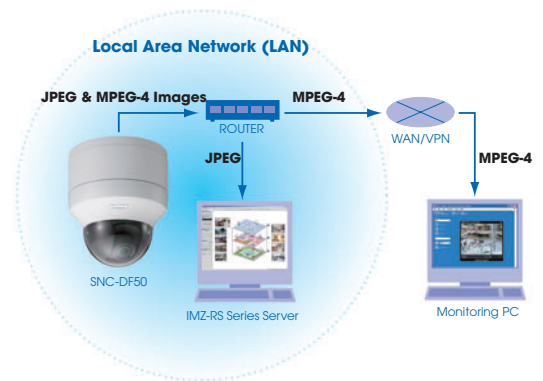

Dual Image Encoding

Day/Night Function SNC-DF80

The SNC-DF80 camera can switch from day mode (color) to night mode (B/W) by replacing its infrared-cut filter with a clear filter. Users can toggle between the two modes in different ways, either manually, on a predefined schedule, using an external sensor, or automatically in response to the scene illumination. When the camera is in night mode, it is sensitive to near-IR illuminators, allowing it to operate even in zero lx⁶ conditions.

⁶ Zero lx means the absence of visible light to the naked eye. IR illuminators are required to operate at zero lx.



Bi-directional Audio

Users can connect an external microphone to these cameras in order to pick up audio from a preferred location. They are also equipped with an active speaker output, enabling users to sound an alert or make an announcement from the camera unit via a remote location. This significantly expands the possibilities of monitoring applications.

Voice Alert

The Voice Alert function allows users to upload up to three pre-recorded audio files to the camera. These can then be played out via a locally connected speaker upon an alarm trigger.

High Level of Security

Intelligent Motion Detection

The built-in IMD function of these cameras can trigger a variety of actions, such as the storage and transfer of images or the activation of an external device through its output relays. False alarms caused by noise and repeated motion patterns are minimized thanks to an advanced Sony algorithm. Plus, when used in conjunction with DEPA-enabled recorders or software, a multitude of filter functions are available. These allow you to initiate alarms based on more specific movements, such as passing a virtual borderline or appearing into a virtual area.

Intelligent Object Detection^{*7}

The SNC-DF80 and SNC-DF50 cameras can detect objects that have been abandoned or become stationary for a specified duration within up to four designated detection areas. This feature is useful for detecting suspicious objects left in public places, or for detecting stalled cars or accidents on the road. As with IMD, filters can be used to refine this intelligence if the camera is configured with DEPA-enabled products.

^{*7} The intelligent object detection function and the intelligent motion detection function cannot be used simultaneously.

Sensor IN/Alarm OUT Ports

Equipped with a sensor input, these cameras can receive triggers from an external sensor. Also, two alarm relay outputs can be used to trigger external devices to perform a variety of actions.

Pre-/Post-alarm Image Storage

These cameras are capable of storing both pre- and post-alarm images on 16 MB of built-in memory or on removable storage media.^{*8}

^{*8} Storage on removable media is available with the SNC-DF80 only.

Network Security Features

IEEE802.1X Compliant

Both the SNC-DF80 and SNC-DF50 support IEEE802.1X port-based network access control. This means they can be integrated to a network environment that uses the IEEE802.1X client-authorization protocol for security purposes.

Versatile Interfaces

Analog Composite Video Output

These cameras can output an analog composite video signal via the BNC connector. This feature is ideal for outputting images to a local recording device or monitor.

Other Convenient Features

Date/Time Superimposition

The date and time of images recorded by these cameras can be superimposed on the video while it is being monitored and recorded. This feature is ideal for easily identifying the exact date and time of an event during playback. Also because the information becomes part of the video image, it is a useful feature when providing video evidence to authorities.

File Export to Removable Media SNC-DF80

The SNC-DF80 camera is equipped with a Compact Flash™ (CF) card slot, allowing users to export images on CF media as required.



CF Card Slot

Privacy Zone Masking^{*9}

These cameras can mask up to seven unwanted or prohibited areas within an image for privacy protection.

^{*9} Supplied "SNC Privacy Masking Tool" software is required to set masking areas.

24 V AC, 12 V DC, or PoE Operation

These cameras offer a choice of three types of power: 24 V AC, 12 V DC, or PoE (Power-over-Ethernet, IEEE 802.3af). They automatically adapt to whichever power source is used, making installation fast and effective.

Network Features of These Cameras

- Simultaneous Access for up to 20 Users
- Multicasting Capability



System Configurations

Stand-alone Configuration

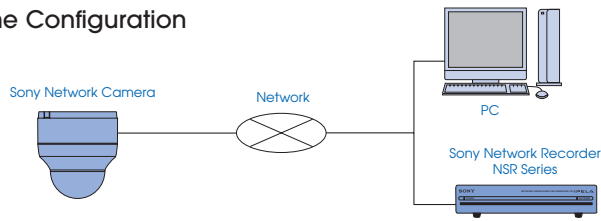

Client-server Configuration

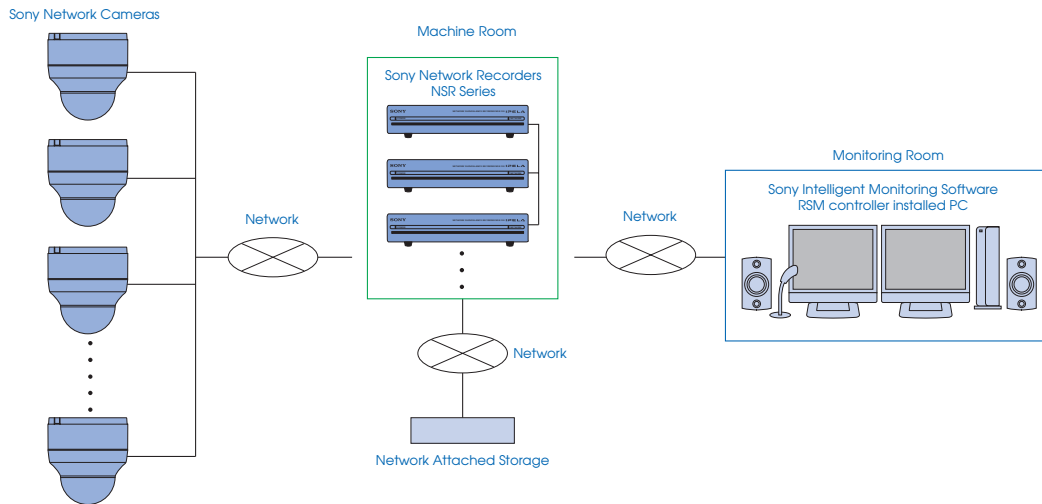

Dimensions

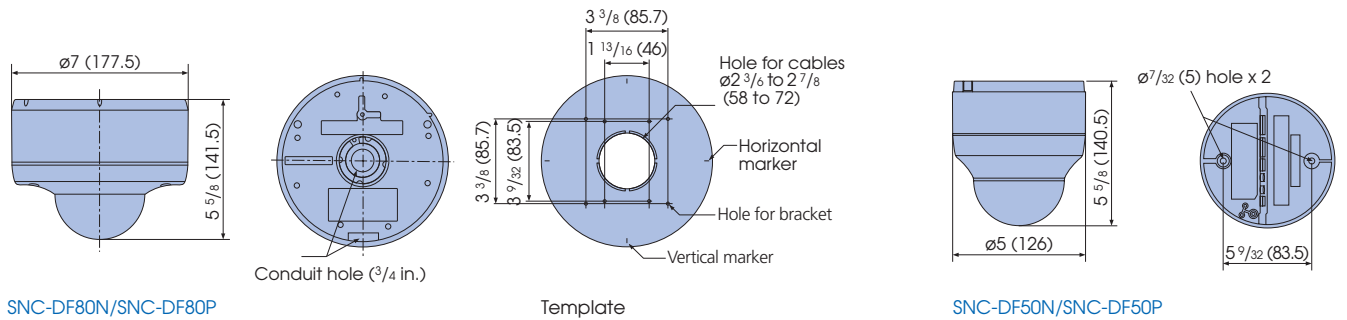

Unit: inches (mm)

Optional Accessories



YT-ICB45
In-Ceiling Mount
Bracket



YT-HU75
Heater Unit
SNC-DF80



Specifications

	SNC-DF80N	SNC-DF80P	SNC-DF50N	SNC-DF50P
Camera				
Image device	1/3-type CCD with SuperExwave Technology		1/3-type CCD with DynaView Technology	
Number of effective pixels (H x V)	380,000 (768 x 494)	440,000 (752 x 582)	380,000 (768 x 494)	440,000 (752 x 582)
Electronic shutter	1/60 to 1/10,000 s	1/50 to 1/10,000 s	1/60 to 1/10,000 s	1/50 to 1/10,000 s
Auto gain control	On/Off (0 dB to +24 dB)		Auto, EV compensation, DynaView	
Exposure control	Auto, Backlight compensation			
White balance mode	ATW, ATW Pro			
Lens type	Vari-focal lens			
Zoom ratio	3.6x optical zoom (1.5x digital zoom)			
Horizontal viewing angle	100.8° to 27.7°			
Focal length	f=2.8 to 10.0 mm			
F-number	F1.3 (wide), F3.0 (tele)			
Minimum object distance	300 mm			
Image				
Image size (H x V)	640 x 480, 320 x 240, 160 x 120 (JPEG, MPEG-4, H.264)			
Compression format	JPEG, MPEG-4, H.264			
Maximum frame rate				
JPEG/MPEG-4	30 fps (640 x 480)	25 fps (640 x 480)	30 fps (640 x 480)	25 fps (640 x 480)
H.264	10 fps (640 x 480)	8 fps (640 x 480)	10 fps (640 x 480)	8 fps (640 x 480)
Audio				
Audio compression	G.711/G.726 (40, 32, 24, 16 Kb/s)			
Network				
Protocols	TCP/IP, HTTP, ARP, ICMP, FTP, SMTP, DHCP, SNMP, DNS, NTP, RTP/RTCP			
Number of clients	20			
Authentication	IEEE802.1X			
Interface				
Ethernet	10Base-T/100Base-TX (RJ-45)			
Card slot	CF card x1			-
Analog video output	BNC x1, 1.0 Vp-p, 75 Ω, RCA x 1			
I/O port	Sensor in x 1, Alarm out x 2			
External microphone input	Mini-jack (monaural, 2.2 K 2.5 V plug-in power)			
Audio line output	Mini-jack (monaural), max output level: 1 Vrms			
Analog video output				
Signal system	NTSC (Composite)	PAL (Composite)	NTSC (Composite)	PAL (Composite)
Horizontal resolution	540 TV lines		480 TV lines	
S/N ratio	more than 50 dB			
Min. illumination	Color: 0.6 lx (50IRE, F1.3, AGC ON) B/W: 0.06 lx (50IRE, F1.3, AGC ON)		0.7 lx (50IRE, F1.3, AGC ON)	
General				
Weight	approx. 3 lb 15 oz (1.8 kg)		approx. 2 lb (920 g)	
Dimensions (Ø x H)	approx. 7 x 5 5/8 inches (177 x 141 mm)		approx. 5 x 5 5/8 inches (126 x 140 mm)	
Power requirements	PoE (IEEE-802.3af)/AC24V/DC12 V			
Power consumption	10 W max.		9 W max.	
Operating temperature	14 to 122 °F (-10 to 50 °C) -40 to 122 °F (-40 to 50 °C) w/heater unit		14 to 122 °F (-10 to 50 °C)	
Storage temperature	-4 to 140 °F (-20 to 60 °C)			
Supplied accessories				
	Bracket, Template, Torx wrench, M4 screws (4), Wire rope, M4 shoulder screw, Audio cable, I/O cable, CD-ROM (User's guide, IP setup program, Audio Upload Tool, Privacy Masking Tool, Video Player, Custom Homepage Installer), Installation manual		Template, Wire rope, M4 shoulder screw, AC power cord, Monitor cable, CD-ROM (User's guide, IP setup program, Audio Upload Tool, Privacy Masking Tool, Video Player, Custom Homepage Installer), Installation manual	
System requirements				
Operating system	Microsoft® Windows® 2000/XP			
Processor	CPU: Intel® Pentium® IV 1.5 GHz or higher (2.4 GHz or higher is recommended)			
Memory	RAM: 256 MB or more			
Web browser	Microsoft Internet Explorer® Ver. 6.0			

NOTES

- * The SNC-DF80N/DF80P and SNC-DF50N/DF50P include software developed by the OpenSSL project for use in the OpenSSL Toolkit. (<http://www.openssl.org/>)
- * The SNC-DF80N/DF80P and SNC-DF50N/DF50P include cryptographic software written by Eric Young (ey@cryptsoft.com)

Rear Panel



SNC-DF50N/DF50P

SONY

Sony Electronics Inc.
1 Sony Drive
Park Ridge, NJ 07656
www.sony.com/security



© 2007 Sony Electronics Inc. All rights reserved.
Reproduction in whole or in part without written permission is prohibited.
Features and specifications are subject to change without notice.
All non-metric weights and measurements are approximate.
Sony, IPELA, DEPA, SuperExwave, and DynaView are trademarks of Sony.