



MULTI-TENANT ENTRY SECURITY SYSTEM

GH Open Voice Audio & Video Series



• High Resolution Color Video Monitors for Added Security •



GH Multi-Tenant Entry Security System

Solutions for All Types of Residential & Commercial Buildings

In today's society, an increasing demand is placed on building security. An entry system must have certain criteria: it needs to match a tenant's lifestyle, must be reliable, simple to use, and economical to install. Aiphone's GH System meets all of these demands.

The GH System offers simple hands-free tenant stations, provides unparalleled reliability, and is backed by the best support in the industry. This system can accommodate up to 500 units, 16 entrance panels, and 4 security guard stations. Installation is quick and easy using no more than four wires, and the included programming software is intuitive to use.

When you use Aiphone, you're using products you can count on from a name you can trust.



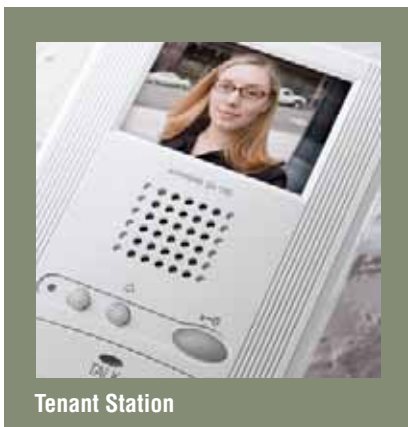

Tenant Station

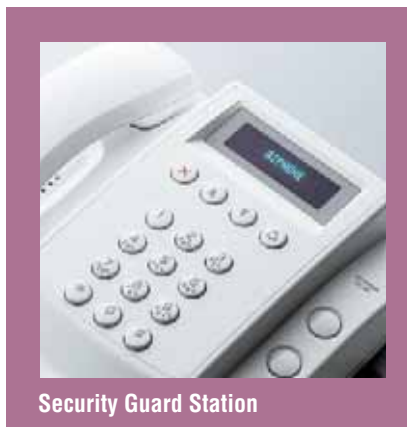

Security Guard Station

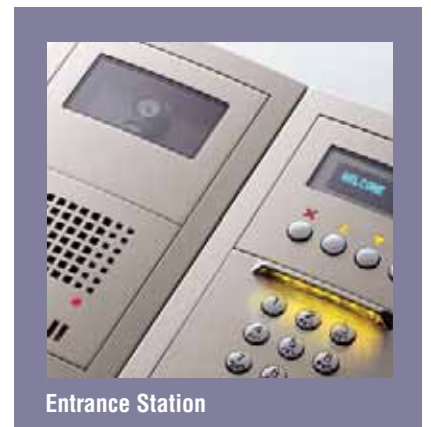

Entrance Station

The GH System offers several benefits over other traditional telephone-style entry systems. It's a direct connect system that does not require an outside phone line at the tenant location and will never incur additional phone company charges. This series improves security by requiring individuals to be at the tenant station to answer calls and grant access. In addition, the GH system offers security guard stations, open voice communication, and tenant monitoring of the entry.

TENANT STATION

- TENANT STATION
- SECURITY GUARD STATION
- ENTRANCE STATION



○ Select from five styles



GH-1KD*
Hands-free Color Monitor Tenant Station (white)
*GH-1KD-SB with functional service button



GH-1KDS*
Hands-free Color Monitor Tenant Station (silver)
*GH-1KDS-SB with functional service button



GH-1MD
Hands-free B&W Monitor Tenant Station (white)



GH-1AD*
Hands-free Audio Tenant Station (white)
*GH-1AD-SB with functional service button



GH-1KD with GH-HS
Hands-free Color Monitor Tenant Station with Optional Handset (white)

○ Up to 4 Units per Tenant

A maximum of 4 units per tenant allows calls from an entry to be answered from almost anywhere.

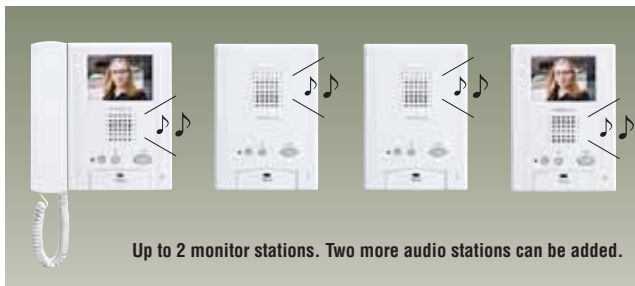

Up to 2 monitor stations. Two more audio stations can be added.

○ Entrance Monitoring

Tenants can monitor the entry areas. A call from any entry panel will have priority over tenant monitoring.

○ Compact, Elegant & Durable

The hands-free color video and audio stations offer compact, elegant styling, which is backed by one of the best warranties in the industry.

○ Handset Available

Optional handset is available for privacy (GH-1KD only)

○ Other Features

• Push-to-talk Function

For noisy environments, communication to the entry panel from the tenant can be push-to-talk instead of hands-free.

• External Signaling Device

A device*, such as a buzzer, a light, or a doorbell can be activated when the tenant station receives a call.

*Requires GH-RY Relay and #238400 connector (not included).

• Service Button*

An open contact function that can be used to turn on lights or call an elevator, etc.

*Order GH-1KD-SB or GH-1AD-SB for operational Service Button feature.

• Emergency Call to Security Guard Station

A separate switch* can be used to trigger calls to the security guard station.

*Use GFK-PS or any N/C switch.

• Automatic Door Release

The option to allow a tenant to automatically release the door lock when their unit is called.

*Requires #238400 connector (not included).
Not available when service button is used.

• Call Tone Off LED

LED blinks while call tone is muted.

• Doorbell

An optional doorbell can be connected at each tenant's door.



Color Video Helps Identify Visitors

- Color video monitor adds more security to individual tenants
- Available with hands-free, full color video monitors
- Tenants can clearly identify visitors using the high resolution TFT monitors

Installer-Friendly Terminal Block

- The terminal block can be removed from the station unit
- Makes installation easier and protects the station against theft during installation
- Available with GH-1KD, GH-1KDS, GH-1AD and GH-MK.





ENTRANCE STATION



2 Styles to Choose From

An entry panel can be configured in two ways: Digital Name Scrolling or Direct-Select. Digital Name Scrolling entry panels have a VFD* display for tenant names, 10-key pad for calling, and is an excellent solution for larger complexes. A Direct-Select entry panel can be configured to the exact number of tenants in a building and features a name card next to each button for identification.

*Vacuum Fluorescent Display



Direct-select call buttons

Digital Name Scrolling

Always Crystal Clear Color Video

A built-in white illumination LED automatically activates in low light and night time conditions to provide clear video images to the tenant stations.



Convenient Tenant Search

The digital scrolling entry panel allows visitors to easily find tenants by name or unit number (directory search by first letter is also available).



Customizable Welcome Message

Tenants are able to enter their own welcome message. Up to 160 alphanumeric characters can be used to greet visitors and give instructions on the entry's VFD panel.



Card Readers, Access Codes & Postal Lock

Up to 20 access codes are available to activate an electric door strike or magnetic lock. A module with an embedded HID® card reader is also available to allow tenants to use proximity cards for access into the building. The postal lock modules allow postal workers to gain entry access as well (GF-OP2, GF-OP3).

Easy Installation

Installation/Setup is Quick & Easy

- Simple wiring: 2 conductor for audio and 2 conductor for video
- Tenant data can be transferred from the first entrance panel to any additional entry panels and security guard stations
- GH-NS and GH-MK can be programmed via a PC
- All required software is included

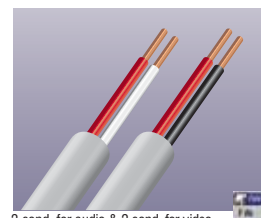

2 cond. for audio & 2 cond. for video

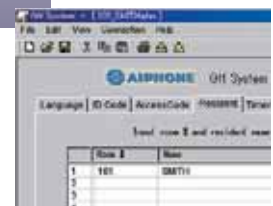

PC programmable

SECURITY GUARD STATION

TENANT
STATION

SECURITY
GUARD
STATION

ENTRANCE
STATION



Visitor Screening

All calls from entry panels can be routed through the security guard station(s). The security guard station can allow visitors to enter or transfer calls to the tenant(s).

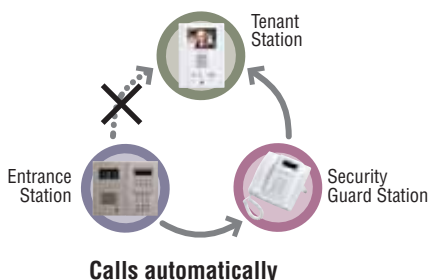

Caller ID with Callback

All calls to the security guard station display the name of the party calling, and up to 20 missed calls can be stored. Callback from the security guard/concierge is simply a matter of pressing the call button while a tenant's name is displayed.



Full System Connectivity

The security guard station can place and receive calls from all entry panels, tenant stations, and any other security guard stations.

Other Features

Receives Emergency Call from Tenant Stations

A separate switch* at the tenant station activates calls at the security guard station.
*Use GFK-PS or any N/C switch.

Doorbell (not supplied by Aliphone)

An optional doorbell can be connected.

Service Button

An open contact function* that can be used to turn on lights or call an elevator, etc.
*Requires #238400 connector (not included) plus unit modification.

External Signaling Device

A device* such as a buzzer, a light, or a doorbell can be activated when the security guard station receives a call.
*Requires GH-RY Relay and #238400 connector (not included).

Wall & Desktop Installation



SYSTEM COMPONENTS

Entrance Station

Direct-Select Call Button



Digital Name Scrolling



Audio Module



Digital Name Scrolling Module



Front Frames & Back Boxes



Video Module

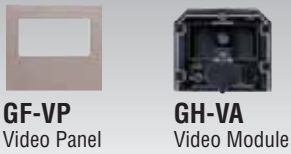

Call Switch Module

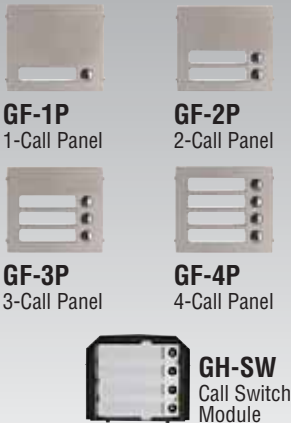

Options

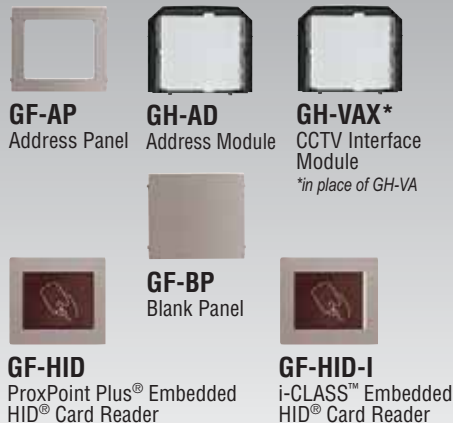

Entrance Station Components

Number of Call Buttons	4	8	12	16	20	24	25-500	GH-NS & GF-10K
(1) GH-VA / GF-VP	1 / 1	1 / 1	1 / 1	1 / 1	1 / 1	1 / 1	For more than 24 tenants, use the Digital Name Scrolling Entry Panel	1 / 1
(2) GH-DA / GF-DP	1 / 1	1 / 1	1 / 1	1 / 1	1 / 1	1 / 1		1 / 1
(3) GH-SW / GF-4P	1 / 1	2 / 2	3 / 3	4 / 4	5 / 5	6 / 6		—
(4) GH-2F / GF-2B	—	2 / 2	—	—	—	—		2 / 2
(5) GH-3F / GF-3B	1 / 1	—	2 / 2	2 / 2	3 / 3	3 / 3		—
(6) GF-BP GH-AD / GF-AP	— —	— —	— 1 / 1	— —	1 1 / 1	1 —		— —
(7) GH-NS / GF-NSP GH-10K / GF-10KP	— —	— —	— —	— —	— —	— —		1 / 1 1 / 1

(1) Video (2) Audio (3) Call Switch (4) 2-Module Front Frame (5) 3-Module Front Frame (6) Option (7) Digital Name Scroll

SYSTEM COMPONENTS

Tenant Station



GH-1KD*
Hands-free Color
Monitor Tenant
Station (white)
*GH-1KD-SB with
functional service button



GH-1KDS*
Hands-free Color
Monitor Tenant
Station (silver)
*GH-1KDS-SB with
functional service button



GH-1MD*
Hands-free B&W
Monitor Tenant
Station (white)
*GH-4Z required



GH-1AD*
Hands-free
Audio Tenant
Station (white)
*GH-1AD-SB with
functional service button



GH-HS for GH-1KD
Optional Handset
compatible with GH-1KD
(white)

Security Guard Station



GH-MK
Security Guard/
Concierge Station



GFW-S
Desktop Stand
for GH-MK

Entry Panel Kits



GHA-DES/A
Audio, VFD Directory,
and Digital Keypad Modules



GHV-DES/A
Video, Audio, VFD Directory,
and Digital Keypad Modules

Expanded Control Units



GH-BCX/A
Expanded Audio Control Unit
(mounting rail included)



GH-VBX
Expanded Video Control Unit
(mounting rail included)

Control Units



GH-BC
Audio Control Unit



GH-VBC
Video Control Unit

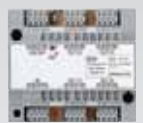

GH-4Z
4-Tenant Video
Distribution Unit

Power Supplies, Options & Accessories



PS-2420UL
Power Supply,
24V DC, 2A



GH-RY
External
Activation Relay



GHW-LC
Multi-Relay Control Unit
(For use with GH Expanded System only)



W-DIN11
DIN Mounting Rail
for GH control units



#238400
Option
Connector

SYSTEM CONFIGURATION*

Standard System

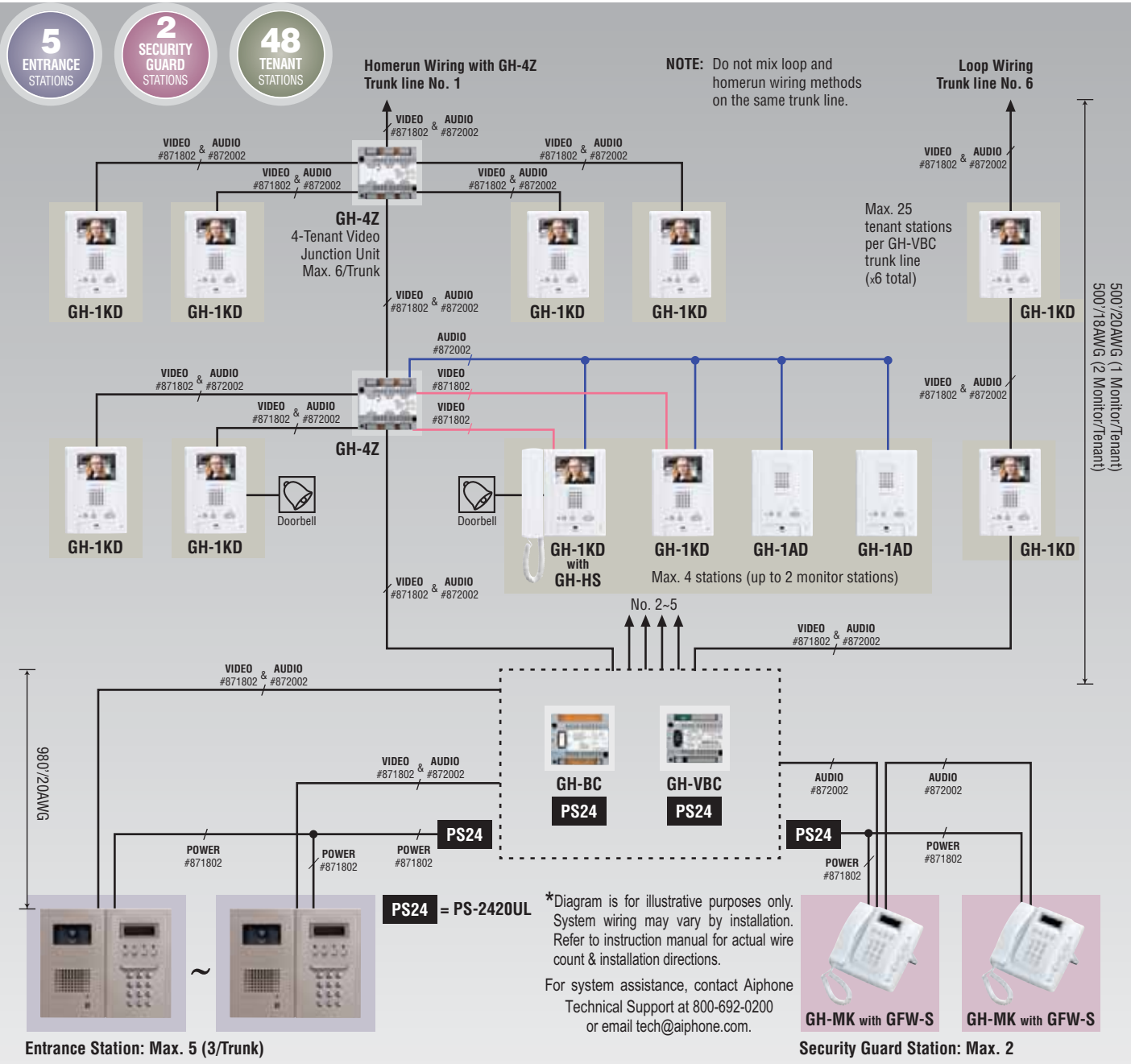

Wiring Distance

	22 AWG	20 AWG	18 AWG
GH-BC to Distribution point	—	16'	—
Distribution point to Entrance Station	—	980'	—
Distribution point to GH-MK	—	980'	—
Distribution point to farthest GH-1AD (Audio line)	—	980'	—
GH-VBC to farthest Monitor (Video line) 1 Monitor/Tenant	330'	500'	—
GH-VBC to farthest Monitor (Video line) 2 Monitors/Tenant	165'	330'	500'
GH-VBC (STD) to GH-VBC (EXP)	330'	500'	—
GH-BC/VBC to each Power Supply	—	16'	16'
GH-NS to Power Supply	—	980'	980'
GH-MK to Power Supply	—	980'	980'
Total cumulated wire distance (audio line)	—	8,200'	—

Entrance Station

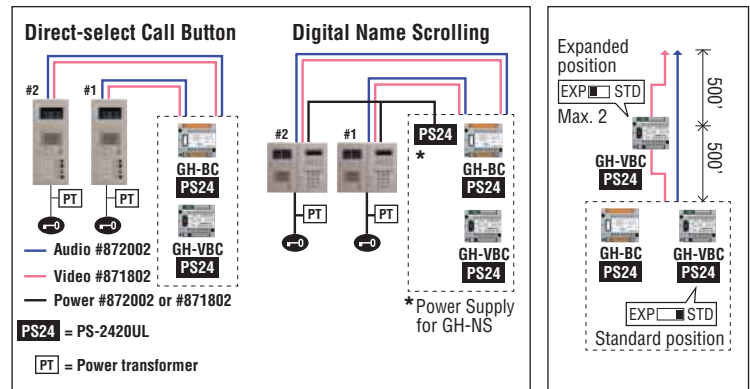

SYSTEM CONFIGURATION*

Expanded System

16
ENTRANCE
STATIONS

4
SECURITY
GUARD
STATIONS

500
TENANT
STATIONS

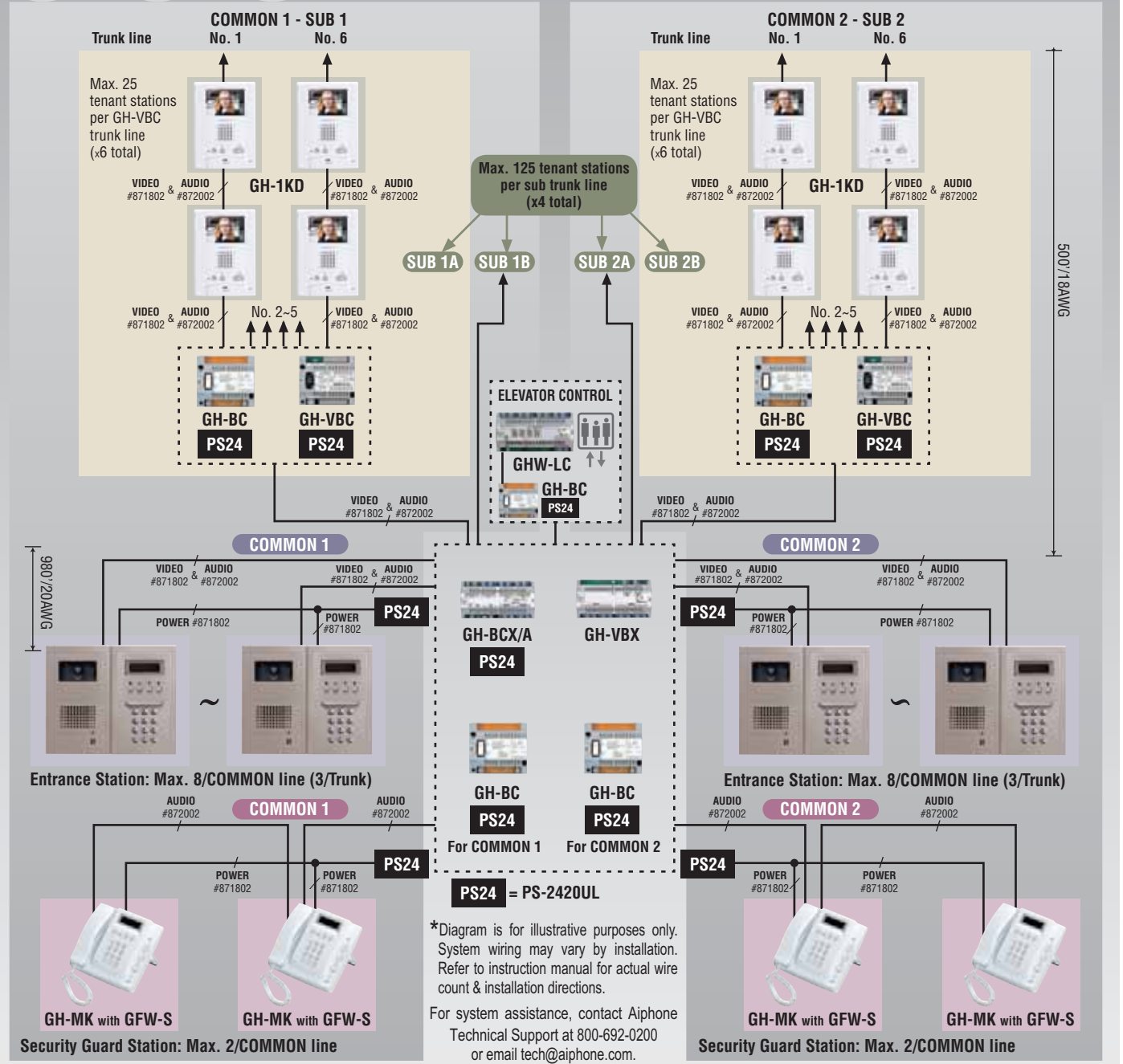

Wiring Distance

	22 AWG	20 AWG	18 AWG
GH-BCX/A to GH-BC	—	16'	—
GH-VBX to GH-VBC	—	16'	—
GH-BCX/A or GH-VBX to Entrance Station	500'	980'	—
GH-BCX/A to farthest GH-1AD (Audio line)	—	980'	—
GH-VBX to farthest Monitor (Video line) 1 Monitor/Tenant	330'	500'	—
GH-VBC to farthest Monitor (Video line) 2 Monitors/Tenant	165'	330'	500'
Cumulated total per COMMON trunk line (max. 2)	—	8,200'	—
Cumulated total per SUB trunk line (max. 4)	—	8,200'	—

Communication (talk and video) paths:

Communication paths on GH-BCX/A and GH-VBX are identified as "COMMON 1" and "COMMON 2". Each related COMMON-SUB trunk has its own communication path that can be used within itself for communication between Entrance and Tenant. Crossover to the other trunk is possible, but this will occupy both talk and video paths on both sub trunks. Security guard or concierge communication also occupies the entire system.

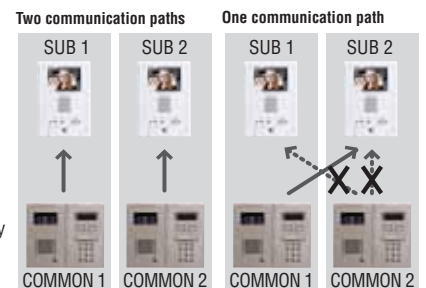

GH Series vs. GF Series

	GH Series	GF Series
Total Tenant Stations	500 tenant stations	250 tenant stations
Number of Tenant Stations within a Residence	Up to 4 stations (up to 2 video stations)	Up to 2 stations
Total Entrance Stations	16 stations	5 stations
Total Security Guard Stations	4 stations	2 stations
Wiring Distance (Entrance Station to GH-VBC)	980 feet	330 feet
Talk & Video Path	Secure single channel	Single channel, handset
Video Monitor	GH-1KD & GH-1KDS: 3.5 inch color LCD GH-1MD: 4 inch B&W CRT	4 inch B&W CRT
Type of Communication	Hands-free, voice-actuated or push-to-talk communication	Full-duplex with handset
Back Light for GH-NS & GH-MK	Vacuum Fluorescent Display	LCD with LED backlight
Visitor Screening	Available	Not available
Monitoring Entrance	Available from Tenant Station	Not available
Caller ID with Callback	Available, stores up to 20 calls	Not available
Additional Call Signaling Device at Tenant Station	Available with GH-RY Relay	Available with modifications
Selective Contacts	Available with GHW-LC Multi-Relay Control Unit (GH Expanded System only)	Not available
Link Programming	Program single entrance station or security guard station and transfer data to others	Program each entrance station & security guard station individually
Save Link Information to PC	Available - upload & download with Tenant information	Not available
Programmable Room No. Displayed on GH-NS & GH-MK	From 1 to 6 digits, alpha-numeric	3 or 4 digit, numeric only

Unit Dimensions

Direct-select Call Button

4-Call Direct Select

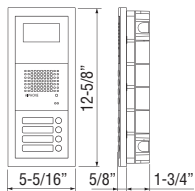

Digital Name Scrolling

GHV-DES/A

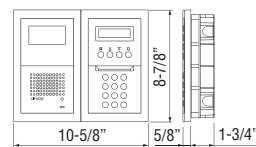

GHA-DES/A

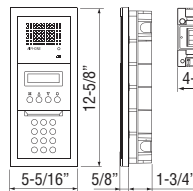

GH-BC, GH-VBC, GH-4Z



GH-BCX/A, GH-VBX, GHW-LC



GH-MK



GH-MK



GH-MK



GH-MK



GH-MK



GH-MK



GH-1KD, GH-1KDS

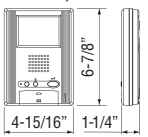

GH-1MD

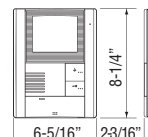

GH-1AD

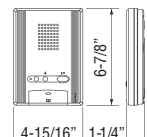

GH-HS

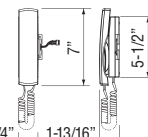

PS-2420UL

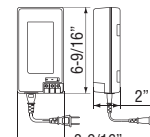

Specifications

Power Supply	24V DC - Use PS-2420UL
Current Consumption	GH-BC: 0.9 A GH-VBC: 0.9 A GH-NS: 0.13 A GH-MK: 0.18 A GH-BCX/A: 0.35 A
Call Tone	There are three different types of call tones: from entrance station, security guard station, and doorbell
Talk & Video Path	Secure single channel
Communication	Hands-free, voice-actuated communication or push-to-talk communication
Door Release	Connecting terminals: between ELM - ELC (N/O) and ELB - ELC (N/C) Specifications: less than 4A (resistance load), 24V AC/DC, dry closure contact
Wiring	Two conductor cables (Aiphone #872002 for audio and Aiphone #871802 for video)
Type of Cables	Pair cable (solid wire - not stranded), polyethylene insulated, low cap, diameter 20AWG-18AWG

Back Box Dimensions

Two 2-Module Back Boxes

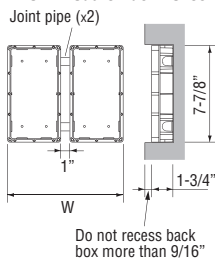

Three 3-Module Back Boxes

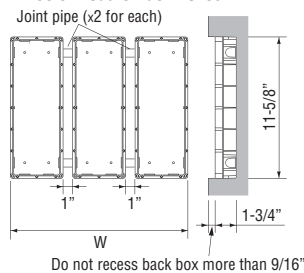

Back Box Total Width

GF-2B/3B	W (inch)
x 1	4-5/16"
x 2	9-5/8"
x 3	15"
x 4	20-1/4"

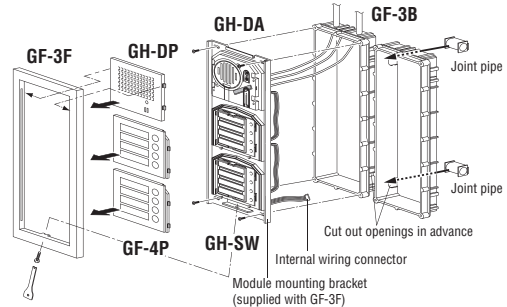

Distributed by:



#94214

GH Brochure 5/09
Printed in the USA



GS-35F-0065L

ISO-14001
Certified



Aiphone Co. Ltd.

ISO 9001:2000
Certified



Aiphone Corp.

Deming
Prize



Aiphone Co. Ltd.



Aiphone Corporation

1700 130th Ave. NE

Bellevue, WA 98005

Phone: (800) 692-0200

Fax: (425) 455-0071

www.aiphone.com/gb.htm