

Telecommunication Peripheral Products

Technical Practice

DVA-1003B

Three Channel
Digital Voice Announcer

October 14, 2004

3 Channel Non-Volatile Digital Voice Announcer with Remote Recording and Transfer Capabilities



The **DVA-1003B** is a fully professional, cost-effective three port digital voice announcer, specifically designed for ACD/UCD, auto attendant, call intercept, night messaging information provider and other PABX and Centrex announcement applications.

The **DVA-1003B** will increase call handling capacity by answering incoming calls on demand, or on the first ring, and automatically adjusts the announce time to the length of the outgoing message. The **DVA-1003B** will disconnect on CPC and provide instant "rewind" for the next caller.

The **DVA-1003B** is factory equipped with 1 full minute of non-volatile recording memory for each channel.

<http://www.VikingElectronics.com>

Features

- 1 minute of record time per channel
- Remotely recordable
- Locally recordable using a standard carbon handset or tape player
- Selectable ring delay per channel
- Detects CPC signal and disconnects
- Callers may be transferred after the announcement
- Messages stored in non-volatile memory (no batteries required)
- Recording volume LED indicator for consistently high-quality recordings
- Recognizes handshake signals from virtually any PABX, Centrex or C.O. line
- Programmable to repeat announcement

Sales...(715) 386 - 8861

Made in the U.S.A.

Applications

- ACD/UCD announcements
- Intercept announcement
- Announce-only applications
- School closings
- Ski reports
- Night answer
- Wake-up calls
- Bank rates/commodity prices
- Any application where information must be repeated continuously and may require frequent updating
- Replace existing tape and drum recorders

Specifications

Power: 120V AC/12V DC 500 mA, UL listed adapter provided or -24 to -58V DC @ 100mA maximum

Dimensions: 44mm x 483mm x 127mm (1.75" x 19" x 5")

Shipping Weight: 3 Kg (7 lbs)

Environmental: 0°C to 32°C (32°F to 90°F) with 5% to 95% non-condensing humidity

Message Length: 1 minute per channel

Connections: (3) RJ11 jacks, (3) 4-wire E&M jacks, (3) 1/8 audio jacks (3) handset jacks, (2) screw terminals

Sampling Rate: 64 K (equivalent)

Installation

A. Installing the DVA-1003B

Rear View of the DVA-1003B

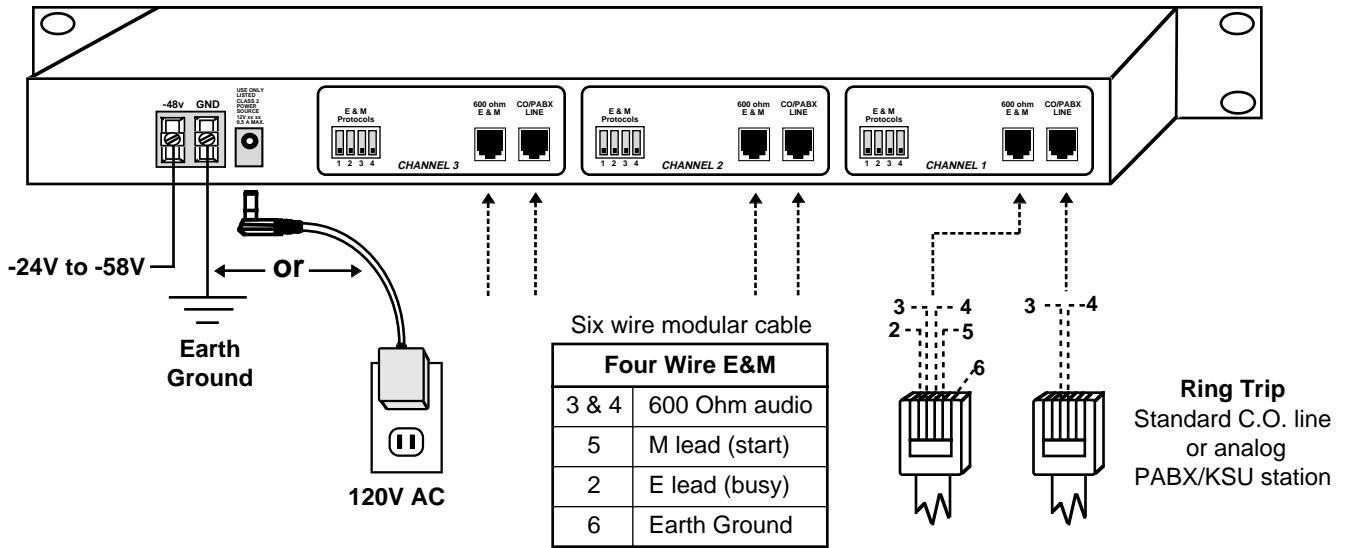

Wire each channel of the **DVA-1003B** with either or both the 4 wire E&M jack and/or the 2 wire ring trip jack as shown above. When using the 4 wire E&M, the ring trip interface may be used for remote programming. The E&M functions will resume when programming is finished.

Note: The **DVA-1003B** requires a 24 hour unswitched 115V AC outlet. To protect the internal electronics, the installation of a surge protector is recommended.

Programming

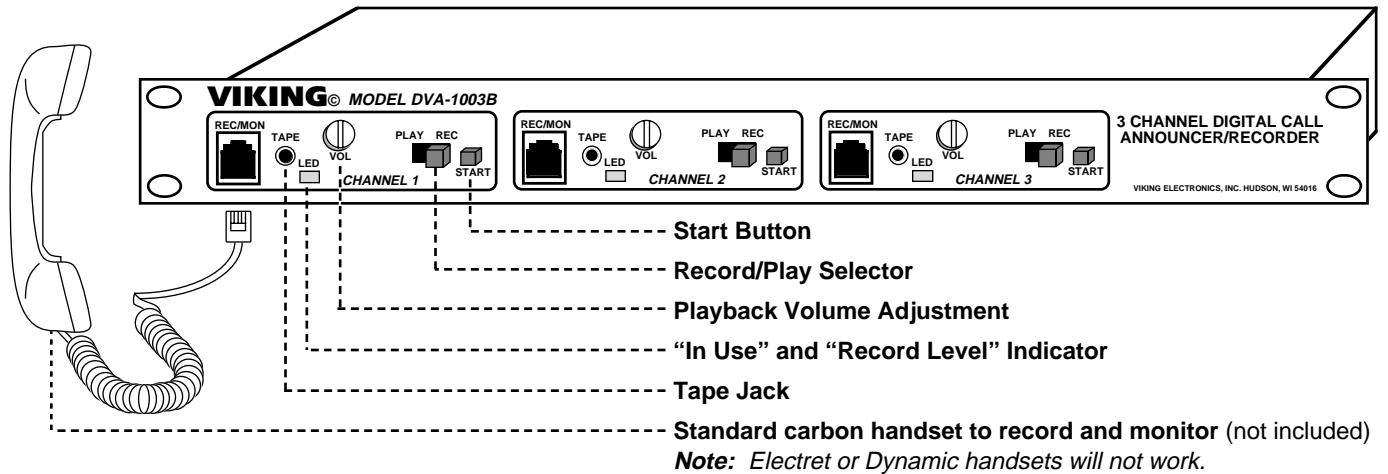

A. Continuous Play

Set dip switches to protocol "A" (Sw 1 and Sw 2 - **OFF**). Connect pin 5 (start) to pin 2 (busy) on the **600 OHM E & M** jack. The announcement will be repeated continuously on pins 3 and 4 (600 ohm output).

B. E & M Protocol Settings and Timing Specifications

Three different protocol settings are switch selectable for changing E&M timing plus the ability to invert the start and/or busy signals. Each channel is set up separately.

| Protocol | Sw 1 | Sw 2 |
|----------|------|------|
| A | OFF | OFF |
| B | OFF | ON |
| C | ON | OFF |

| Switch | Position | Description |
|--------|----------|----------------|
| 3 | ON | Inverted Start |
| | OFF | Normal |
| 4 | ON | Inverted Busy |
| | OFF | Normal |

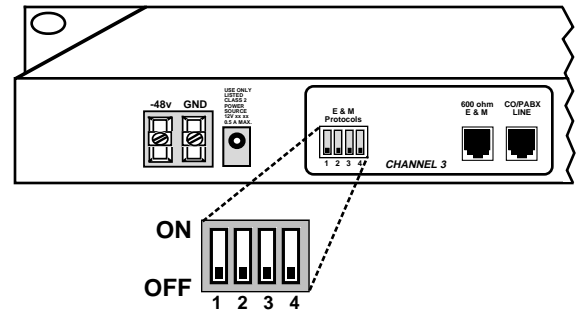

Note: Set switches with the unit powered down.

1. “On Demand”. Set dip switches to protocol “A” (Sw 1 and Sw 2 - OFF).

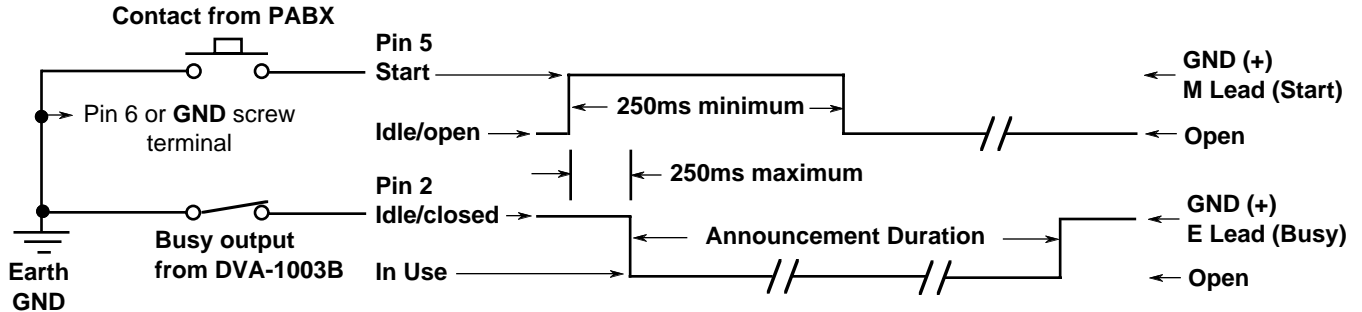

2. Type 5 E & M, wink start. Set dip switches to protocol “B” (Sw 1 - OFF, Sw 2 - ON).

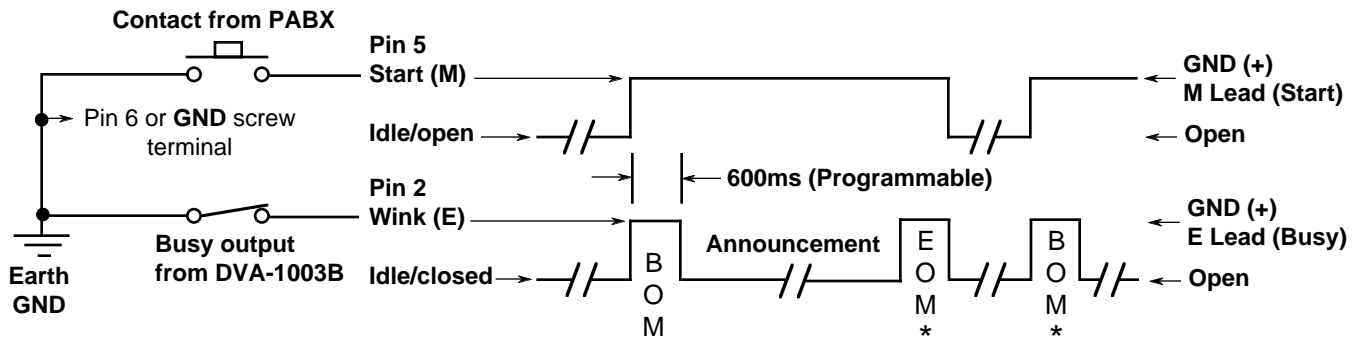

3. Drum Recorder Replacement. Set dip switches to protocol “A” (Sw 1 and Sw 2 - OFF).

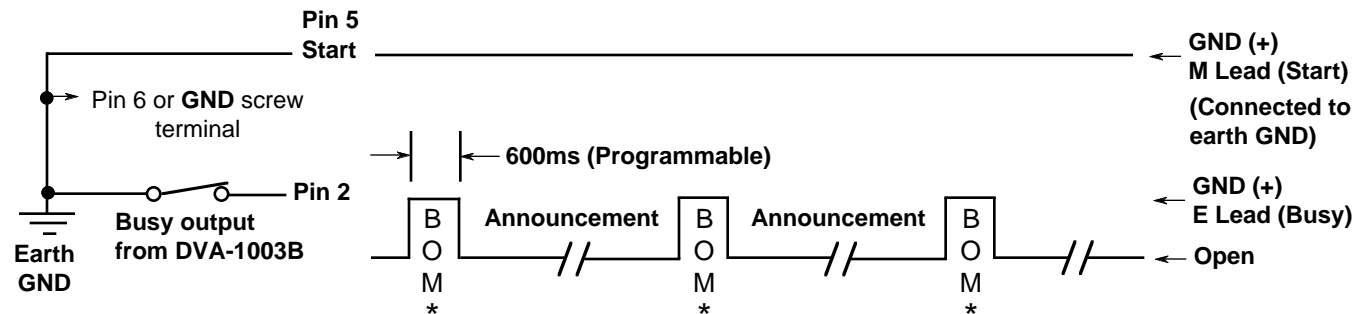

4. Single Play On Demand. Set dip switches to protocol “C” (Sw1 - ON, Sw 2 - OFF).

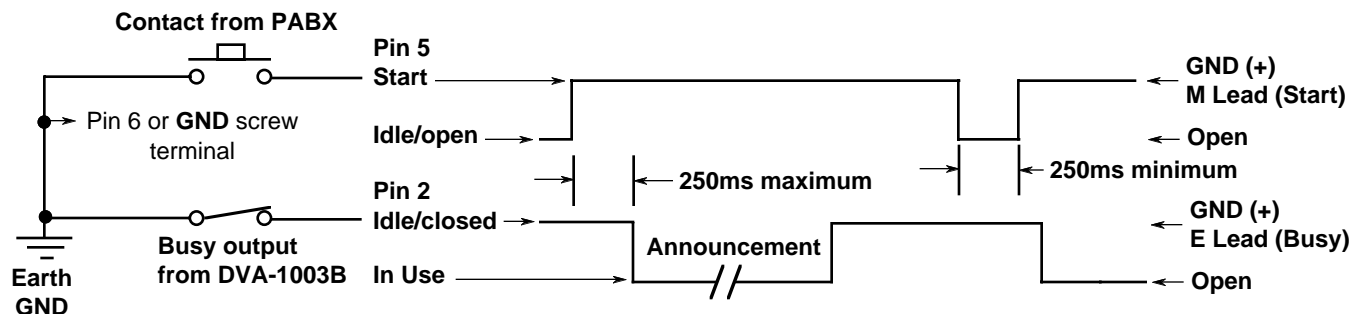

***Note:** BOM = “Beginning Of Message” pulse. EOM = “End Of Message” pulse.

C. Recording Locally From a Carbon Handset

1. Place the **PLAY/REC** switch in the **REC** position.
2. Plug a standard carbon handset into the modular **REC/MON** jack.
3. Press and hold the **START** switch and begin speaking as if you were talking on the telephone.
4. When finished release the **START** switch.
5. Place the **PLAY/REC** switch in the **PLAY** position.

D. Recording Locally From a Tape Player

1. Place the **PLAY/REC** switch in the **REC** position.
2. Insert a 3.5mm (1/8") audio plug into the **TAPE** jack.
3. Connect the other end of the cable assembly to the speaker, monitor, earphone, etc. jack of a standard cassette recorder.
4. To adjust the audio level of the tape player.
 - a. Play the recording but do not push **START**.
 - b. Adjust the cassette player volume so that the LED flickers but is not mostly on or off.
5. Press and hold the **START** switch for the duration of the recording.
6. When finished release the **START** switch.
7. Place the **PLAY/REC** switch in the **PLAY** position.

E. Monitoring Locally From a Carbon Handset

1. Place the **PLAY/REC** switch in the **PLAY** position.
2. Plug a standard carbon handset into the modular **REC/MON** jack.
3. Press and hold the **START** switch for the duration of the message.
4. When finished release the **START** switch.

Note: While playing or recording, the "LED" will display a steady light.

F. Recording/Programming Remotely From a Touch Tone Phone

1. Accessing the Remote Recording/Programming Mode

Note: Each channel is programmed separately.

- a. Call the C.O. line or analog PABX/KSU extension connected to the 2 wire ring trip port.
- b. When that channel of the **DVA-1003B** answers, enter a **★**.
- c. After the recording stops, enter your security code (factory set to 845464). Two beeps should be heard.
- d. You are now in the remote recording/programming mode.
- e. A valid entry will be signaled with two beeps. An invalid entry will be signaled with three beeps.

2. Remote Recording

- a. After entering the programming mode, enter **★1**, wait for the start tone.
- b. Begin recording your message. Enter **#** to stop the recording.
- c. To review the announcement, enter **★3**, or hang-up and wait 20 seconds for the unit to disconnect, then call in.
- d. Enter **#** to stop message playback.

3. Programming the Ring Delay Remotely

- a. After entering the programming mode, enter the desired ring delay (**0 - 9**).
- b. Enter **#45**.

4. E & M Timing

The Beginning Of Message and End Of Message pulse width is factory set to 600ms. This may be programmed from 100ms (Touch Tone **1**) to 900ms (Touch Tone **9**). Enter **1 - 9, #46**.

5. Repeat Announcement

When in programming enter **01-99, #44** to have the announcement play from 1 to 99 times.

6. Changing the Security Code

It is recommended that you change the security code from the **845464** factory setting to your own personal 6 digit number. To change the security code, enter **6 digits #47**. *Note: The security code cannot contain a **★** or **#**.*











7. Transfer Option

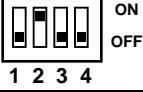

When in programming enter the extension number, up to 16 digits, followed by **#00**. Dial ****** for a *****, ***#** for a **#** and ***7** for a four second pause. **Note:** See **Operation** for phone system requirements.

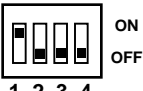
8. To Leave the Remote Programming Mode

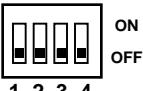
Simply hang-up and that channel of the **DVA-1003B** will time-out and disconnect.

G. Using the DVA-1003B with Major PABX's

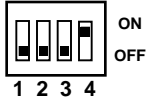
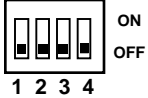
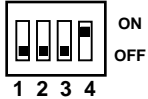
| Manufacturer | Protocol Dip Switches | Notes * Earth ground is the positive of the PABX system talk battery |
|---|--|--|
| ATT (Dimension, Horizon, etc. 4 Wire E & M) | Protocol "A" with inverted busy signal  | Use 4 Wire E & M Interface. Connections: T & R to pins 3 & 4, M to pin 5, E to pin 2 and Earth Ground* to pin 6. |
| ATT (System 75) | Protocol "A" with inverted busy signal  | For more information, contact Viking Product Support at (715) 386-8666. |
| ATT (System 85) SN231 Circuit Pack | Protocol "A" with inverted busy signal  | Use 4 Wire E & M Interface. Connections to SN231 Circuit Pack. T & R to pins 3 & 4, S to pin 5, and AL to pin 2. Set option switches 1 & 2 down and 3 up on the Circuit Pack. |
| Conveyant | Protocol "A"  | Use 4 Wire E & M Interface. Connections: T & R to pins 3 & 4. Strap pin 5 (from the DVA-1003B) to pin 6 (of the DVA-1003B). Don't connect any Earth Ground. RC-T1 (control input) lead to pin 2. CONVEYANT logic ground to pin 1. |
| GTE | Protocol "A" with inverted start signal  | Use 4 Wire E & M Interface. Connections: T & R to pins 3 & 4, M to pin 5, E to pin 2 and Frame Ground to pin 6. |
| Harris (20-20) | Protocol "B"  | Use 4 Wire E & M Interface. Connections: T1 & R1 to pins 3 & 4. M to pin 5. E to pin 2. Earth ground* to pin 6. |
| Hitachi (HCX 5000) | Protocol "A" with inverted busy signal  | For more information, contact Viking Product Support at (715) 386-8666. |
| N.E.C. (2400) | Protocol "C"  | Use 4 Wire E & M Interface. Connections to 40DT card: T1 & R1 to pins 3 & 4. M to pin 5. Earth ground* to pin 6. |
| Northern (SL-1) QPC74 Ran Trunk | Protocol "A"  | Use 4 Wire E & M Interface. Connections to QPC74 RAN TRUNK circuit pack: T & R to pins 3 & 4. CPO to pin 2. S/MBO to pin 5. Earth ground* to pin 6. Set C34 switch as follows: SW1.0 - closed, SW2.0 - closed, SW3.0 - open, SW4.0 - closed. Programming the SL-1: The DVA-1003B emulates a Cook 201. |
| Northern (SL-1) Universal trunk card | Protocol "A"  | Use 4 Wire E & M Interface. Connections to Universal TRUNK card: T & R to pins 3 & 4. Earth ground* to pin 6. Pin 5 to MB lead. Pin 2 to CP lead. The DVA-1003B emulates a Audiochron RQ1-112. |
| Siemens (Saturn) | Protocol "A"  | Use 4 Wire E & M Interface. Connections to the TMBA-4 card: T & R to pins 3 & 4. MA to pin 5. Strap MA & EB together. Don't connect EA lead. Program Saturn for "Recann" and "Demand" and set "System Message" to be a min. of 2 sec. longer than actual announcement. Strap TMBA-4 for type 2 signaling. |

| Manufacturer | Protocol Dip Switches | Notes * Earth ground is the positive of the PABX system talk battery |
|--|--|---|
| Siemens (40/80 Hybrid) | Protocol "A" with inverted busy signal  | For more information, contact Viking Product Support at (715) 386-8666. |
| Startel | Protocol "A"  | Use 4 Wire E & M Interface. Connections: T & R to pins 3 & 4, M to pin 5, E to pin 2. No connection to pin 6. |
| Stromberg-Carlson (CO switch) | Protocol "A" with inverted busy signal  | Use 4 Wire E & M Interface. Connect T & R to pins 3 & 4, Earth Ground* to pin 6 and pin 5, and E to pin 2. Strap the E & M Trunk card the same as for an Audichron HQ1 112 Drum Announcer. Programming the CO switch: The DVA-1003B emulates the Audichron Drum Announcer. |
| Stromberg-Carlson (DBX) | Protocol "C" with inverted start and busy signals  | Use 4 Wire E & M Interface. Connections: T & R to pins 3 & 4, M to pin 5, E to pin 2. Earth Ground* to pin 6. |
| Tadaran (All models) | | Use Ring Trip Interface. Connect T & R to pins 3 & 4 of the CO/PABX line jack. Program all DVA-1003B channels for ring delay of 2. |
| Jistel (all models) Mitel (all models) Rolm (all models) Toshiba (perception) | | Use Ring Trip Interface. Connect T & R to pins 3 & 4 of the CO/PABX line jack. |

Operation

A. Ring Trip Interface

1. **Standard** - Any ringing C.O. line or analog PABX/KSU station will be answered after the programmed ring delay, given the announcement and released. That channel of the **DVA-1003B** is then immediately ready to answer the next incoming call.
2. **Announcement Repeat Option** - An announcement may be programmed to be repeated up to 99 times. When in programming, enter the announcement repeat value (**01 - 99**) followed by **#44**. The announcement will then be repeated up to the programmed value, or until the caller hangs up and the **DVA-1003B** detects a CPC signal from the C.O. line. Callers that do not hang-up may then be transferred to another extension of the phone system (see **Transfer Feature** below).
3. **Transfer Feature** - A ringing C.O. line will be answered after the programmed delay, hear the announcement, and then be transferred to another extension of the phone system. This feature may only be used on analog PABX/KSU stations or Centrex lines with "blind" hookswitch-flash transfer capabilities. Specifically, this requires that a basic "2500" set can perform a hookswitch flash transfer and ring another extension, which is not required to answer before the first extension releases the call. When in programming, enter the number of the extension to be transferred to (up to 16 digits) followed by **#00**. To disable this feature, when in programming simply enter **#00** without any station prefix.

B. Four Wire E & M

The **600 OHM E & M** jacks provide a 600 ohm "Dry" output. Refer to E & M protocol settings and timing on pages 3 and 4, and the PABX table on pages 5 and 6 for proper operation.

Product Support Line...(715) 386-8666

Fax Back Line...(715) 386-4345

Due to the dynamic nature of the product design, the information contained in this document is subject to change without notice. Viking Electronics, its affiliates and/or subsidiaries assume no responsibility for errors and/or omissions contained in this information. Revisions of this document or new editions of it may be issued to incorporate such changes.