

CUBE-iT PLUS® CABINET SYSTEM

KEY FEATURES

- Swing-out cabinet body enables easy access to the rear of installed equipment.
- Rear panel is pre-punched with knockouts for 1/2", 3/4", 2-1/2" and 3" conduit, and has interior cable tie points and attachment points for accessory rack-mount brackets.
- Cabinet body includes one pair of adjustable depth 19" EIA threaded equipment mounting rails.
- Cabinet body is vented. Vents will accept an accessory fan.
- Front door has rounded edges and corners and is available solid or with a tinted window.
- The front door and the rear panel lock to provide equipment security.

APPLICATIONS

- Store and secure communications equipment — a horizontal cross connect or a consolidation point — within a telecommunications room or a public space.

USE WITH

- 45° Mounting Bracket for CUBE-iTPLUS
- 90° Mounting Bracket for CUBE-iT PLUS
- Termination Block Panel for CUBE-iT PLUS
- Vertical Mounting Bracket for CUBE-iT PLUS
- Fan Kit for CUBE-iT PLUS
- Power Strip for CUBE-iT PLUS
- Light for CUBE-iT PLUS
- Rubber Foot Kit for CUBE-iT PLUS
- Horizontal Wire Management Bar for CUBE-iT PLUS
- Vertical Cable Manager for CUBE-iT PLUS

RELATED ACCESSORIES

- Universal Horizontal Cable Managers
- Double-Sided Universal Horizontal Cable Managers
- Saf-T-Grip® Reusable Cable Management Straps
- Combination Pan Head, Pilot Point, Mounting Screws



36" High Wall-Mount Cube-iT



72" High Wall- and Floor-Supported Cube-iT

CUBE-iT PLUS® Cabinet System is a series of wall-mounted and floor-supported telecommunications enclosures designed to secure communications equipment for a cross connect. CUBE-iT PLUS Cabinets are copper and fiber ready and feature easy access to the front or the rear of the cabinet.

The cabinet design delivers exceptional strength and rigidity. The cabinet can be attached to the wall to swing open from the right or left. The open and close motion is smooth and the hasp used to secure the cabinet body to the rear panel assists in drawing the body components together during the locking action. Additionally, the door may be attached to open from the right or left. Door and rear panel are keyed alike.

The 5"D (130 mm) rear panel provides a space for terminating cables. The rear panel is pre-punched along the top and bottom with conduit knockouts allowing communications and power cables to be securely routed into the cabinet. Grommets are included to protect cables when conduit is not used. The interior of the rear panel has tie points for cables and attachment points for accessory equipment mounting brackets.

The main cabinet body includes a pair of adjustable depth 19" EIA threaded equipment mounting rails that can be used to support interconnect equipment and/or active components. The sides of the cabinet body are vented and will accept an accessory fan kit to increase air changes in the cabinet. The front door can be solid or have a tinted window. The edges of the front door are rounded to protect passers-by.

CUBE-iTPLUS Cabinets are available in five heights, 18 sizes. There are two basic cabinet styles. The 24"H (610 mm), 36"H (910 mm) and 48"H (1220 mm) cabinets attach directly to the wall, are UL Listed, and are available in four depths and support 200 pounds (90.7 kg) of equipment. The 60"H (1520 mm) and 72"H (1830 mm) cabinets attach directly to the wall and are floor-supported by a wheeled base under the main cabinet body (adds approximately 6" (150 mm) to overall height). The 60"H (1520 mm) and 72"H (1830 mm) cabinets are available in three depths and support 1,000 pounds (453.6 kg) of equipment.

See inside for product selection. Contact CPI for configuration assistance.



CHATSWORTH PRODUCTS, INC.

Sold by:



+1-800-834-4969

techsupport@chatsworth.com
www.chatsworth.com

SPECIFICATIONS

24"H (610 mm), 36"H (910 mm), 48"H (1220 mm) CUBE-iT PLUS

- Wall-mount enclosure with lockable front door and swing-out rear access to equipment
- Patented hinge design allows the installer to remove the rear panel for easier installation on the wall
- For indoor use only, in environmentally controlled areas; may not be used outdoors, in harsh environments, or in air-handling spaces
- Available sizes:
Heights: 24" (610 mm), 36" (910 mm), 48" (1220 mm)
Widths: 24" (610 mm); 19" EIA rack-mount
Depths: 13" (330 mm), 18"(460 mm), 24" (610 mm), 30" (760 mm)
- Usable interior space:
Heights: 12 RMU, 18 RMU, 26 RMU
Widths: 19" EIA rack-mount
Depths: refer to dimensions, at right
- Cable access:
(4) 1/2" or 3/4" knockouts, 2 top/2 bottom
(8) 2-1/2" or 3" knockouts, 4 top/4 bottom
(4) Edge-protection grommets are included for 3" knockouts
- Cable fill:
Refer to TIA-569-B and NEC for conduit fills
Estimated cable pass through at 3" knock-through edge-protection grommet:

Cat 5e (.220" OD)	Cat 6 (.275" OD)	Cat 6A (.350" OD)
38	25	15

- Equipment support:
1 pair L-shaped equipment mounting rails in the main cabinet body
- 19"W, EIA-310-D compliant
- Universal hole pattern, 5/8"-5/8"-1/2" vertical hole spacing
- Threaded #12-24 equipment mounting holes
- Depth-adjustable (bolted in place) 5"D (130 mm) rear panel punched to accept accessory equipment mounting brackets, see dimensions at right, accessories on back page Includes 50 each #12-24 equipment mounting screws
- Vertical cable management:
Cable lacing points on the side of equipment mounting rails
- Load capacity:
200 pounds (90.7 kg) of equipment, open or closed
- Certifications:
EIA-310-D compliant
UL Listed, NWIN with UL60950
- Material:
Steel sheet cabinet body, rear panel and door
Door window is bronze acrylic sheet
Equipment mounting rails are aluminum sheet
- Construction:
Riveted & Bolted
- Finish:
Epoxy-polyester hybrid powder coat paint
Black or computer white



DIMENSIONS

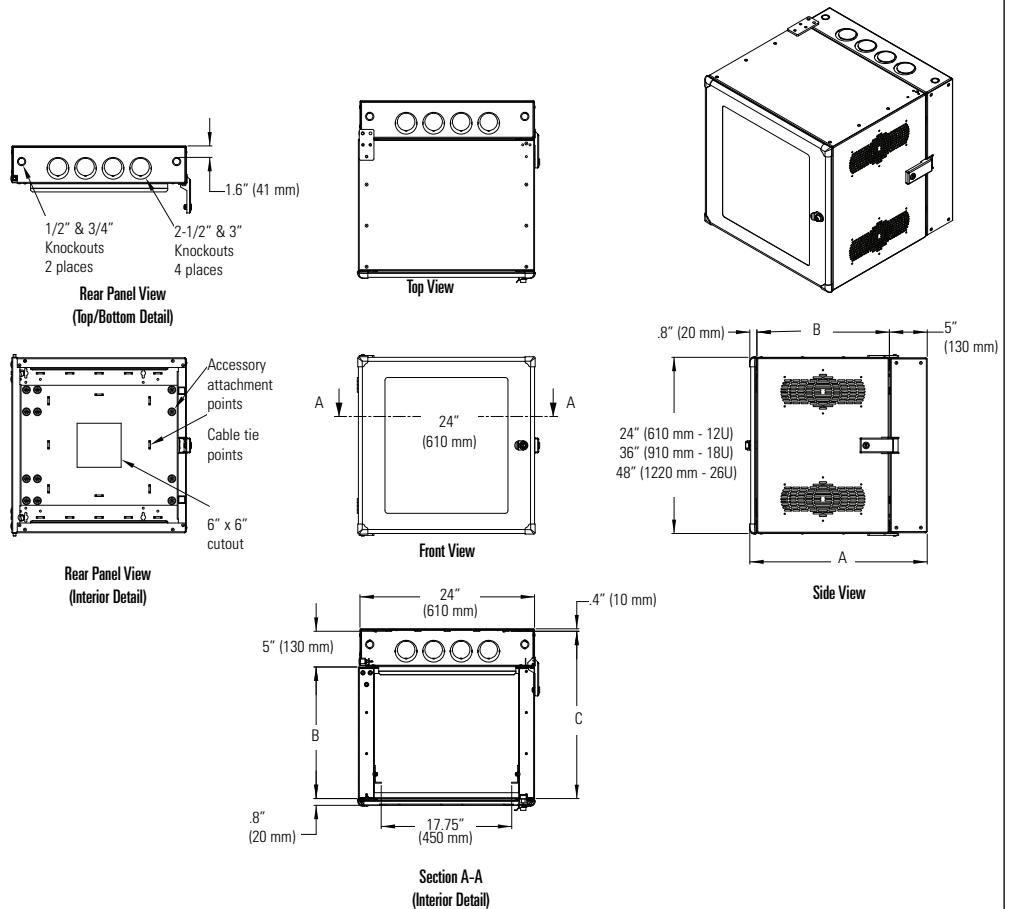

Depth		
Overall A	Cabinet Body B	Max. Equipment C
13" (330 mm)	7.2" (183 mm)	11.8" (300 mm)
18" (460 mm)	12.2" (310 mm)	16.8" (427 mm)
24" (610 mm)	18.2" (462 mm)	22.8" (579 mm)
30" (760 mm)	24.2" (615 mm)	28.8" (732 mm)

ORDERING INFORMATION

24”H (610 mm), 36”H (910 mm), 48”H (1220 mm) CUBE-iT PLUS Cabinets

- Attaches to the wall with included installation hardware
- Supports 200 pounds of equipment

24”H (610 mm) CUBE-iT PLUS Cabinets				
Part Number & Color		Door Style	Depth	Shipping Weight
White	Black			
13265-224	13265-724	Solid	13” (330 mm)	70 lb (31.8 kg)
13275-224	13275-724	Tinted	13” (330 mm)	67 lb (30.4 kg)
11890-224	11890-724	Solid	18” (460 mm)	78 lb (35.4 kg)
11901-224	11901-724	Tinted	18” (460 mm)	75 lb (34.0 kg)
11840-224	11840-724	Solid	24” (610 mm)	87 lb (39.5 kg)
11900-224	11900-724	Tinted	24” (610 mm)	84 lb (38.1 kg)
11996-224	11996-724	Solid	30” (760 mm)	97 lb (44.0 kg)
12419-224	12419-724	Tinted	30” (760 mm)	94 lb (42.6 kg)

Extra Mounting Rails, 1 Pair		
12787-524	L-shaped, threaded, 12 RMU	3 lb (1.4 kg)

Floor-Mount Foot Kit		
13483-001	Foot Kit, 24”D (610 m) & 30”D (760 mm) Cabinets Only	2 lb (0.9 kg)

36”H (910 mm) CUBE-iT PLUS Cabinets				
Part Number & Color		Door Style	Depth	Shipping Weight
White	Black			
13265-236	13265-736	Solid	13” (330 mm)	89 lb (40.4 kg)
13275-236	13275-736	Tinted	13” (330 mm)	83 lb (37.6 kg)
11890-236	11890-736	Solid	18” (460 mm)	99 lb (44.9 kg)
11901-236	11901-736	Tinted	18” (460 mm)	93 lb (42.2 kg)
11840-236	11840-736	Solid	24” (610 mm)	111 lb (50.3 kg)
11900-236	11900-736	Tinted	24” (610 mm)	105 lb (47.6 kg)
11996-236	11996-736	Solid	30” (760 mm)	124 lb (56.2 kg)
12419-236	12419-736	Tinted	30” (760 mm)	118 lb (53.5 kg)

Extra Mounting Rails, 1 Pair		
12787-536	L-shaped, threaded, 18 RMU	4 lb (1.4 kg)

Floor-Mount Foot Kit		
13483-001	Foot Kit, 24”D (610 m) & 30”D (760 mm) Cabinets Only	2 lb (0.9 kg)

48”H (1220 mm) CUBE-iT PLUS Cabinets				
Part Number & Color		Door Style	Depth	Shipping Weight
White	Black			
13265-248	13265-748	Solid	13” (330 mm)	108 lb (49.0 kg)
13275-248	13275-748	Tinted	13” (330 mm)	101 lb (45.8 kg)
11890-248	11890-748	Solid	18” (460 mm)	121 lb (54.9 kg)
11901-248	11901-748	Tinted	18” (460 mm)	114 lb (51.7 kg)
11840-248	11840-748	Solid	24” (610 mm)	135 lb (61.2 kg)
11900-248	11900-748	Tinted	24” (610 mm)	128 lb (58.1 kg)
11996-248	11996-748	Solid	30” (760 mm)	151 lb (68.5 kg)
12419-248	12419-748	Tinted	30” (760 mm)	143 lb (64.9 kg)

Extra Mounting Rails, 1 Pair		
12787-548	L-shaped, threaded, 26 RMU	5 lb (2.3 kg)

Floor-Mount Foot Kit		
13483-001	Foot Kit, 24”D (610 m) & 30”D (760 mm) Cabinets Only	2 lb (0.9 kg)

Note: Floor-Mount Foot Kit allows the front door and rear panel of the cabinet to open when it is placed on the floor, a shelf or table surface (not attached to a wall). Attaches under the 24”D or 30”D cabinets only.

Note: Refer to page 2 for details on these cabinets.

60”H (1520 mm), 72”H (1830 mm) CUBE-iT PLUS Cabinets

- Attaches to the wall with included installation hardware
- Cabinet body is supported by a wheeled base, adds 6” (150 mm) to height
- Supports 1,000 pounds of equipment

60”H (1520 mm) CUBE-iT PLUS Cabinets				
Part Number & Color		Door Style	Depth	Shipping Weight
White	Black			
13491-260	13491-760	Solid	18” (460 mm)	201 lb (91.2 kg)
13494-260	13494-760	Tinted	18” (460 mm)	192 lb (87.1 kg)
13492-260	13492-760	Solid	24” (610 mm)	221 lb (100.2 kg)
13495-260	13495-760	Tinted	24” (610 mm)	212 lb (96.2 kg)
13493-260	13493-760	Solid	30” (760 mm)	246 lb (111.6 kg)
13496-260	13496-760	Tinted	30” (760 mm)	236 lb (107.0 kg)

Extra Mounting Rails, 1 Pair			
13276-260	13276-760	L-shaped, 33 RMU	12 lb (5.4 kg)

72”H (1830 mm) CUBE-iT PLUS Cabinets				
Part Number & Color		Door Style	Depth	Shipping Weight
White	Black			
13491-272	13491-772	Solid	18” (460 mm)	224 lb (101.6 kg)
13494-272	13494-772	Tinted	18” (460 mm)	212 lb (96.2 kg)
13492-272	13492-772	Solid	24” (610 mm)	247 lb (112.0 kg)
13495-272	13495-772	Tinted	24” (610 mm)	235 lb (106.6 kg)
13493-272	13493-772	Solid	30” (760 mm)	274 lb (124.3 kg)
13496-272	13496-772	Tinted	30” (760 mm)	262 lb (118.3 kg)

Extra Mounting Rails, 1 Pair			
13276-272	13276-772	L-shaped, 40 RMU	14 lb (6.4 kg)

Vertical Cable Manager

- Use in 60”H (1520 mm) and 72”H (1830 mm) cabinets only
- Openings align with RMU spaces; fingers manage patch cords
- 2.7”W x 5”D (69 mm x 130 mm) usable interior space
- Adjusts front-to-rear within the cabinet
- Managers must be installed before rack-mount equipment



Vertical Cable Manager		
Part Number	Description	Shipping Weight
13485-760	Cable Manager for 60”H (1520 mm) Cabinet, Black	9 lb (4.1 kg)
13485-772	Cable Manager for 72”H (1830 mm) Cabinet, Black	10 lb (4.5 kg)

Note: Refer to page 4 for details on these cabinets.

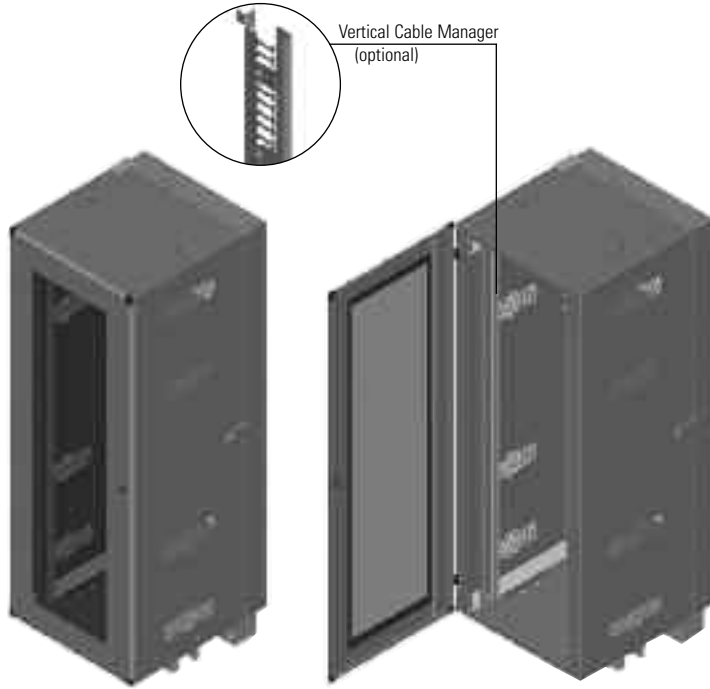

SPECIFICATIONS

60" H (1520 mm), 72" H (1830 mm) CUBE-iT Plus Cabinets

- Wall-mounted, floor-supported enclosure with lockable front door and swing-out rear access to equipment — the cabinet body is supported on the floor by an attached wheeled base
- For indoor use only, in environmentally controlled areas; may not be used outdoors, in harsh environments, or in air-handling spaces
- Available sizes:
 Heights: 60" (1520 mm), 72" (1830 mm)
 Widths: 27.3" (693 mm), 19" EIA rack-mount
 Depths: 18" (460 mm), 24" (610 mm), 30" (760 mm)
 Wheeled base adds approximately 6" to height
- Usable interior space:
 Heights: 33 RMU, 40 RMU
 Widths: 19" EIA rack-mount
 Depths: refer to dimensions, at left
- Cable access:
 (4) 1/2" or 3/4" knockouts, 2 top/2 bottom
 (10) 2-1/2" or 3" knockouts, 5 top/5 bottom
 (5) Edge-protection grommets are included for 3" knockouts
- Cable fill limits:
 Refer to TIA-569-B and NEC for conduit fills
 Estimated cable pass through at 3" knockout through edge-protection grommet:

Cat 5e (.220" OD)	Cat 6 (.275" OD)	Cat 6A (.350" OD)
38	25	15

DIMENSIONS

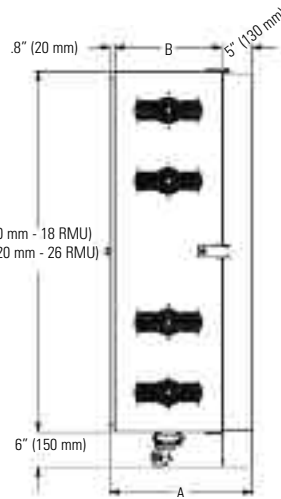
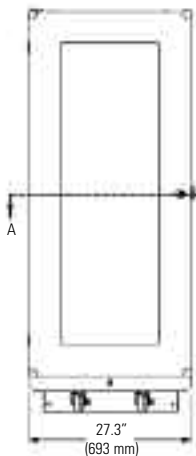
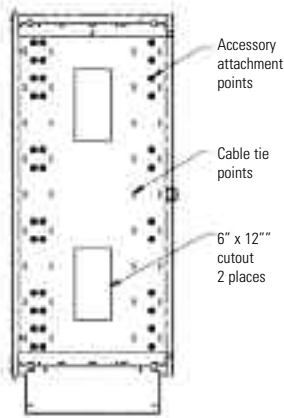
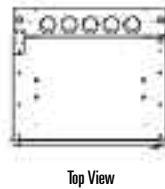
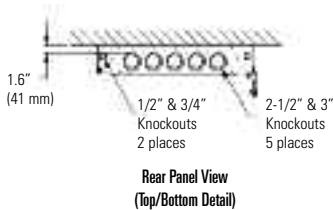

Rear Panel View (Interior Detail)

Front View

Side View

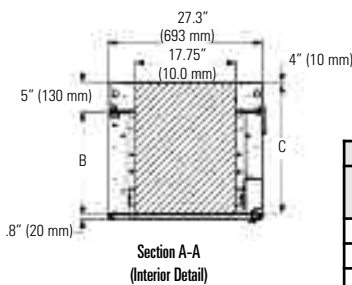

Depth		
Overall A	Cabinet Body B	Max. Equipment C
18" (460 mm)	12.2" (310 mm)	16.8" (427 mm)
24" (610 mm)	18.2" (462 mm)	22.8" (579 mm)
30" (760 mm)	24.2" (615 mm)	28.8" (732 mm)

- Vertical cable management:
 Integrated cable management space on both sides of the cabinet
 Support two vertical cable managers (sold as accessories) per side in 24"D (610 mm) and 30"D (760 mm) cabinets and one cable manager for 18"D (460 mm) cabinets
- Equipment support:
 1 pair C-shaped, 3"D (80 mm) equipment mounting channels in the main cabinet body
 - Front and rear equipment mounting
 - 19"W, EIA-310-D compliant
 - Universal hole pattern, 5/8"-5/8"-1/2" vertical hole spacing
 - Threaded #12-24 equipment mounting holes
 - RMU marked and numbered equipment mounting rails
 - Depth-adjustable (sliding, on support)
 - Marked support for easy vertical and depth alignment
 5"D (130 mm) rear panel punched to accept accessory equipment mounting brackets, see dimensions at left, accessories on back page
 Includes 50 each #12-24 equipment mounting screws
- Load capacity:
 1,000 pounds (453.6 kg) of equipment, open or closed
- Certifications:
 EIA-310-D compliant
- Material:
 Steel sheet cabinet body, rear panel and door
 Door window is bronze acrylic sheet
 Equipment mounting rails are aluminum extrusion
- Construction:
 Welded, riveted & bolted
- Finish:
 Epoxy-polyester powder coat paint
 Black or computer white

ACCESSORIES

45° Mounting Bracket

- Attaches to rear panel on CUBE-iT PLUS Cabinet
- Creates a 19" EIA x 3 RMU rack-mount space for patch panels

90° Mounting Bracket

- Attaches to rear panel on CUBE-iT PLUS Cabinet
- Creates a 19" EIA x 2 RMU vertical rack-mount space

Vertical Mounting Bracket

- Attaches to the equipment mounting rail in CUBE-iT PLUS Cabinet
- Creates a 19" EIA x 2 RMU or 19" EIA x 3 RMU vertical rack-mount space
- Supports 75 pounds (34 kg) of equipment

Termination Block Panel

- Attaches to rear panel on CUBE-iT PLUS Cabinet
- Supports (6) 110D-style 100-pair blocks or (4) 66-style blocks / H89D brackets

Fan Kit

- Attaches over the vents in the side of CUBE-iT PLUS Cabinet
- Fan draws air into the cabinet, pressurizing the cabinet and forcing warm air out of the side vents
- 115 VAC Fan with 5'L (1.5 m) attached power cord and NEMA 5-15 plug
- Optional Fan Kit
- UL Recognized

Power Strip

- Attaches to the bottom, top or side of CUBE-iT PLUS Cabinet
- 115 VAC 15 Amp or 20 Amp, 8 outlets, with 10'L (3 m) attached power cord and circuit breaker
- Optional surge-protection, select straight or locking plug style
- UL Listed

Note: CPI 20 outlet vertical power strips can be placed in 72"H (1830 mm) cabinets. 10 outlet vertical power strips can be placed in 60"H (1520 mm) and 72"H (1830 mm) cabinets

Interior Light

- Attaches to the bottom, top or side of CUBE-iT PLUS Cabinet
- 8 Watt fluorescent light with on/off switch
- 115 VAC with 6' (1.8 m) attached power cord and NEMA 5-15P plug
- 1 RMU rack-mount version also available

Horizontal Wire Management Bar

- Attaches to the rear of the equipment mounting rail in CUBE-iT PLUS Cabinet
- Secure premise cables after termination on patch panels
- Includes mounting hardware and 12 cable ties

45° Mounting Bracket



Fan Kit



90° Mounting Bracket



Power Strip



Vertical Mounting Bracket

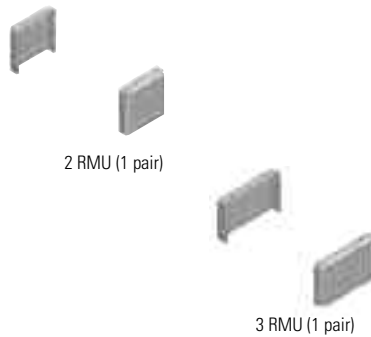

Interior Light



Termination Block Panel

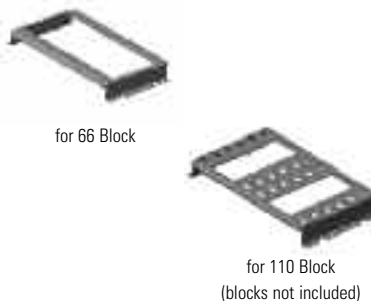

Horizontal Wire Management Bar



ORDERING INFORMATION

45° Mounting Bracket		
Part Number	Description	Shipping Weight
12796-501	3 RMU, 1 Pair, Clear	3 lb (1.4 kg)

90° Mounting Bracket		
Part Number	Description	Shipping Weight
13285-501	2 RMU, 1 Pair, Clear	3 lb (1.4 kg)

Vertical Mounting Bracket		
Part Number	Description	Shipping Weight
13286-501	2 RMU, 1 Pair, Clear	3 lb (1.4 kg)
13286-502	3 RMU, 1 Pair, Clear	3 lb (1.4 kg)

Termination Block Panel		
Part Number	Description	Shipping Weight
13287-501	19"W x 11.5"H, 66 Block, Clear	4 lb (1.8 kg)
13288-501	19"W x 11.5"H, 110 Block, Clear	4 lb (1.8 kg)

Fan & Filter Kits		
Part Number	Description	Shipping Weight
12804-701	Fan Kit, 115 VAC, 100 CFM	4 lb (1.8 kg)
12804-702	Fan Kit, 230 VAC, 100 CFM	4 lb (1.8 kg)
12805-201	Filter Kit, White	4 lb (1.8 kg)
12805-701	Filter Kit, Black	4 lb (1.8 kg)
12806-001	Filters, Box of 6	1 lb (0.5 kg)

Power Strips / 15 Amps		
Part Number	Description	Shipping Weight
12820-701	NEMA 5-15P	4 lb (1.8 kg)
12820-702	NEMA L5-15P	4 lb (1.8 kg)
12820-703	Surge-Protected, NEMA 5-15P	4 lb (1.8 kg)
12820-704	Surge-Protected, NEMA L5-15P	4 lb (1.8 kg)

Power Strips / 20 Amps		
Part Number	Description	Shipping Weight
12820-705	NEMA 5-20P	4 lb (1.8 kg)
12820-706	NEMA L5-20P	4 lb (1.8 kg)
12820-707	Surge, NEMA 5-20P	4 lb (1.8 kg)
12820-708	Surge, NEMA L5-20P	4 lb (1.8 kg)

Interior Light		
Part Number	Description	Shipping Weight
12803-701	Light	3 lb (1.4 kg)

Horizontal Wire Management Bar		
Part Number	Description	Shipping Weight
11837-201	White	2 lb (0.9 kg)
11837-701	Black	2 lb (0.9 kg)

Note: Refer to page 5 for details on these accessories.

