

Premium Grade Collection of Lighting Controls, Switches, Receptacles, Voice and Data and Wallplates.

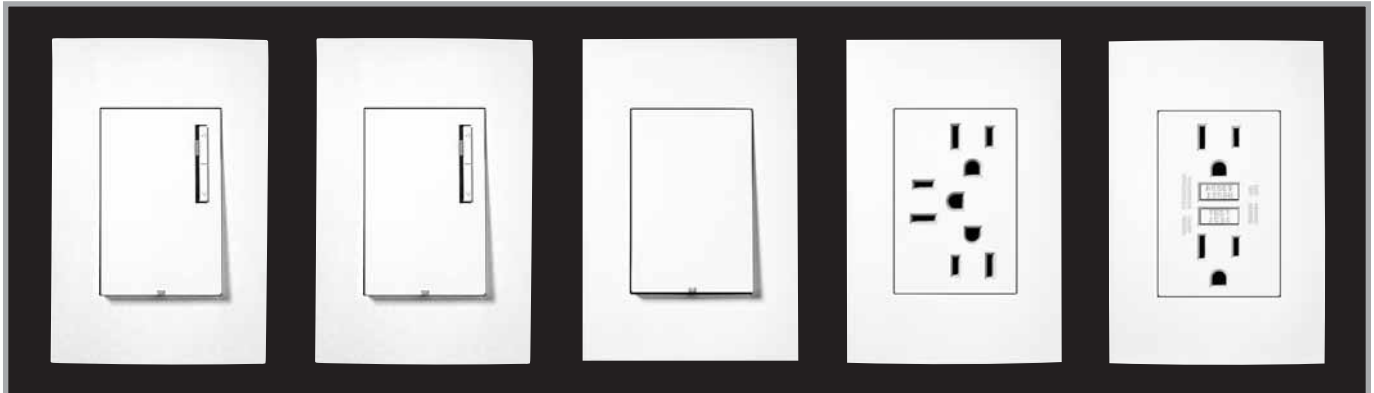

Electronic Dimmer
ACE06-1L

Matching Remote to
Dimmers/Fan
Speed Control
AC00R-1L

Electronic Switch
ACS15-1L

Triplex Receptacle
AC315

GFCI Receptacle
ACGF1

KEY PRODUCT FEATURES

- Efficient construction with consistent form factor, excellent ergonomic traits and precision feel
- Innovative contoured geometry offers an exclusive aesthetic design
- Flawless multi-gang installation with no dividers between devices
- All visible surfaces molded from engineering-grade polymer for uniformity and flawless color match
- Subtle, matte finish complements décor
- Blue LED serves as locator
- Premium Grade with Five-Year Limited Warranty
- Meet all applicable UL, CSA and FCC requirements

STANDARD FEATURES

- Universal design
- Quiet, crisp actuation, minimal travel
- Perfect alignment in multi-gang applications
- Multi-function self-grounding clip
- Screwless, snap-on wallplates



Acenti by Leviton SPECIFICATION SUBMITTAL

JOB NAME: <input type="text"/>	CATALOG NUMBERS: <input type="text"/>	
JOB NUMBER: <input type="text"/>	<input type="text"/>	<input type="text"/>





Leviton Manufacturing Co., Inc.
59-25 Little Neck Parkway, Little Neck NY 11362-2591
Customer Service: 1-888-4-ACENTI • FAX: 1-800-832-9538





Leviton Manufacturing of Canada, Ltd.
165 Hymus Boulevard, Pointe Claire, Quebec H9R 1E9
Customer Service: 1-800-469-7890 • FAX: 1-800-563-1853

Visit Leviton's Website at www.leviton.com/acenti

DIMMERS

For Single-Pole, 3-Way or More Applications

Description	Rating (For Multigang Installation see Derating Chart)	Cat. No.
 Incandescent with LED Locator and Brightness Display	600W-120VAC	ACI06-1L
 Magnetic Low-Voltage with LED Locator and Brightness Display	600VA-120VAC	ACM06-1L
 Incandescent/Magnetic Low-Voltage with LED Locator and Brightness Display	1000W-120VAC Incandescent 1000VA-120VAC Magnetic Low-Voltage	ACM10-1L
 Electronic Low-Voltage with LED Locator and Brightness Display	400W-120VAC	ACE04-1L



Description	Rating (For Multigang Installation see Derating Chart)	Cat. No.
 Electronic Low-Voltage with LED Locator and Brightness Display	600W-120VAC	ACE06-1L
 Mark 10™ <i>Powerline</i> or <i>Tu-Wire</i> ™ Fluorescent Dimmer with LED Locator and Brightness Display	1000VA- 120VAC	ACX10-1L
 Hi-lume® or Eco-10™ (Eco-Series) Fluorescent Dimmer with LED Locator and Brightness Display	8A-120VAC	ACH08-1L
 Quiet Fan Speed Control with LED Locator and Speed Display	1.5A-120VAC	ACF01-1L



DIMMER REMOTES

Description	Rating	Cat. No.
 Coordinating Dimmer Remote to 120VAC Dimmers/Fan Speed Controls for 3-way or up to 10 location applications (No LED)	120VAC No load rating	AC00R-10



Description	Rating	Cat. No.
 Matching Dimmer Remote to 120VAC Dimmers/Fan Speed Control for 3-way or up to 5 location applications, with LED Locator and Brightness Display	120VAC No load rating	AC00R-1L



ACENTI SWITCHES

Description	Rating	Cat. No.
 Electronic Switch with LED Locator For single-pole, 3-way or more applications	15A-120VAC	ACS15-1L
 Coordinating Switch Remote for 3-way or up to 10 location applications (No LED)	120VAC No load rating	AC0SR-10

Description	Rating	Cat. No.
 Matching Switch Remote for 3-way or up to 5 location applications, with LED Locator	120VAC No load rating	AC0SR-1L
 Single-Pole Electromechanical Switch with LED Locator	20A-120VAC	AC201-1L

ACENTI RECEPTACLES  

	Description	Rating	Cat. No.
	15A Triplex Receptacle	15A-125V NEMA 5-15R	AC315
	20A Triplex Receptacle	20A-125V NEMA 5-20R	AC320

	Description	Rating	Cat. No.
	15A Duplex Receptacle	15A-125V NEMA 5-15R	AC215
	20A Duplex Receptacle	20A-125V NEMA 5-20R	AC220

GFCI (GROUND FAULT CIRCUIT INTERRUPTER) RECEPTACLES  

	Description	Rating	Cat. No.
	15A Duplex GFCI Receptacle	15A-125V NEMA 5-15R Receptacle, 20A-125V Feed-Through	ACGF1

	Description	Rating	Cat. No.
	20A Duplex GFCI Receptacle	20A-125V NEMA 5-20R Receptacle 20A-125V Feed-Through	ACGF2

SURGE RECEPTACLE  



	Description	Rating	Cat. No.
	Duplex Receptacle with Indicator Light and Audible Alarm	15A-125V NEMA 5-15R	ACSSR

ACCESSORIES

Wallplates

Screwless, Snap-On Wallplates

- Alignment plate and positioning pins ensure perfect alignment of devices and wallplates in multi-gang installations
- For all Acenti devices

Engineering-Grade Polymer		Cat. No.	Brushed Stainless Steel		Cat. No.
	1-Gang	ACWP1		1-Gang	ACWM1
	2-Gang	ACWP2		2-Gang	ACWM2
	3-Gang	ACWP3		3-Gang	ACWM3
	4-Gang	ACWP4		4-Gang	ACWM4
	5-Gang	ACWP5		5-Gang	ACWM5
	6-Gang	ACWP6		6-Gang	ACWM6
1-Gang	Blank wallplate insert	ACW14	1-Gang		

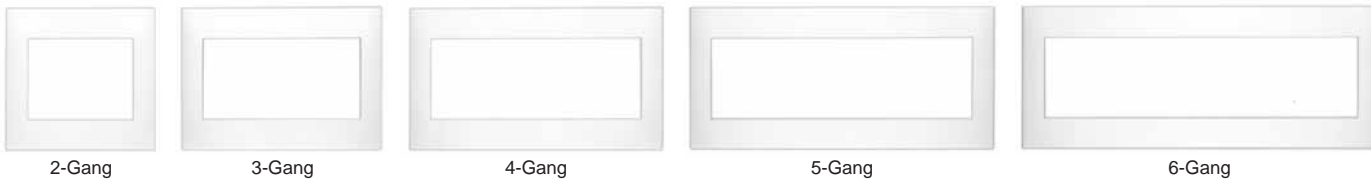

VOICE AND DATA

QuickPort® Wallplate Inserts

- Use with QuickPort® Snap-In connectors for data, audio and video applications
- Compatible with complete line of Acenti screwless, snap-on wallplates



4-Port

Description	Cat. No.
2-Port Insert	AC642
3-Port Insert	AC643
4-Port Insert	AC644
6-Port Insert	AC646

ACENTI COLORS

All Acenti devices (except brushed stainless steel wallplates) are available in the following designer colors. To order a color, add suffix indicated below to the catalog number.

Solid Colors: Alabaster (-W), Onyx (-E), Slate (-G)

Off-White Colors: Quartz (-Q), Sand (-S), Driftwood (-D), Natural (-A)

DERATING/MAXIMUM CAPACITY

Acenti controls do not have side sections. In multi-gang installations, fin removal is not required but devices must be derated in accordance with the following charts.

ACI06 Incandescent (Minimum load: 40W)

Gang	Maximum Wattage
1	600W
2	600W
3 or more	500W

ACM06 Magnetic Low-Voltage (Minimum load: 40VA)

Gang	Maximum VA	Maximum Bulb Wattage with 75% efficient transformer
1	600VA	450W
2	600VA	450W
3 or more	500VA	425W

ACM10 Incandescent/Magnetic Low-Voltage (Minimum load: 40W/VA)

Gang	Incandescent Maximum Wattage	Magnetic Low-Voltage Maximum VA	Magnetic Low-Voltage Maximum Bulb Wattage with 75% efficient transformer
1	1000W	1000VA	750W
2	800W	800VA	600W
3 or more	650W	650VA	487W

ACE04 Electronic Low-Voltage

Gang	Maximum Wattage
1	400W
2	350W
3 or more	250W

ACE06 Electronic Low-Voltage

Gang	Maximum Wattage
1	600W
2	500W
3 or more	400W

ACX10 Mark 10™ Powerline or Tu-Wire™ Fluorescent

Gang	Maximum VA
1	1000VA
2	800VA
3 or more	650VA

ACH08 Hi-lume® or Eco-10™ (Eco-Series) Fluorescent Dimmer

8A	No derating required
----	----------------------

ACF01 Quiet Fan Speed Control

1.5A	No derating required
------	----------------------

DIMENSIONS

All Dimmers, Quiet Fan Speed Control, Electronic Switch, Matching and Coordinating Dimmer and Switch Remotes

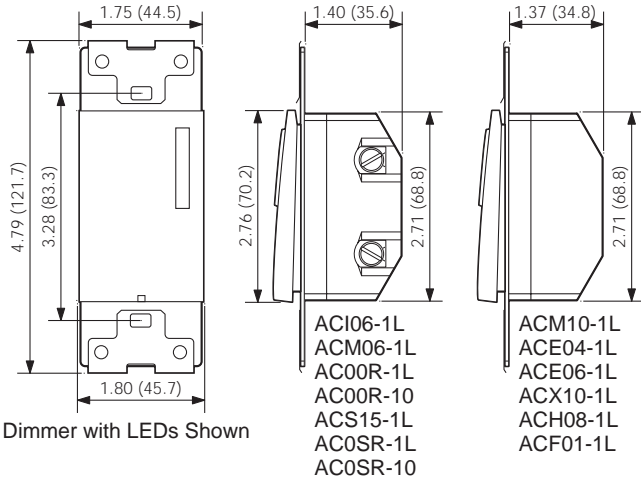

Electromechanical Switch

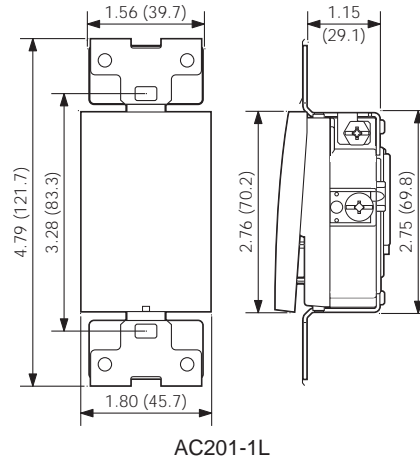

Triplex Receptacle

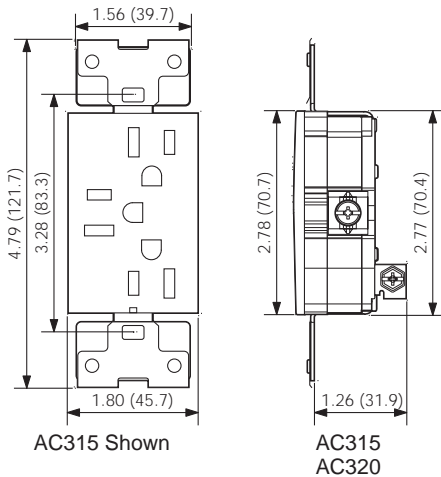

Duplex Receptacle

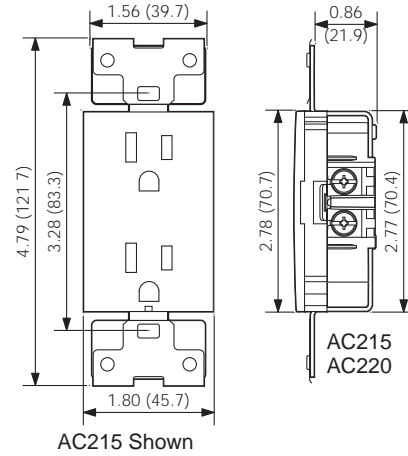

GFCI Receptacle

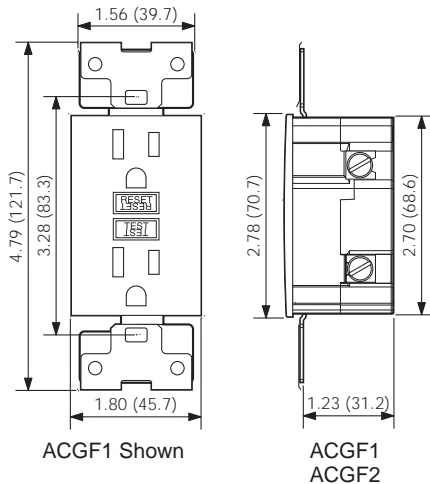

Surge Receptacle

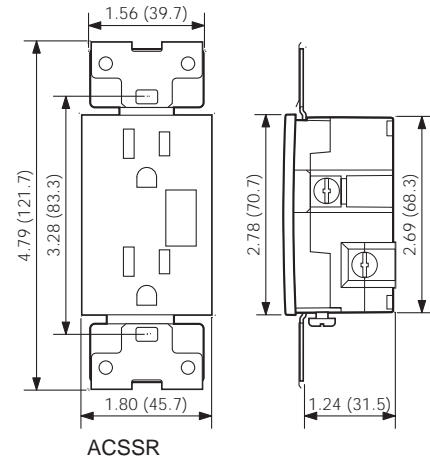

DIMENSIONS

Wallplates

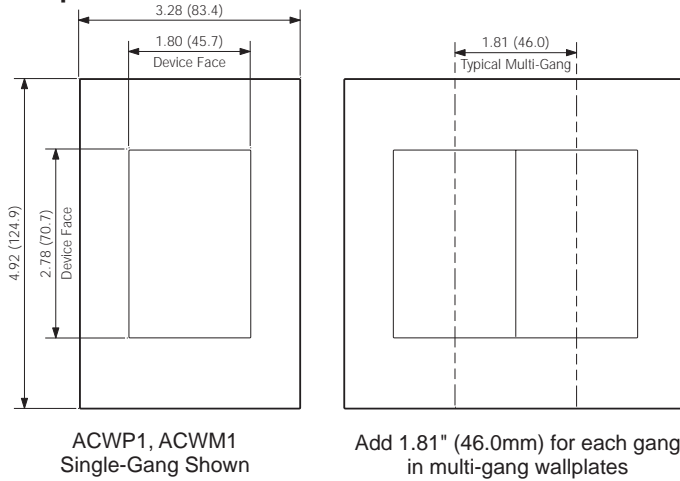

Voice & Data QuickPort® Wallplate Inserts

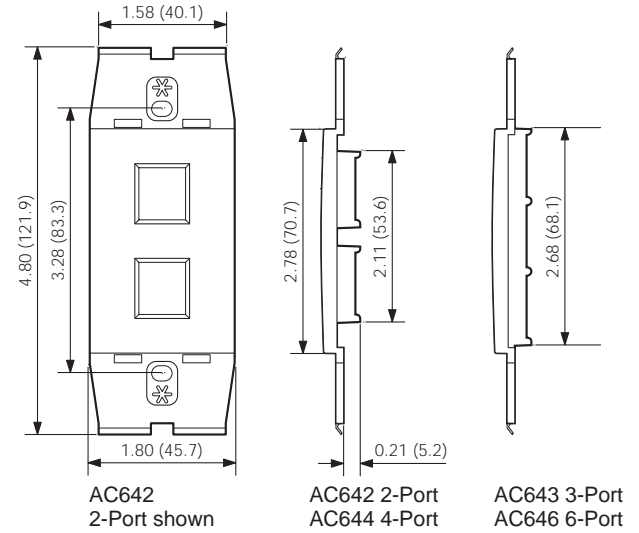

WIRING DIAGRAMS

Diagram 1

Single-pole wiring for incandescent or magnetic low-voltage dimmer.

Cat. Nos.

- ACI06
- ACM06
- ACM10

NOTES:

- 1) ACI06 and ACM06 have screw terminals, ACM10 has leads
- 2) Red and Black leads (or terminals) are interchangeable

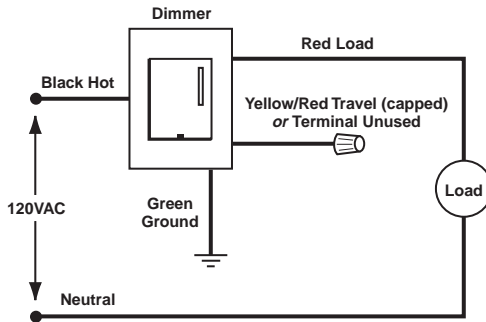

Diagram 2

Single-pole wiring for electronic low-voltage dimmer, Mark 10™ Powerline dimmer, fan speed control or switch.

Cat. Nos.

- ACE04
- ACE06
- ACX10
- ACF01
- ACS15

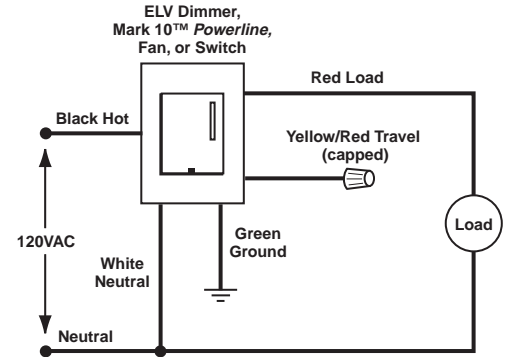

Diagram 3

3-Way wiring for incandescent or magnetic low-voltage dimmer with Coordinating Remote.

Cat. Nos.

- ACI06
- ACM06
- ACM10

Coordinating Remote

AC00R-10

NOTES:

- 1) ACI06 and ACM06 have screw terminals, ACM10 has leads
- 2) Coordinating Remote AC00R-10 has screw terminals
- 3) Black connections are interchangeable (see Diagram 4)
- 4) Silver terminal on Coordinating Remote is unused

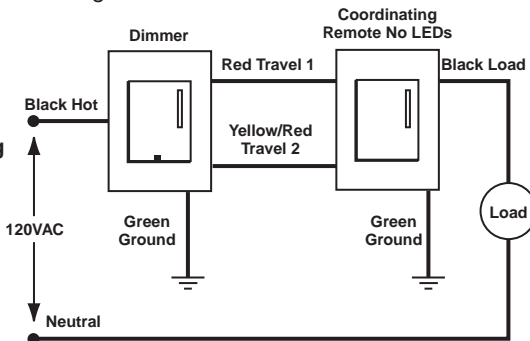

Diagram 4

Alternate 3-Way wiring for incandescent or magnetic low-voltage dimmer with Coordinating Remote.

Cat. Nos.

- ACI06
- ACM06
- ACM10

Coordinating Remote

AC00R-10

NOTES:

- 1) ACI06 and ACM06 have screw terminals, ACM10 has leads
- 2) Coordinating Remote AC00R-10 has screw terminals
- 3) Black connections are interchangeable (see Diagram 3)
- 4) Silver terminal on Coordinating Remote is unused

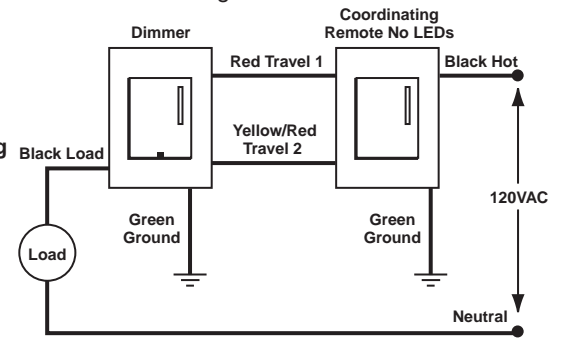

WIRING DIAGRAMS

Diagram 5

3-Way wiring for electronic low-voltage dimmer, Mark 10™ *Powerline* dimmer, fan speed control or switch with Coordinating Remote.

Cat. Nos.
ACS15
Coordinating Remote
AC0SR-10

Cat. Nos.
ACE04
ACE06
ACX10
ACF01
Coordinating Remote
AC00R-10

NOTES:

- 1) Coordinating Remotes AC0SR-10 and AC00R-10 have screw terminals
- 2) Black and Red terminals on Coordinating Remotes are unused

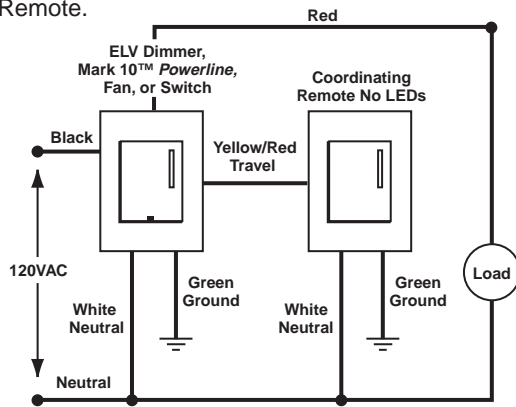

Diagram 6

3-Way wiring for incandescent or magnetic low-voltage dimmer with Matching Remote.

Cat. Nos.
ACI06
ACM06
ACM10
Matching Remote
AC00R-1L

NOTES:

- 1) ACI06 and ACM06 have screw terminals, ACM10 has leads
- 2) Matching Remote AC00R-1L has screw terminals

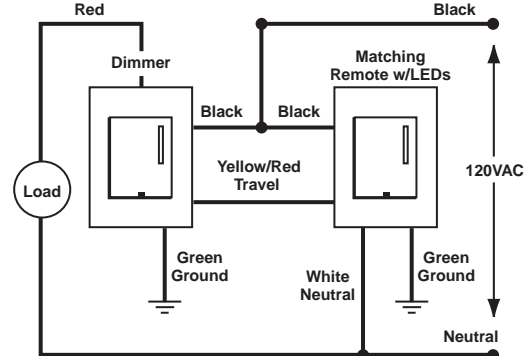

Diagram 7

3-Way wiring for electronic low-voltage dimmer, Mark 10™ *Powerline* dimmer, fan speed control or switch with Matching Remote.

Cat. Nos.
ACS15
Matching Remote
AC0SR-1L

Cat. Nos.
ACE04
ACE06
ACX10
ACF01
Matching Remote
AC00R-1L

NOTE:

Matching Remotes AC0SR-1L and AC00R-1L have screw terminals

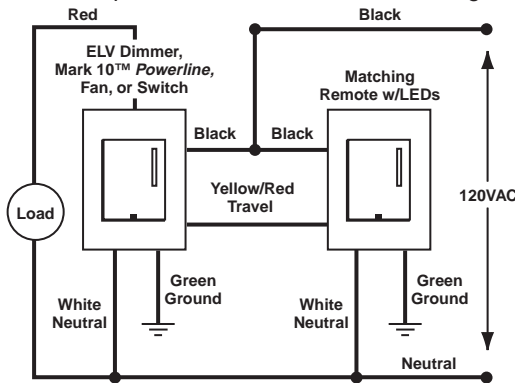

Diagram 8

Single-pole wiring for Hi-lume® fluorescent dimmer

Cat. Nos.
ACH08

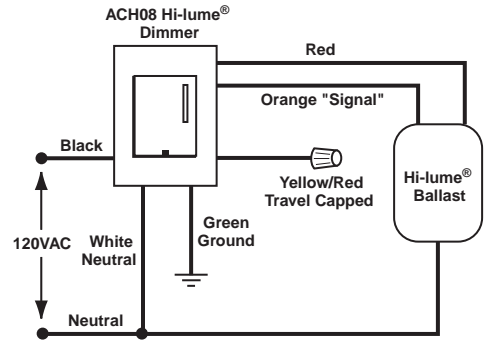

Diagram 9

3-Way wiring for Hi-lume® fluorescent dimmer with Coordinating Remote.

Cat. Nos.
ACH08
Coordinating Remote
AC00R-10

NOTES:

- 1) Coordinating Remote AC00R-10 has screw terminals
- 2) Black and Red terminals on Coordinating Remote are unused

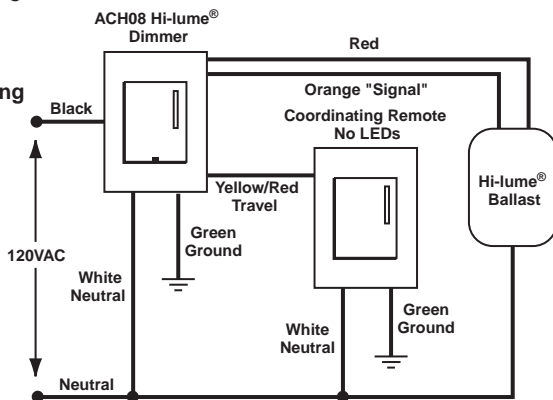
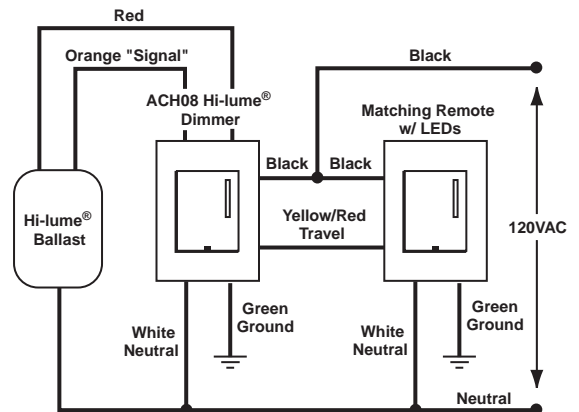

Diagram 10

3-Way wiring for Hi-lume® fluorescent dimmer with Matching Remote.

Cat. Nos.
ACH08
Matching Remote
AC00R-1L

NOTES:
Matching Remote AC00R-1L has screw terminals



WIRING DIAGRAMS

Diagram 11

Single-pole wiring for 20A electromechanical switch

Cat. Nos.
AC201

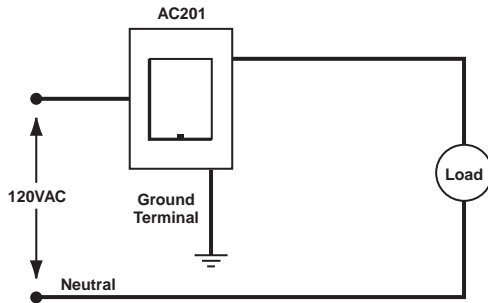

Diagram 12

Triplex Receptacle Wiring

Cat. Nos.
AC315
AC320

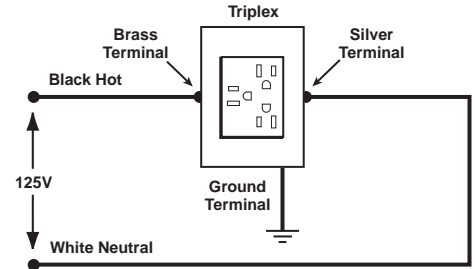

Diagram 13

GFCI Wiring

Cat. Nos.
ACGF1
ACGF2

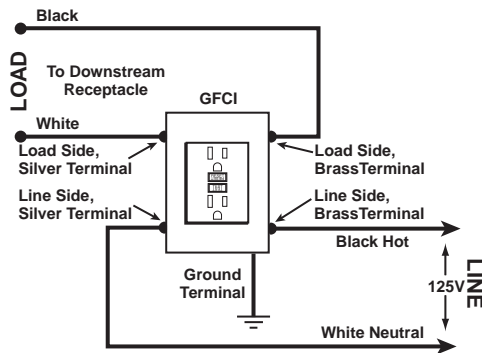
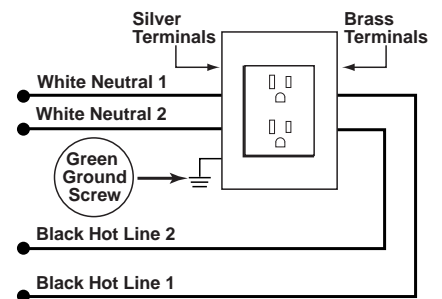
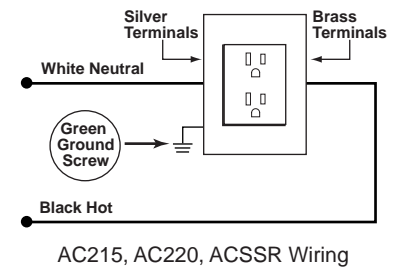

Diagram 14

Duplex Receptacle Wiring

Cat. Nos.
AC215
AC220
ACSSR



AC215, AC220, Alternate Wiring —
Terminal Break-Off Fins removed

PART 1 — GENERAL

1.01 SUMMARY

- A. Section Includes: Acenti-style switches, dimmers, fan speed control (and corresponding remote units), receptacles, wallplates and related devices as specified herein for the areas indicated on the drawings, specifications, and load schedule
- B. Related Sections: Section 16570 (Dimming Controls), Section 16580 (Ballasts)

1.02 REFERENCES

A. Acenti Lighting Controls:

1. UL Standard 1472
2. CSA Standard C22.2 No. 184-M1988
3. IEC Level 4 Surge and Fast Transients
4. California Title 24
5. UL Standard 1472
6. FCC Part 15, Class B for Residential Compliance
7. MIL. STD 105 or ANSI Z1.4
8. UL Listed (File #E-31373)
9. CSA Certified (File #LR-3413)

B. Acenti Switches:

1. UL 20
2. NEMA WD-1 & WD-6
3. CSA Standard C22.1 No. 111
4. UL Listed (File #E-7458)
5. CSA Certified (File #LR-152105)

C. Acenti Receptacles

1. All Receptacles
 - a. NEMA WD-1 & WD-6
 - b. UL 498
 - c. CSA C22.2 No. 42
2. Triplex and Duplex Receptacles
 - a. UL Listed (File #E-13399)
 - b. CSA Certified (File #LR-152105)
3. Surge Protective Receptacles
 - a. UL Listed (File #E-13399)
 - b. CSA Certified (File #MC152105/LR-406)
4. GFCI Receptacles
 - a. UL 943 Class A (File #E-48380)
 - b. CSA Certified (File #LR-57811)

D. Wallplates

1. All wallplates
 - a. UL 514D (File #E-13397)
 - b. CSA C22-2 No. 42.1 (File #152105)
 - c. NEMA WD-1 & WD-6

1.03 SYSTEM DESCRIPTION

- A. Permanently installed, wallbox mounted switches, dimmers and corresponding remote units
- B. Permanently installed, wallbox mounted fan-speed control and corresponding remote units
- C. Permanently installed, wallbox mounted receptacles, including triplex, duplex, surge protective and GFCI
- D. Permanently installed, wallbox mounted voice, data and cable jacks
- E. Screwless, snap-on wallplates

1.04 SUBMITTALS

- A. Submit manufacturer's standard catalog data giving all product, application, wiring, and installation information on all basic components and wallplates. Provide test data and/or samples for finish, color and texture as required to demonstrate conformance with PART 2 of this specification.

1.05 QUALITY ASSURANCE

- A. Manufacturer shall have a minimum of 20 years continuous experience in the manufacture of wallbox-mounted dimming products.

- B. Dimmers, switches and fan-speed control shall be UL Listed and CSA approved specifically for each required load (tungsten, electronic low-voltage ballast, magnetic low-voltage ballast, Mark 10™ *Powerline* fluorescent, and Hi-lume® fluorescent). Manufacturer shall provide file card or certificate upon request. Universal load-type dimmers shall not be acceptable.
- C. Source Limitations: To assure compatibility, all dimming controls shall be obtained from a single source with complete responsibility over all lighting controls, including accessory products. The use of subcontracted component assemblers is not acceptable.
- D. Manufacturer shall be ISO 9001 certified and provide a copy of the certificate upon request.

1.06 WARRANTY

- A. Manufacturer's Warranty: All equipment shall be warranted free of defects in materials and workmanship.
1. Warranty Period: Five years from date of purchase
 2. Owner Rights: Manufacturer's warranty is in addition to, not a limitation of, other rights the Owner may have under contract documents.

PART 2 — PRODUCTS

2.01 ACCEPTABLE MANUFACTURERS

- A. Leviton Manufacturing Co., Inc.
- B. Unless otherwise noted, all basic components (dimmer, fan-speed control, switch and corresponding remote units; receptacle; voice, data and cable jack; and wallplates) shall be provided by one manufacturer.

2.02 EQUIPMENT

A. Leviton Acenti Lighting Controls

1. Performance

- a. Controls shall provide full-range, continuously variable control of light intensity.
- b. Dimmers requires 40W minimum load.
- c. Controls shall fit in the Acenti wallplate opening only. Controls shall be thin profile with no exposed heat sink/yoke and shall fit in a single-gang 18 cubic-inch wallbox. All controls shall have a matte finish.
- d. Controls shall provide a blue LED Locator light that shall illuminate when the lights are OFF to help users locate control in the dark.
- e. Controls shall provide a Dim/Bright bar that allows light level (or fan speed) to be set by the user. A five-step blue LED indicator shall be integrated in the Dim/Bright bar to show relative lighting level. Push Pad with return-to-neutral design shall provide preset ON/OFF control independent of Dim/Bright bar.
- f. Push Pad and Dim/Bright bar shall be ergonomically designed for precise tactile quality with distinct actuation confirmation.
- g. Controls shall provide a default setting where Push Pad preset ON switching returns lights to last selected level when lights were ON.
- h. Controls shall provide a Dim Lock feature that allows users to program a customized preset ON level. With Dim Lock active, lights shall switch ON to selected preset level regardless of last established light level (Default setting is with Dim Lock OFF; it shall be activated by user if desired).
- i. Controls shall provide a selectable fade rate for ON and OFF switching. Default setting shall be 1.5 seconds for ON and 3.0 seconds for OFF.
- j. Controls shall provide a 10 second delay-OFF from ON when Push Pad is pressed and held.
- k. Controls shall provide switching from OFF to maximum brightness when Push Pad is pressed and held.

- l. Controls shall provide the ability to change the selected brightness level by pressing the Dim/Bright bar while the lights are OFF. LED display shall show selected level and lights shall not be turned ON.
 - m. Controls shall provide intuitive “house guest” feature allowing lights to be dimmed to OFF by pressing and holding the Dim/Bright bar. Preset level shall not be changed.
 - n. Controls shall provide an adjustable minimum brightness setting to accommodate lighting loads with a minimum turn-on voltage.
 - o. Programmable settings for Dim Lock preset level, minimum brightness level and fade rate shall not require tools or wallplate removal.
 - p. Controls shall provide single-pole, 3-way, or multi-location control with choice of remote dimmers.
 - q. Matching Remote AC00R-1L shall provide blue LED Locator and LED Brightness display and shall provide 3-way or up to 5 location control. Matching Remote shall require neutral connection.
 - r. Coordinating Remote AC00R-10 shall provide 3-way or up to 10 location control. Coordinating Remote shall require neutral connection in specific applications.
 - s. Controls shall provide air gap switch to totally disconnect power from load during OFF condition. Air gap switch shall be concealed during normal operation and shall be accessible without removing wallplate.
 - t. Within rated capacity, dimmers shall be available for direct control of incandescent, electronic low-voltage, magnetic low-voltage, Mark 10™ *Powerline* fluorescent, and Hi-lume® or Eco-10™ (Eco-Series) fluorescent. Matching fan-speed control and switches shall also be available.
 - u. Controls shall not require the removal of fins in multi-gang installations. Controls shall be derated in multi-gang installations in accordance with manufacturer’s specifications.
 - v. All Controls shall have a clear polycarbonate base.
 - w. Controls shall provide transient surge protection to IEC Level 4.
 - x. Controls shall provide ESD protection to IEC 1000 4-2 Level 4 to protect against damage and memory loss due to static discharges.
 - y. Dimmers shall provide RFI filtering for radio, audio, and video equipment.
 - z. Controls shall incorporate power-failure memory. Should power be interrupted and subsequently returned, the lights or fans will come back on to the same levels set prior to the power interruption.
 - aa. Controls shall operate in an ambient temperature range of 0°C (32°F) to 55°C (131°F).
- 2. Incandescent Dimmers**
- a. Dimmers shall have a maximum output of no less than 95% of line voltage.
 - b. ACI06 shall provide 4 terminal screws for Line, Load, Remote and Ground.
 - c. ACM10 rated for 1000W incandescent shall provide 4 wire leads for Line, Load, Remote and Ground.
- 3. Electronic Low-Voltage (ELV) Dimmers**
- a. Dimmers shall contain circuitry specifically designed to control the input of electronic (solid state) low-voltage transformers. Dimmers using standard phase control shall not be acceptable.
 - b. ACE04 (400W) and ACE06 (600W) dimmers shall have a resettable overload protection that automatically shuts off when dimmer capacity is exceeded.
 - c. Dimmers shall provide 5 wire leads for Line, Load, Neutral, Remote and Ground.
- 4. Magnetic Low-Voltage (MLV) Dimmer**
- a. ACM10 shall provide direct control of up to 1000VA of 120V magnetic low-voltage load.
- b. Dimmer shall contain circuitry specifically designed to control and provide a symmetrical AC waveform to the input of magnetic low voltage transformers per UL 1472 section 5.11.
 - c. Dimmer shall not cause a magnetic low voltage transformer to operate above the transformers rated operating current or temperature.
 - d. Dimmers shall have a maximum output of no less than 95% of line voltage.
 - e. Dimmer shall provide 4 wire leads for Line, Load, Remote and Ground.
- 5. Fluorescent Dimmers**
- a. Fluorescent dimmers shall provide direct control of fluorescent dimming ballasts up to the manufacturer’s specified rating.
 - b. ACX10 shall be rated 1000VA to control Mark 10™ *Powerline* or Tu-Wire™ ballasts and provides 5 wire leads for Line, Load, Neutral, Remote and Ground.
 - c. ACH08 shall be rated 8A to control Hi-lume® or Eco-10™ (Eco-Series) ballasts and provides 6 wire leads for Line, Load, Neutral, Signal, Remote and Ground.
- 6. Fan-Speed Control**
- a. ACF01 Quiet Fan-Speed Control shall be rated 1.5A and provide Low-Medium-High speed settings plus OFF.
 - b. ACF01 shall provide microprocessor-controlled “kick-start” to allow fan to go directly from OFF to any speed setting.
 - c. ACF01 shall provide 5 wire leads for Line, Load, Neutral, Remote and Ground.
- 7. Switches**
- a. All switches shall be completely compatible with Acenti lighting controls and provide ON/OFF Push Pad ergonomically designed for precise tactile quality with distinct actuation confirmation.
 - b. All switches shall provide a blue LED locator light that shall illuminate when the lights are OFF to help users locate control in the dark.
 - c. ACS15 electronic switch shall be rated 15A 120V AC and provide 5 screw terminals for Line, Load, Neutral, Remote and Ground.
 - d. ACS15 electronic switch shall provide single-pole, 3-way, or multi-location control with choice of remote dimmers.
 - e. Matching Remote Switch AC0SR-1L shall provide blue LED locator and shall provide 3-way or up to 5 location control. Matching Remote shall require neutral connection.
 - f. Coordinating Remote Switch AC0SR-10 shall provide 3-way or up to 10 location control. Coordinating Remote shall require neutral connection.
 - g. AC201 electromechanical switch shall be single-pole only and rated 20A 120V AC with 3 screw terminals for Line, Load and Ground.
- B. Acenti Receptacles**
1. All Leviton Acenti Receptacles shall be designed to perfectly coordinate with Leviton Acenti Switches and Lighting Controls.
 2. Acenti Triplex Receptacle shall provide unique space-saving convenience by accepting three grounding plugs. AC315 Triplex shall be rated 15A-125V (NEMA 5-15R), AC320 Triplex rated 20A-125V (NEMA 5-20R).
 3. Acenti Triplex Receptacles shall fit into standard size single-gang wallbox.
 4. Acenti Duplex Receptacles shall also be available.
 5. ACSSR Acenti Duplex Surge Receptacle (15A-125V NEMA 5-15R) shall provide point-of-use surge protection for sensitive electronic equipment.
 - a. Blue monitor/indicator light shall coordinate with all Acenti blue LEDs and provide surge protection status at a glance.
 - b. Audible tone alert shall sound if surge protection is lost.
 - c. Surge Receptacle shall provide eight back-wire holes (two for each line and load connection) and ground terminal for easy installation.

- d. Receptacle shall provide UL 1449 clamping level of 400V peak for all modes and a maximum single-pulse surge current rating of 26kA (Line-Neutral) and 13kA for (Line-Ground) and (Neutral-Ground).
- 6. ACGF1 (15A) and ACGF2 (20A) Acenti GFCI Receptacles shall provide advanced ground fault protection with patented lockout-action
 - a. GFCI RESET action shall be blocked if ground fault protection has been compromised, reducing the possibility of end-users incorrectly assuming that a reset GFCI is providing protection when it is not.
 - b. Advanced "dead-face" safety design shall block power at the GFCI receptacle face and at all downstream-connected receptacles if the GFCI is improperly wired with a line-load reversal. The GFCI cannot be reset unless it is correctly wired from the line side.
 - c. GFCI shall not be reset if neutral is not present. The GFCI shall be able to be tripped with TEST button under this condition.
 - d. GFCI shall provide eight back-wire holes (two for each line and load connection) and one back-wire ground terminal for easy installation.
 - e. All GFCIs shall conform to UL 943 Class A GFCI requirements for trip time and resistance to electrical surges and over-voltages.
- 7. Acenti QuickPort® Wallplate Inserts shall provide multimedia connections.
 - a. Inserts shall allow use of Leviton snap-in QuickPort connectors for data, audio and video connections.
 - b. Inserts shall be available in 2-, 3-, 4- and 6-port configurations.
 - c. Leviton QuickPort connectors shall be FCC Part 68 compliant and designed for mating with 4- or 6-conductor phone jacks, Cat 5 rated jacks, coax connectors and other types of multimedia connections.

C. Acenti Wallplates

- 1. Plastic wallplates shall be manufactured from engineering-grade polymer to provide matte finish and color consistency with all Acenti devices.
- 2. Wallplates shall be screwless, snap-on design that completes the distinct geometry of the Acenti installation.
- 3. Multi-gang wallplates shall provide a frameless design.
- 4. All Acenti wallplates shall include a steel alignment plate that uses locating pins to form a "positioning nest" for the Acenti device.
- 5. Wallplate shall accommodate irregular wall surfaces and ensure a precise wallplate/device alignment in every installation.
- 6. Wallplates shall be available with a brushed stainless steel finish to complement designer-style appliances.

D. Standard Features

- 1. Acenti devices shall feature multi-function self-grounding clip
- 2. Mounting clips shall grip alignment pins to ensure precise wallplate/device alignment.
- 3. Mounting clips shall provide self-grounding for Acenti device when used with a properly grounded metal wallbox.
- 4. Mounting clips shall have contoured legs to provide superior holding power for all Acenti screwless, snap-on wallplates.
- 5. Mounting clips shall be attached to device mounting strap using TOX® fastening system. Fastening with conventional spot-welding or riveting is not acceptable.

2.03 SOURCE QUALITY CONTROL

- A. All dimming controls shall be 100% function tested at the time of manufacture. Statistical sampling plan shall not be acceptable.

PART 3 — EXECUTION

3.01 INSTALLATION

- A. Contractor shall furnish all devices (dimmers, switches, receptacles & wallplate kits), labor and other services necessary for the proper installation of the devices as indicated on the drawings and specified herein.
- B. Contractor shall be responsible for derating lighting control capacity in multi-gang installations.
- C. Devices shall be installed utilizing manufacturer's recommended application, wiring and installation instructions.
- D. Contractor shall provide frameless wallplate covers per specification 2.02 for all devices ganged in a common box. Contractor shall provide barriers within the box where required by code.

3.02 FIELD QUALITY CONTROL

- A. Leviton technical hotline available 8:30AM–7:30PM E.S.T. Monday–Friday: 1-888-4-ACENTI
- B. Supplemental information shall be provided by Leviton's website at www.leviton.com/acenti

TOX® is a registered trademark of TOX PRESSOTECHNIK-L.L.C.
 Tu-Wire™ and Eco-10™ (Eco-Series) are trademarks and Hi-Lume® is a registered trademark of Lutron Electronics, Inc.
 Mark 10® Powerline is a registered trademark of Advance Transformer



Leviton Manufacturing Co., Inc.

59-25 Little Neck Parkway, Little Neck NY 11362-2591
 Customer Service: 1-888-4-ACENTI • FAX: 1-800-832-9538

Leviton Manufacturing of Canada, Ltd.

165 Hymus Boulevard, Pointe Claire, Quebec H9R 1E9
 Customer Service: 1-800-469-7890 • FAX: 1-800-563-1853

Visit Leviton's Website at www.leviton.com/acenti

© 2004 Leviton Manufacturing Co., Inc. All rights including Trade Dress Rights Reserved. U.S. & Foreign Patents Pending Acenti is a trademark and QuickPort is a registered trademark of the Leviton Manufacturing Co., Inc. B-1023/H4-5M rs

