

## For Medium Bi-Pin Lamps — Turn-Type

DESCRIPTION	CAT. NO.	RATING
Low Profile, Slide-On, with Captive Nut	13353-N	660W 600V
Tall Profile, Slide-On, with Captive Nut	13357-N	660W 600V
Tall Profile without Side Grooves, Slide-On, with Captive Nut	13359-N	660W 600V
Low Profile Disconnect, Slide-On	13351-D	660W 600V
Tall Profile Disconnect, Slide-On	13354-D	660W 600V
Low-Profile; Shunted, Slide-On	23351	660W 600V

## For Medium Bi-Pin Lamps — Straight-In

DESCRIPTION	CAT. NO.	RATING
Low Profile, Slide-On	13150-UR5	660W 600V
Self-Locking; Slide-In, with Captive Nut. For use with T-8 Lamps	13451-N	660W 600V

## For Medium Bi-Pin Lamps — Snap-In/Slide-On Design and Lamp-Lock

DESCRIPTION	CAT. NO.	RATING
Snap-In or Slide-On Mounting Featuring Lamp-Lock, with Panel Locator Post. For T-8 and T-12 Lamps	13653-WP	660W 600V
Same as Above, Less Locator Post	13653-NP	660W 600V
Same as 13653-WP, Except with Internal Shunt Connection for Electronic Ballasts	23653-WP	660W 600V
Same as Above, Less Locator Post	23653-NP	660W 600V
Snap-In or Slide-On Mounting Featuring Lamp-Lock, Optional Panel Locator Post. Dedicated for Energy-Efficient T-8 Lamps Only	13652-WP	660W 600V
Same as 13652, Except with Internal Shunt Connection for Electronic Ballasts	23652-WP	660W 600V

All devices are UL Listed and CSA Certified.

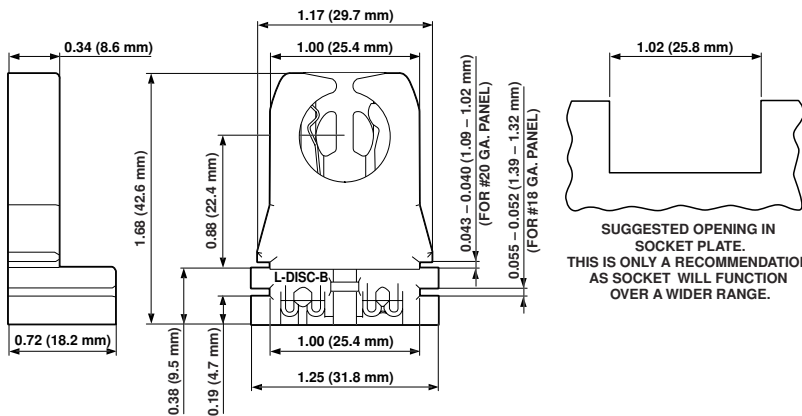

Cat No. 13351-D

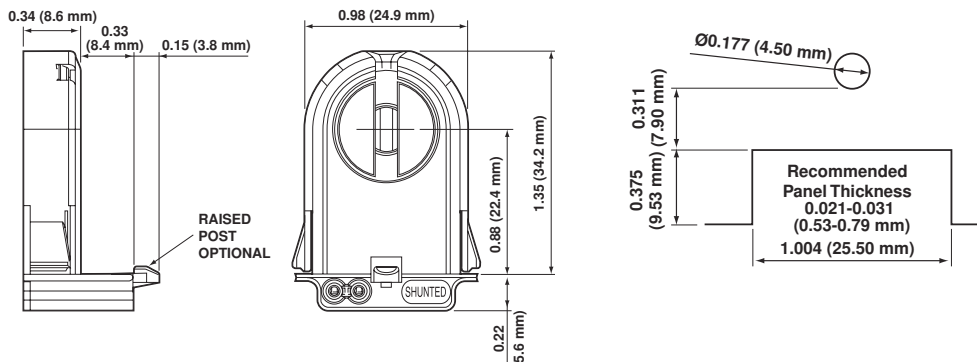

Cat No. 23653-WP

## SPECIFICATIONS & FEATURES

### Lamp-Lock

- Four-position lamp-lock socket rotates 90°, forward and back, for quick relamping
- Lamp-Lock models have slim, low profile silhouette that fits 22 to 25 gauge panels
- Chemical-resistant white thermoplastic body

## TESTING & CODE COMPLIANCE

- UL Listed (File #E-5833)
- CSA Certified (File #LR-1863; LR-5863; LR-2200)
- NOM Certified (#057)