

Oval Entry 6P6C RJ-11 Plug (Solid Wires)

PRODUCT SPECIFICATION



Package includes:

A. Oval Entry 6P6C Plug, 100 pcs

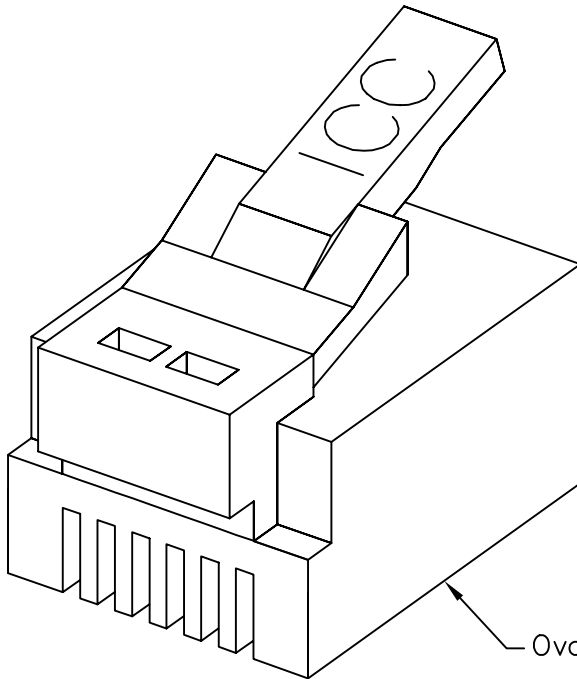

Oval Entry 6P6C Plug

Features and Benefits:

- Designed for 6-position 6-conductor, solid wires, round line cord entry
- Ideal for customization of cords for voice or other low speed transmission applications
- Accepts 28~24 AWG solid wires
- Used with ICACSCT460 or ICACSCT860 crimping tool
- UL listed

PLUG, 6P6C, OVAL ENTRY, SOLID, 100 PK

ITEM NO.	ICMP6P6SRD	REV.	B	
DWG NO.	PSMP6P6SRD	PAGE NO.	1	

CUSTOMER CARE / TECHNICAL SUPPORT * CSR@ICC.COM / 888-ASK-4-ICC (275-4422) * 14700 Alondra Blvd., La Mirada, CA 90638 * www.icc.com

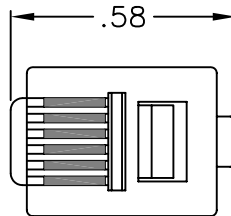
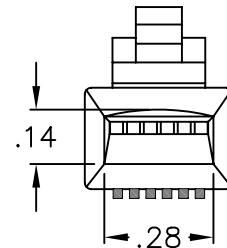
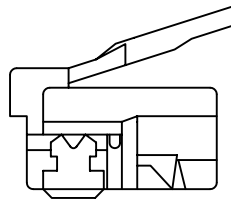
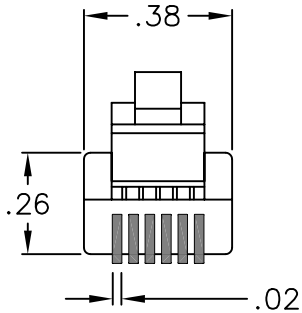
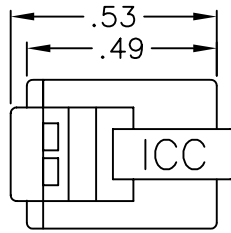

NOTE: UNLESS OTHERWISE SPECIFIED

1. ELECTRICAL:

- A. CURRENT/VOLTAGE RATING: 1.5 AMPS / 30 VAC 42 VDC
- B. DIELECTRIC WITHSTANDING VOLTAGE: 1000 VOLTS RMS, 1 MIN (60 Hz)
- C. INSULATION RESISTANCE: 500 MOHMS MIN
- D. TERMINATION RESISTANCE: 35 MILLIOHMS MAX AFTER ENVIRONMENTAL TESTING

2. MATERIAL & FINISH:

- A. HOUSING: PC, UL 94V-2
- B. COLOR: CLEAR
- C. CONTACT: PHOSPHOR BRONZE, GOLD PLATING OVER 100 MICRO INCH NICKEL
- D. GOLD PLATING: 1.27 MICRON/50 MICRO INCH MIN

PLUG, 6P6C, OVAL ENTRY, SOLID, 100 PK		 PremiumProducts ProvenPerformance CompetitivePrices	
ITEM NO.	ICMP6P6SRD		REV. B
DWG NO.	PSMP6P6SRD		PAGE NO. 2