



## SPECIFICATIONS & FEATURES

- V-0-MAX™ Locking Receptacles carry a UL 94 V-0 Flammability Rating, the best rating of any material used in Industrial Locking Flush Receptacle available today
- Locking Plugs and Connectors feature heavy-duty construction for top performance in the environmental extremes of grueling industrial settings
- Flanged Inlets and Outlets are built to endure hard use with rugged nylon flanges that assure a smooth, flush fit and outstanding resistance to cracking and breaking

## TESTING & CODE COMPLIANCE

- All receptacles, plugs, connectors, inlets and outlets are designed to meet NEMA WD-6, and ANSI C-73, and to meet/exceed UL 498 standards
- UL Fed. Spec. Listed WC-596 (File #13399 – Cat. Nos. 2670, 2676, 2680, 2686, 2690, 2696 2710, 2716; File #E-13393 – Cat. Nos., 2671, 2673, 2675, 2681, 2683, 2685, 2691, 2693, 2695, 2711, 2713, 2715)
- CSA Certified (File #LR-406)
- NOM Certified (File #057)
- Backed by a Lifetime Warranty

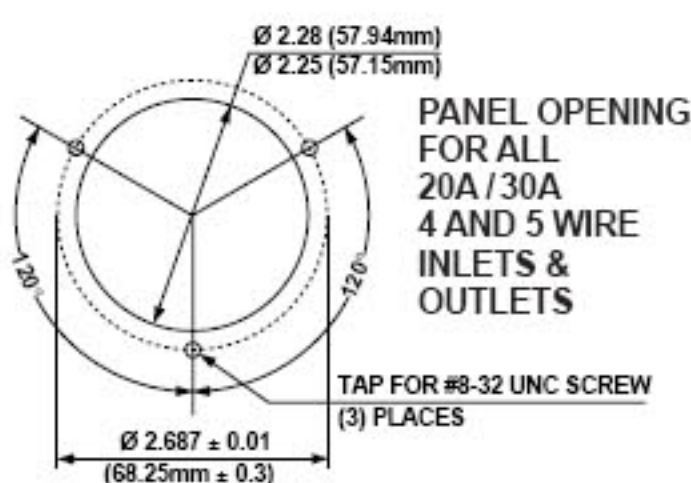

## MATERIAL CHARACTERISTICS

Environmental: Flammability per UL94 or CSA C22/06 Requirements  
Operating Temperature: -40°C to 60°C





## 30 AMP Locking Devices



### 30 AMP 3Ø 250V 3-Pole 3-Wire Non-Grounding

DESCRIPTION	CAT. NO.	CORD DIA. (inches)	WIRE GAUGE (stranded)	NEMA CONFIG.
Single Flush Receptacle★	2670†			
Locking Plug, Black Nylon Body★	2671	.385-.860	10-18	L11-30R 
Locking Connector, Black Nylon Body★	2673	.385-.860	10-18	
Locking Flanged Inlet★	2675			L11-30P 
Locking Flanged Outlet★	2676			



### 30 AMP 3Ø 480V 3-Pole 3-Wire Non-Grounding

DESCRIPTION	CAT. NO.	CORD DIA. (inches)	WIRE GAUGE (stranded)	NEMA CONFIG.
Single Flush Receptacle★	2680†			
Locking Plug, Black Nylon Body★	2681	.385-.860	10-18	L12-30R 
Locking Connector, Black Nylon Body★	2683	.385-.860	10-18	
Locking Flanged Inlet★	2685			L12-30P 
Locking Flanged Outlet★	2686			

### 30 AMP 3Ø 600V 3-Pole 3-Wire Non-Grounding

DESCRIPTION	CAT. NO.	CORD DIA. (inches)	WIRE GAUGE (stranded)	NEMA CONFIG.
Single Flush Receptacle★	2690†			
Locking Plug, Black Nylon Body★	2691	.385-.860	10-18	L13-30R 
Locking Connector, Black Nylon Body★	2693	.385-.860	10-18	
Locking Flanged Inlet★	2695			L13-30P 
Locking Flanged Outlet★	2696			

### 30 AMP 125/250V 3-Pole 4-Wire Grounding

DESCRIPTION	CAT. NO.	CORD DIA. (inches)	WIRE GAUGE (stranded)	NEMA CONFIG.
V-0-MAX™ Single Flush Receptacle	2710†			
V-0-MAX™ Single Flush Receptacle, Isolated Ground	2710-IG†			
Locking Plug, Black Nylon Body	2711	.595-1.150	10-18	L14-30R 
Locking Plug, Yellow Nylon Body	2711-CY	.595-1.150	10-18	
Locking Connector, Black Nylon Body	2713	.595-1.150	10-18	L14-30P 
Locking Connector, Yellow Nylon Body	2713-CY	.595-1.150	10-18	
Locking Flanged Inlet	2715			
Locking Flanged Outlet	2716			

†Uses stainless steel wallplate, Cat. No. 84020-40. For additional wallplate selections, please see Section G.  
For Corrosion Resistant Locking Devices, please check pages K2-K5  
Weather-Resistant Boots for 30A Locking Plugs and Connectors are listed on page J20  
All devices are UL Listed. Also CSA certified except where indicated by ★

