





















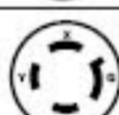

Wetguard™ Wetguard™ Devices Engineered to IP66 & IP67 Watertight Standards

Wetguard™ Locking Plugs and Connectors

DESCRIPTION	CAT. NO. PLUG	CAT. NO. CONNECTOR
High-Visibility Yellow, 30A-125V 2-Pole, 3-Wire	28W47 L5-30P 	29W47 L5-30R 
Black, 30A-125V 2-Pole, 3-Wire	28W47-B L5-30P 	29W47-B L5-30R 
High-Visibility Yellow, 30A-250V 2-Pole, 3-Wire	28W48 L6-30P 	29W48 L6-30R 
High-Visibility Yellow, 30A-277V 2-Pole, 3-Wire	28W49 L7-30P 	29W49 L7-30R 
High-Visibility Yellow, 30A-125/250V 3-Pole, 4-Wire	28W74 L14-30P 	29W74 L14-30R 
High-Visibility Yellow, 30A-3Ø 250V 3-Pole, 4-Wire	28W75 L15-30P 	29W75 L15-30R 
High-Visibility Yellow, 30A-3Ø 480V 3-Pole, 4-Wire	28W76 L16-30P 	29W76 L16-30R 
High-Visibility Yellow, 30A-3Ø 600V 3-Pole, 4-Wire	28W77 L17-30P 	29W77 L17-30R 
High-Visibility Yellow, 30A-3ØY 120/208V 4-Pole, 5-Wire	28W81 L21-30P 	29W81 L21-30R 
High-Visibility Yellow, 30A-3ØY 277/480V 4-Pole, 5-Wire	28W82 L22-30P 	29W82 L22-30R 
High-Visibility Yellow, 30A-3ØY 347/600V 4-Pole, 5-Wire	28W83 L23-30P 	29W83 L23-30R 



Wetguard™ Non-NEMA, Non-Grounding Devices (For Replacement Use Only)

DESCRIPTION	CAT. NO. PLUG	CAT. NO. CONNECTOR
High-Visibility Yellow, 30A-125/250V 3-Pole, 3-Wire★	28W08 NON-NEMA 	29W08 NON-NEMA 
High-Visibility Yellow, 30A-3ØY 120/208V 4-Pole, 4-Wire★	28W09 NON-NEMA 	29W09 NON-NEMA 

Replacement Closure Cap

DESCRIPTION	CAT. NO.
Replacement Connector Closure Cap for 30A devices	50W54

All locking devices are UL Listed. Also CSA certified except where indicated by★

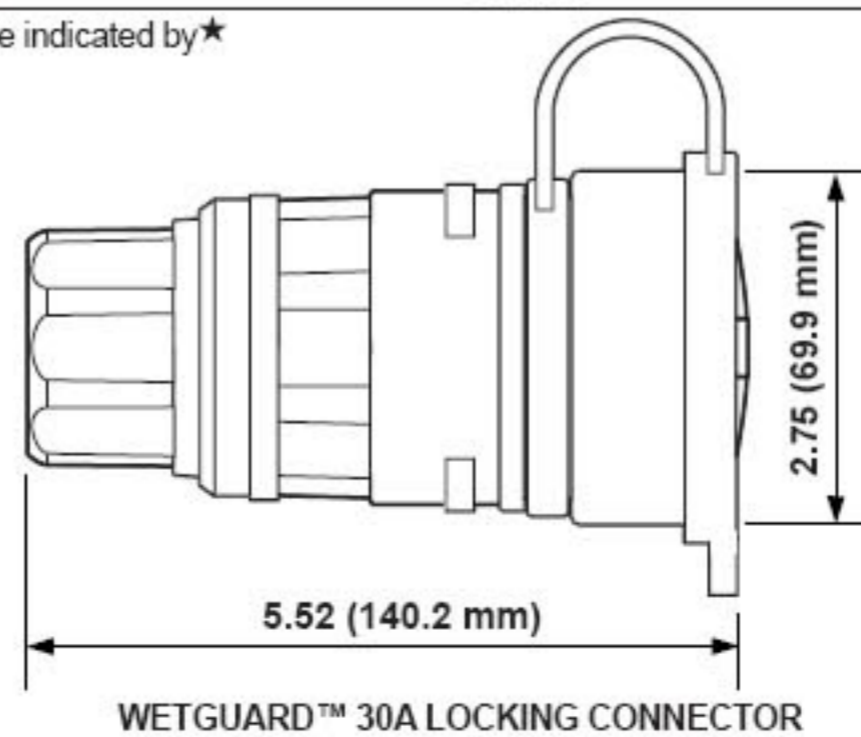
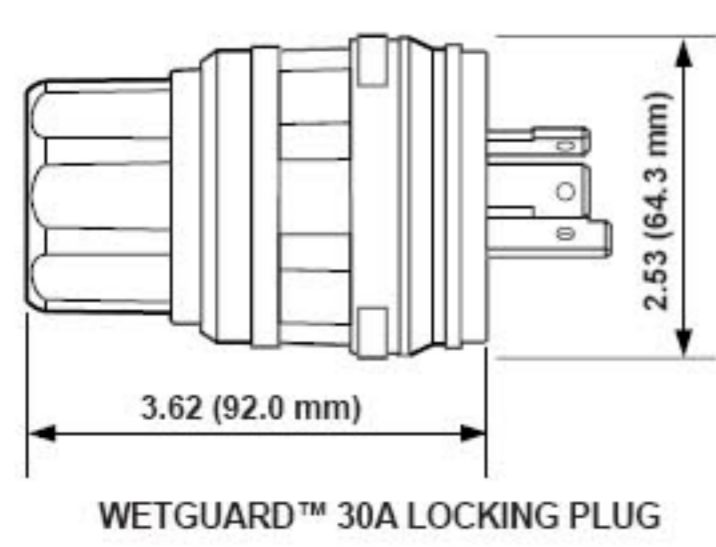

SPECIFICATIONS & FEATURES

- Wetguard**
- IEC IP66 and IP 67 Rated, in accordance with IEC 529 as evaluated by UL and CSA
 - NEMA Type 4, 4X, 6 and 6P Ratings in accordance with UL 50 and CSA 94
 - Outstanding resistance to wet and damp environments, extreme temperature variations, acids, alkalis, grease, oils and solvents
 - Effective "tongue and groove" construction seals out water, moisture, dirt when plugs are mated with connectors
 - Innovative strain-relief grips cables securely, keeps out water and moisture
 - Cord clamp range for 30A devices: 12/3-8/5 SO, ST, SJ (.625"-1.125")
 - Non-magnetic stainless steel fast-threading assembly screws won't interfere with sensitive equipment
 - Connector "hood" closure cap seals device when not in use

TESTING & CODE COMPLIANCE

- Meet NEMA WD 1 & 6, ANSI requirements
- UL Listed & meets Fed. Spec. requirements: (File #13393)
- CSA Certified (File #LR-406)
- NOM Certified (#057)
- Backed by a Lifetime Warranty

MATERIAL CHARACTERISTICS

Environmental: Flammability, Rated V2
Operating Temperature: -40°C to 60°C