



Middle Atlantic Products, Inc.

middleatlantic.com

PTRK Series Portable Racks

EIA/TIA Compliant

Secure rolling steel rack serves a variety of applications

Features

- Fully welded 16-gauge construction
- 1/8" thick structural steel internal braces
- Smooth-rolling 4" locking cushion casters
- Available with solid locking front door, or with graphite laminate top and plexi front door
- Removable Decora® plate for low voltage Decora® accessories
- Standard keylocked front & rear doors
- Rubber-padded spring loaded recessed handles
- Infinitely adjustable 10-32 threaded 11-gauge rackrail
- 500 lb. weight capacity
- Durable textured black powder coat finish



PTRK-14MDK (shown with optional LCD mount)



PTRK-21

Comes standard with wood top and plexi front door as shown

PORTABLE RACK ACCESSORIES
REAR RACKRAIL
LATCH
DOCUMENT POCKET

Architects' and Engineers' Specifications

EIA compliant 19" equipment rack shall be Middle Atlantic Products model # PTRK-__ / PTRK-__ MDK (refer to chart). Overall dimensions of rack shall be __" H x 22.63" W x __ D (refer to chart). Useable height shall be __ rackspaces (refer to chart). Rack shall have a 500 lb. weight capacity. Rack shall be of fully welded construction. Top, bottom and sides of PTRK-__ (refer to chart) shall be 16-gauge steel, front and rear door shall be 18-gauge steel. Removable Decora® plate on the front, top of rack shall accept any low voltage Decora® accessory. Additionally PTRK-__ MDK shall include graphite laminate wood top, plexi front door and solid rear door. All structural elements shall be finished in a black powder coat. Rackrail shall be constructed of 11-gauge steel with tapped 10-32 mounting holes in universal EIA spacing with black e-coat finish and numbered rackspaces. Rack shall come equipped with smooth rolling 4" locking cushion casters and solid front and rear doors standard. Rack shall be warrantied to be free from defects in material or workmanship under normal use and conditions for the lifetime of the product.

OPTIONS

- Rear rackrail 10-32 threaded 11-gauge, in universal EIA spacing. Part # PTRK-RRxx (x= # of rack spaces required)
- Single LCD monitor mount accommodates VESA 75 and VESA 100 monitor shall be Middle Atlantic Products part # LD-AM1X1
- UCP panel knockouts accommodate commonly used connectors, see middleatlantic.com for details

TEMP-DEC / LT-DEC

- Retractable Decora® mount LED illuminates components as needed, model # LT-DEC
- Digital Decora® mount temperature display monitors internal enclosure temperature, model # TEMP-DEC

customizable specification clips available at middleatlantic.com

Engineered Mounting Solutions

US: New Jersey • California • Illinois • Voice: 973-839-1011 Fax: 973-839-1976 • middleatlantic.com
Canada: Ontario • British Columbia • Voice: 613-836-2501 Fax: 613-836-2690 • middleatlantic.ca

Sold by:



PTRK basic dimensions

All dimensions in inches unless otherwise noted [All dimensions in brackets are in millimeters]

standard worksurface for (PTRK-14MDK/PTRK-1426MDK and PTRK-21MDK/PTRK-2126MDK only) with grommet for LCD mount and cable pass through

Fully adjustable threaded 10-32 rackrail front door clearance with rackrail in forward most position = 1.25 [32]

1.00 [25] dia. x 2.50 [64] KO 5/8 single

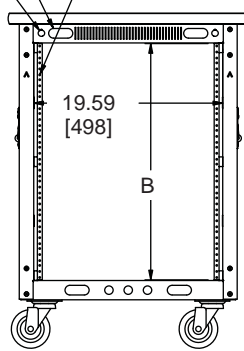

PTRK-XXMDK REAR VIEW
(with wood top shown and doors removed to show rackrail)

TOP VIEW PTRK-XXMDK

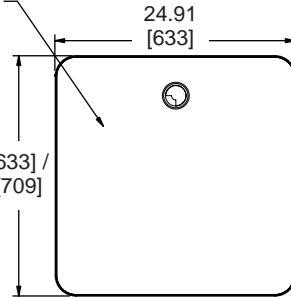

Middle Atlantic Products UCP Series Universal Connector Panel single panel knockout

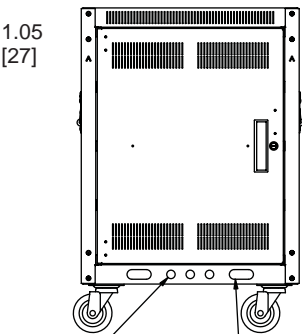

PTRK-XX REAR VIEW
(without wood top)

TOP VIEW PTRK-XX

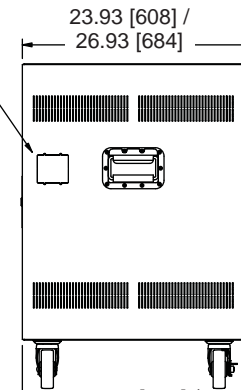
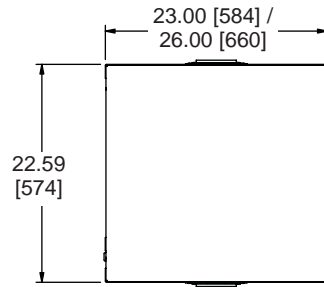

SIDE VIEW

TOP SECTIONAL VIEW OF PTRK SIDE

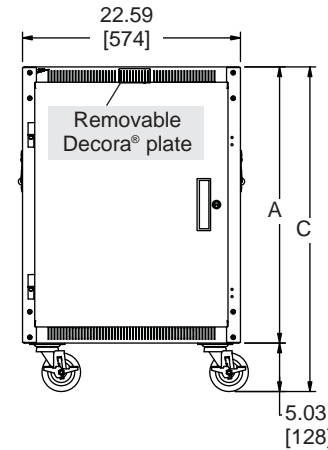
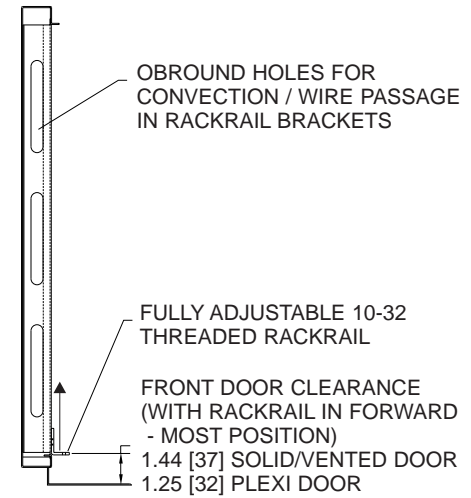

FRONT VIEW

PART #	A RACK HEIGHT WITHOUT CASTERS	B USEABLE HEIGHT	C OVERALL HEIGHT	USEABLE DEPTH	OVERALL DEPTH	FRONT DOOR
PTRK-14	28.80 [731]	24.50 [622] (14 rackspace)	33.83 [859]	21.50 [546]	23.93 [608]	solid
PTRK-21	40.87 [1038]	36.75 [933] (21 rackspace)	45.91 [1166]	21.50 [546]	23.93 [608]	solid
PTRK-14MDK	29.67 [754]	24.50 [622] (14 rackspace)	34.71 [882]	21.50 [546]	24.91 [633]	plexi
PTRK-21MDK	41.92 [1065]	36.75 [933] (21 rackspace)	46.95 [1193]	21.50 [546]	24.91 [633]	plexi
PTRK-1426	28.80 [731]	24.50 [622] (14 rackspace)	33.83 [859]	24.50 [622]	26.93 [684]	solid
PTRK-2126	40.87 [1038]	36.75 [933] (21 rackspace)	45.91 [1166]	24.50 [622]	26.93 [684]	solid
PTRK-2726	51.37 [1305]	47.25 [1200] (27 rackspace)	56.41 [1433]	24.50 [622]	26.93 [684]	solid
PTRK-1426MDK	29.67 [754]	24.50 [622] (14 rackspace)	34.71 [882]	24.50 [622]	27.91 [709]	plexi
PTRK-2126MDK	41.92 [1065]	36.75 [933] (21 rackspace)	46.95 [1193]	24.50 [622]	27.91 [709]	plexi
PTRK-2726MDK	52.42 [1331]	47.25 [1200] (27 rackspace)	57.45 [1459]	24.50 [622]	27.91 [709]	plexi

