













Integrated Power Inlets and Outlets with Weather-Resistant Covers

- Engineered to IP 64 and NEMA 3R Protection Ratings
- Suitable for Industrial Indoor and Outdoor Use

Integrated Power Inlets and Outlets with Weather-Resistant Covers
Gray, Glass-Filled Thermoplastic Cover and White, Nylon Device

DESCRIPTION	CAT. NO. FLANGED INLET	CAT. NO. FLANGED OUTLET
Standard Wire Wells, 15A-125V 2-Pole, 3-Wire	5278-CWP NEMA 5-15P 	5279-CWP NEMA 5-15R 
Slots for Fork Terminals, 15A-125V 2-Pole, 3-Wire	5278-FWP NEMA 5-15P 	5279-FWP NEMA 5-15R 
Standard Wire Wells, 15A-250V 2-Pole, 3-Wire	15678-CWP NEMA 6-15P 	15679-CWP NEMA 6-15R 
Standard Wire Wells, 20A-125V 2-Pole, 3-Wire	15378-CWP NEMA 5-20P 	15379-CWP NEMA 5-20R  CSA config. in Canada 
Standard Wire Wells, 20A-250V 2-Pole, 3-Wire	5478-CWP NEMA 6-20P 	5479-CWP NEMA 6-20R  CSA config. in Canada 

All devices are UL Listed and CSA Certified.
Note: For locking configurations, please see Section J.

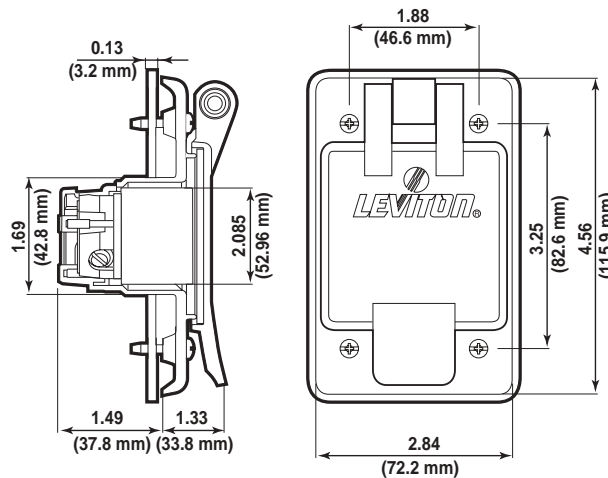

Cat. No. 5279-CWP, -FWP

SPECIFICATIONS & FEATURES

- Glass-filled thermoplastic cover and plate provide outstanding impact resistance and durability
- UL 94 VO Flammability Rating
- IP 64 Suitability rating protects against dust particles and splashing water
- NEMA Type-3R enclosure Rating ensures protection against rain, sleet and damage from external ice formations
- Available with standard wire wells or with slots that accept fork terminals
- Dual gaskets, one under plate and one under lid, for weather-resistant fit
- Stainless steel external hardware resists corrosive effects of moisture
- Large thumb-tab makes it easy to open cover with gloved hand
- Mounts to panels or FS/FD boxes
- UL Listed and CSA Certified for wet locations with cover closed

TESTING & CODE COMPLIANCE

- UL Listed (File # E-13397)
- CSA Certified (File #LR-16347)
- NOM Certified (#057)
- IP 64 Suitability Rating (protected against dust and splashing water)
- NEMA Type-3R Enclosure Rating when properly installed (protected against rain, sleet and damage from external ice formations)
- Backed by a Limited 2-Year Warranty

MATERIAL CHARACTERISTICS

Environmental: VO Flammability Rating per UL 94
 Operating Temperature: -40°C to 75°C

