



Sold by:



# Straight Blade Plugs and Connectors

## 15 AMP 125V 2-Pole, 3-Wire Grounding Hospital Grade

DESCRIPTION	CAT. NO. PLUG NEMA 5-15P 	CAT. NO. CONNECTOR NEMA 5-15R 
Hospital Grade, Black Body	8215-C	8219-C
Hospital Grade, Transparent Body	8215-CT	8219-CT
Hospital Grade, Lighted Transparent	8215-PLC	8219-PLC
Hospital Grade Angle, Transparent Body	8215-CAT	—



### Industrial Grade

Black Nylon Body	5266-C	5269-C
High-Visibility Yellow Nylon Body	5266-CY	5269-CY
All-Black Nylon for Stage and Studio	5266-CB	5269-CB
All-Black Nylon, Lighted	5266-PLB	5269-PLB
Isolated Ground, Orange Body	5266-CO	5269-CO
Gray Nylon Body	5266-CG	5269-CG
Black Nylon Body, Lighted	5266-PLC	5269-PLC
Angle, Black Nylon Body	5266-CA	5269-CA
Black 2-Piece Nylon Shell	5266-N	5269-N
Flanged Inlet, White Nylon Body	5278-C	—
Flanged Outlet, White Nylon Body	—	5279-C

### Factory-Assembled Cord Sets—15 AMP 125V 2-Pole, 3-Wire Grounding

DESCRIPTION	CAT. NO. 14/3 SOOW Yellow Cord B & W Devices	CAT. NO. 12/3 SOOW Yellow Cord B & W Devices	CAT. NO. 12/3 SEOW Black Cord, Lighted Transparent Devices
25' Industrial Grade★	I515-43A	I515-23A	—
50' Industrial Grade★	I515-43B	I515-23B	—
100' Industrial Grade★	I515-43C	I515-23C	—
25' Hospital Grade★	—	—	HGPLC-25

## 15 AMP 250V 2-Pole, 3-Wire Grounding Industrial Grade

DESCRIPTION	CAT. NO. PLUG NEMA 6-15P 	CAT. NO. CONNECTOR NEMA 6-15R 
Black Nylon Body	5666-C	5669-C
High-Visibility Yellow Nylon Body	5666-CY	5669-CY
Angle, Black Nylon Body	5666-CA	—
Flanged Inlet, White Nylon Body	15678-C	—
Flanged Outlet, White Nylon Body	—	15679-C

All devices are UL Listed. Also CSA Certified except where indicated by★

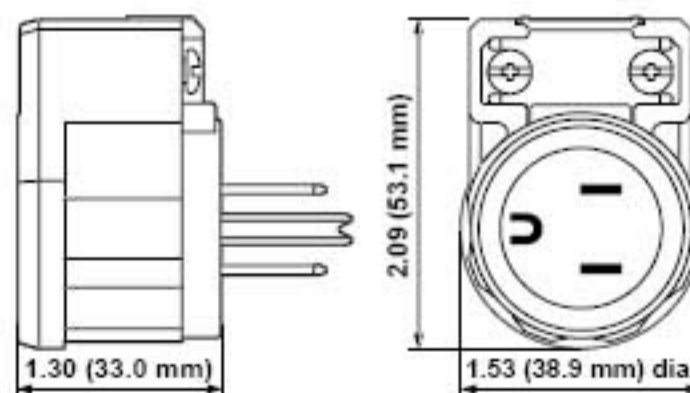
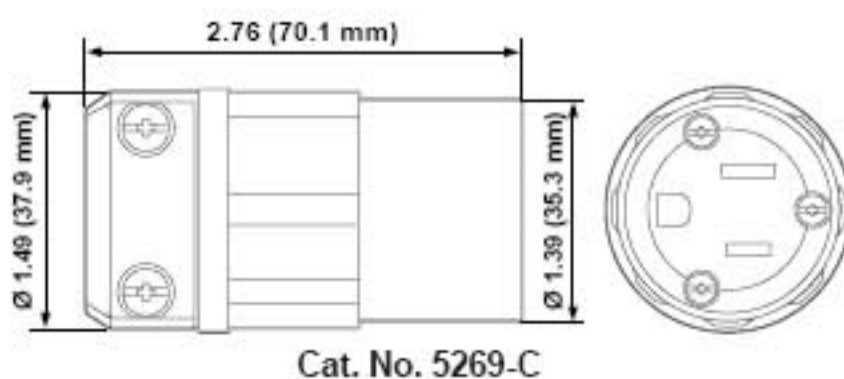
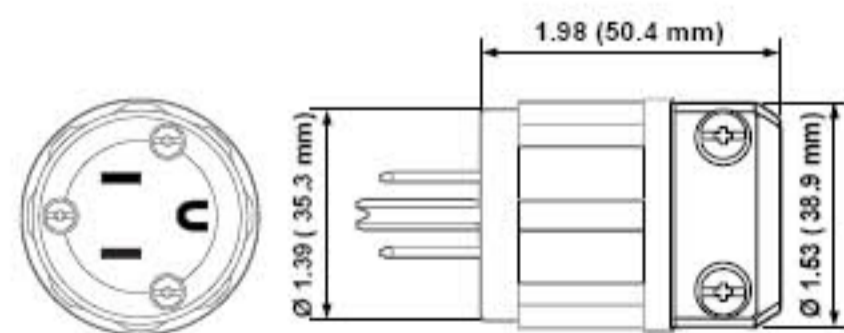

### SPECIFICATIONS & FEATURES

#### Hospital Grade

- Unmatched quality and performance confirmed by rigorous UL 498 testing
- Clearly identified by green dot

#### Industrial Grade

- Rugged construction resists impact, sunlight, chemicals and rough use
- All contacts are solid one-piece brass for better conductivity
- Triple-wipe, heavy-duty power contacts set in deep pockets to resist damage
- Captive, color-coded brass #8 terminal screws
- Unique cord clamp accepts wide range of cable sizes, grips securely without tearing cord jackets: 10-3ST-18-3SVT (.245"- .700" OD)

### TESTING & CODE COMPLIANCE

- Meet NEMA WD 1 & 6, ANSI requirements
- UL Listed & meets UL Fed. Spec. requirements: Industrial Plugs & Connectors (File #13393); Hospital Grade (UL 498, File #E-13393)
- CSA Certified (File #LR-406)
- NOM Certified (#057)
- Backed by a Limited 10-Year Warranty

### MATERIAL CHARACTERISTICS

Environmental: Flammability, Rated V2  
Operating Temperature: -40°C to 65°C

For more information regarding corrosion-resistant devices refer to Corrosion Resistant Devices, Section K.