





### Advantages of All Leviton Nylon Wallplates

- Molded nylon for maximum resistance to impact, abrasion, grease, oils, acids, moisture, fading and discoloration
- Resistant to mechanical stress associated with high abuse applications
- Includes metal mounting screws that match plate color
- Commercial grade devices backed by a Limited 10-Year Warranty

## Standard Size

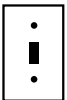
### Commercial Grade Nylon Wallplates

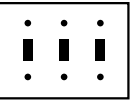
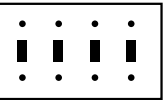
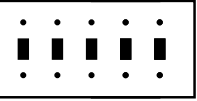
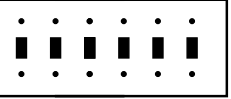
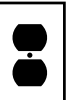
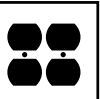
DESCRIPTION	COLOR	CAT. NO.	IND. NO.
<b>1-GANG 1-Toggle</b> 	IVORY	80701-I	N1-I
	BLACK	80701-E	N1-BK
	GRAY	80701-GY	N1-GRY
	RED	80701-R	N1-RED
	WHITE	80701-W	N1-W
	BROWN ALMOND	80701 80701-A	N1 N1-A
<b>2-GANG 2-Toggles</b> 	IVORY	80709-I	N2-I
	BLACK	80709-E	N2-BK
	GRAY	80709-GY	N2-GRY
	RED	80709-R	N2-RED
	WHITE	80709-W	N2-W
	BROWN ALMOND	80709 80709-A	N2 N2-A
<b>3-GANG 3-Toggles</b> 	IVORY	80711-I	N3-I
	BLACK	80711-E	N3-BK
	GRAY	80711-GY	N3-GRY
	RED	80711-R	N3-RED
	WHITE	80711-W	N3-W
	BROWN ALMOND	80711 80711-A	N3 N3-A
<b>4-GANG 4-Toggles</b> 	IVORY	80712-I	N4-I
	GRAY	80712-GY	N4-GRY
	RED	80712-R	N4-RED
	WHITE	80712-W	N4-W
	ALMOND	80712-A	N4-A
<b>5-GANG 5-Toggles</b> 	IVORY	80723-I	N5-I
	WHITE	80723-W	N5-W
	ALMOND	80723-A	N5-A
<b>6-GANG 6-Toggles</b> 	IVORY	80736-I	N6-I
	WHITE	80736-W	N6-W
<b>1-GANG 1-Duplex</b> 	IVORY	80703-I	N8-I
	BLACK	80703-E	N8-BK
	GRAY	80703-GY	N8-GRY
	RED	80703-R	N8-RED
	WHITE	80703-W	N8-W
	BROWN	80703	N8
	ORANGE	80703-ORG	N8-ORG
	BLUE	80703-BU	N8-BU
	ALMOND	80703-A	N8-A
	<b>2-GANG 2-Duplex</b> 	IVORY	80716-I
BLACK		80716-E	N82-BK
GRAY		80716-GY	N82-GRY
RED		80716-R	N82-RED
WHITE		80716-W	N82-W
BROWN		80716	N82
ORANGE		80716-ORG	N82-ORG
BLUE		80716-BU	N82-BU
ALMOND		80716-A	N82-A

All devices are UL Listed and CSA Certified.

### Single-Gang Standard Size Duplex Wallplates

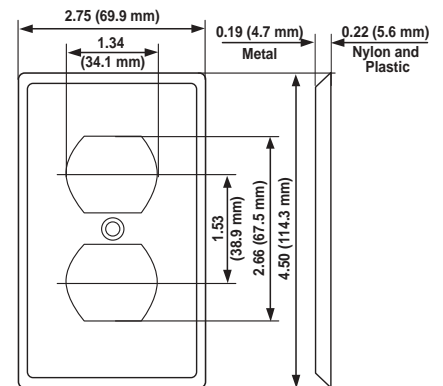

For more information regarding matching wallplates, colors, materials, single and multi-gang, refer to Decora Devices, Section A, and Decora Home Controls, Section B.