

**COMBINATION COVER  
& CARPET FLANGE**  
Including Floor Box Products  
UL Listed

# HUBBELL



*Wiring Device-Kellems, Hubbell Incorporated is a registered ISO 9002 Company.*





# Combination Cover & Carpet Flange

## Hubbell Floor Boxes

UL Listed



SF3925



SF2925



SF2725



SF2525

### Features

- Floor box cover with integral carpet flange.
- All brass unit is a full 6 1/4 inches in diameter.
- Units are gasketed to keep out scrub water.
- Catalog number SF3925 has self-closing flaps.

### Benefits

- Combines flush floor box cover and carpet flange into one unit:
  - Neat appearance
  - Easy to install
- Brushed brass provides an elegant look and 6 1/4 inch diameter ensures that carpet is held down and trimout imperfections are hidden.
- UL listed for both carpet and tile floor applications.
- Duplex flaps automatically close when not in use. Prevents breakage, reduces trip hazard.

## Specification Data

### Typical Specifications

**Description:** Floor box cover with integral carpet flange.

**Construction:** Forged brass.

**Finish:** Brushed and lacquered.

**Diameter:** 6 1/4 inches.

**Application:** Used on round Hubbell floor boxes listed on next page.

**NOTE:** Intended for single-service applications (power or voice data).

**Floor Surface:** Carpet or tile floor surfaces.

**UL Data:** UL listed 232A, UL file no. E31999

## Ordering Information

Catalog No.	Description	Catalog No.	Description
SF3925	With duplex flaps.	SF2725	With combination 2 1/8 inch cap ring and 1 inch flush plug.
SF2925	With 2 1/8 inch threaded plug (for single receptacle).	SF2525	With combination 2 1/8 inch cap ring and 3/4 inch flush plug.

Sold by:



Wiring Device-Kellems











# Selection Chart

## Round Floor Boxes

UL Listed

### STEP 1

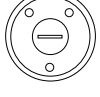
Select category of floor box covers (Options A or B).

OPTION A	OPTION B	
COMBINATION COVER & CARPET FLANGE (BRASS ONLY)	INDIVIDUAL COVER & CARPET FLANGE	
<p><b>Configurations</b> Diameter: 6 1/4"</p> <p>Duplex Flap Cat. No. SF3925</p>  <p>2 1/8" for Single Receptacle Cat. No. SF2925</p>  <p>Combination 2 1/8" x 1" Cat. No. SF2725</p>  <p>Combination 2 1/8" x 3/4" Cat. No. SF2525</p> 	<p><b>Flush Covers (Metallic)</b></p> <p><b>Configurations</b> Diameter: 3 7/8"</p> <p>Duplex Flap</p>  <p>Duplex Screw 1 1/2" &amp; 1 1/2"</p>  <p>Combination 2 1/8" x 1"</p>  <p>Combination 2 1/8" x 3/4"</p>  <p><b>Catalog No.</b></p> <p><b>Brass:</b> S3925    S3725    S2725    S2525</p> <p><b>Aluminum:</b> SA3925    SA3725    SA2725    SA2525</p> <p>2 1/8" For Single Receptacle</p>  <p>2 3/8" For Single Receptacle</p>  <p>2 1/8" Single (Terrazzo floors)</p>  <p><b>Catalog No.</b></p> <p><b>Brass:</b> S2925    S3525    S3325</p> <p><b>Aluminum:</b> SA2925    —    —</p>	<p><b>Carpet Flanges</b></p> <p><b>Configurations</b></p>  <p><b>Catalog No.</b> Diameter: 6 1/4"    5 1/4"</p> <p><b>Brass:</b> S3082    S3182</p> <p><b>Aluminum:</b> —    SA3182</p> <p><b>Clear Polycarbonate:</b> —    S3079</p> <p>NOTE: Use the above carpet flanges with covers listed to the left (if a carpet flange is required).</p>

### STEP 2

NOTE: All covers listed above are suitable for use on tile and carpet floors

Choose appropriate floor box (Options C, D, E, or F).

Open page for detailed product information on round floor boxes.

FLOOR BOXES							
<b>OPTION C</b>		<b>OPTION F</b>					
<b>Cast Iron (Fully Adjustable)</b>		<b>Plastic (Cut to Required Height)</b>					
<b>Catalog No.</b>		<b>Catalog No.</b>					
Brass Ring:	B2506    B2519    B2520 B2536    B2537	PFB1					
Aluminum Ring:	BA2536    BA2537	<ul style="list-style-type: none"> <li>Each PFB1 plastic floor box requires a PFBA1 adapter</li> <li>Trim ring required for each PFB1 when using covers listed above (exception: when using S3082 carpet flange)                             <table border="0" style="margin-left: 20px;"> <tr> <td>Brass Trim Ring:</td> <td>Cat. No. S5016</td> </tr> <tr> <td>Aluminum Trim Ring:</td> <td>Cat. No. SA5016</td> </tr> </table> </li> <li>It is not recommended to use the PFB1 with 5 1/4" dia. carpet flanges</li> <li>For multi-service applications (power &amp; voice/data in one PFB1 floor box), order SF39253 brass cover &amp; flange and PFBT1 low-voltage divider</li> </ul>		Brass Trim Ring:	Cat. No. S5016	Aluminum Trim Ring:	Cat. No. SA5016
Brass Trim Ring:	Cat. No. S5016						
Aluminum Trim Ring:	Cat. No. SA5016						
<b>OPTION D</b>							
<b>Stamped Steel (Fully Adjustable)</b>							
<b>Catalog No.</b>							
Brass Ring:	B2527    B2529						
Aluminum Ring:	BA2527    BA2529						
<b>OPTION E</b>							
<b>For Wooden Floors (Nonadjustable)</b>							
<b>Catalog No.</b>							
Brass Ring:	B2588    B2588275						
Aluminum Ring:	BA2588						



# Technical Data

## Round Floor Boxes

UL Listed

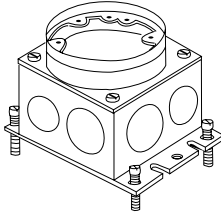
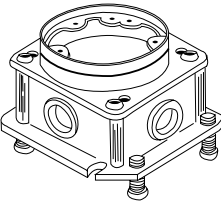
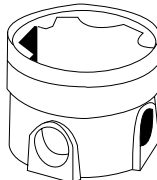
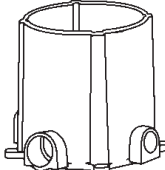

Description		Floor Box Catalog No.	
	<input type="checkbox"/> <b>Stamped Steel (Fully Adjustable)</b>		
		<b>Min. Depth of Pour</b>	<b>Brass Trim Ring</b>
		<b>Aluminum Trim Ring</b>	
	Deep	4"	B2527
	Shallow	3"	B2529
	<input type="checkbox"/> <b>Cast Iron (Fully Adjustable)</b>		
	Deep	3 3/4"	B2536
	Deep	3 3/4"	B253621
	Deep	3 3/4"	B253641
	Shallow	3"	B2537
	Deep	5"	B2506
	Deep	3 3/4"	B2503
	Deep	3"	B2519
	Shallow	3"	B2520
		<input type="checkbox"/> <b>Cast Iron (Nonadjustable) For Wood Floors</b>	
			B2588
			B2588275
	<input type="checkbox"/> <b>Plastic (Cut To Required Height)</b>		
	NOTES:	• Each PFB1 floor box requires a PFBA1 adapter.	PFB1
	• Order S5016 or SA5016 trim ring separately.	S5016	SA5016





## For Concrete Floors

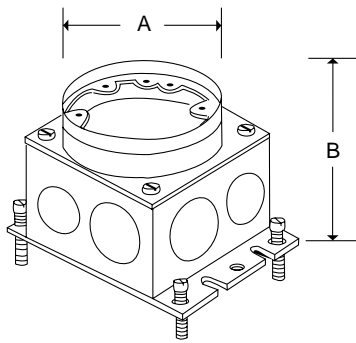

## For Wood Floors

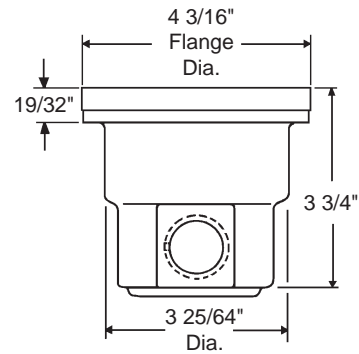

### Product Information

Dimensions A	B*	Cubic Inch Capacity	Before Pour External Height Adjustment	After Pour External Height Adjustment	Threaded Conduit Hub Size	Knockouts		
						Opposite Sides	Opposite Ends	Bottom
4 3/16"	3 7/8"	54.0"	1 1/4"	3/8"	—	one 1" & one 3/4"	one 1 1/4" & one 1/2"	three 1/2" & two 3/4"
4 3/16"	2 29/32"	37.3"	1 1/4"	3/8"	—	two 1/2" & one 3/4"	one 1/2" & one 3/4"	three 1/2" & two 3/4"
4 3/16"	3 3/32"	33.0"	1 1/4"	3/8"	3/4" four way	—	—	—
4 3/16"	3 3/32"	33.0"	1 1/4"	3/8"	two 3/4" & two 1"	—	—	—
4 3/16"	3 3/32"	33.0"	1 1/4"	3/8"	1" four way	—	—	—
4 3/16"	2 13/16"	30.0"	1 1/4"	3/8"	3/4" four way	—	—	—
4 3/16"	4 3/4"	50.8"	—	5/8"	1 1/4" four way	—	—	—
4 3/16"	3 3/4"	36.0"	—	5/8"	3/4" four way	—	—	—
4 3/16"	3"	20.0"	—	5/8"	3/4" four way & two 3/4" bottom	—	—	—
4 3/16"	2 5/8"	16.8"	—	1/4"	3/4" four way & two 3/4" bottom	—	—	—
4 3/16"	3 3/4"	18.5"	—	—	two 1/2" on bottom	—	—	—
4 3/16"	3 3/4"	18.5"	—	—	two 3/4" opp. sides, two 1/2" on bottom	—	—	—
5 3/4"	6.0"	100.0"	—	—	two 1" opp. sides, two 3/4" opp. sides**	—	—	—

\* 'B' represents the minimum dimension without base screws

\*\* Includes reducers – (2) 1" to 3/4"  
(2) 3/4" to 1/2"









# Selection Chart

## Rectangular Floor Boxes

UL Listed



### STEP 1

Select cover.

FLUSH COVERS					
<b>Configurations</b>					
Diameter: 3" x 4 3/8"					
					
Combination 2 1/8" x 3/4"	Combination 2 1/8" x 1"	Duplex Flap	Duplex Screw 1 1/2" x 1 1/2"	2 1/8" for Single Receptacle	2 3/8" for Single Receptacle
<b>Catalog No.</b>					
<b>Brass:</b>					
S2425	S2625	S3825	S3625	S2825	S3425
<b>Aluminum:</b>					
SA2425	SA2625	SA3825	SA3625	—	—
<b>Application:</b>					
Suitable for use on tile or carpeted floors					

### STEP 2

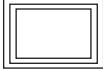
Select carpet flange if required.

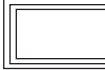
CARPET FLANGES		
<b>Configurations</b>		
		
1 Gang	2 Gang	3 Gang
<b>Catalog No.</b>		
<b>Brass:</b>		
SB3083	SB3084	SB3085
<b>Dimensions:</b>		
4 27/32" x 6"	8 2/32" x 6"	11 10/32" x 6"
<b>Clear</b>		
<b>Polycarbonate:</b>		
S3083	S3084	S3085
<b>Dimensions:</b>		
4 3/8" x 5 9/16"	7 9/16" x 5 9/16"	10 13/16" x 5 9/16"

### STEP 3

Select floor box (covers listed above will fit all floor boxes listed below).

FLOOR BOXES		
		
<b>Stamped Steel (Fully Adjustable)</b>		
<b>Configurations</b>	<b>Catalog No.</b>	
	<b>Brass Ring</b>	<b>Aluminum Ring</b>
1 Gang (Deep)	B2427	—
1 Gang (Shallow)	B2429	—
<b>Cast Iron (Fully Adjustable)</b>		
<b>Configurations</b>	<b>Catalog No.</b>	
	<b>Brass Ring</b>	<b>Aluminum Ring</b>
1 Gang (Deep)	B2436	BA2436
1 Gang (Shallow)	B2437	—
2 Gang (Deep)	B4233	BA4233
3 Gang (Deep)	B4333	BA4333
<b>Cast Iron (Semi-Adjustable)</b>		
<b>Configurations</b>	<b>Catalog No.</b>	
	<b>Brass Ring</b>	<b>Aluminum Ring</b>
1 Gang (Shallow)	B2414	—
2 Gang (Shallow)	B4214	—
3 Gang (Shallow)	B4314	—

For more information regarding additional Hubbell floor box products (including 3 Service Floor Box, Service Pedestals, and accessories), consult Catalog #101.



### Wiring Device - Kellems

Hubbell Incorporated (Delaware) • 185 Plains Road • Milford, CT 06460-2420 • (203) 882-4800 • FAX (800) 255-1031  
World Wide Web URL: <http://www.hubbell-wiring.com>

®Registered trademark of Hubbell Incorporated



H4441 Printed in U.S.A. Copyright 1993, Hubbell Incorporated  
Specifications Subject To Change Without Notice.