

TECHNICAL Practice

TELECOM SOLUTIONS FOR THE 21ST CENTURY

VC-1000
CCTV Camera
Controller
 February 28, 2006

Provide Event-Triggered CCTV Camera Switching for Two Zones - Expandable to Four



The **VC-1000** Programmable CCTV Camera Controller consists of two telco interface modules each linked to a CCTV camera input and a combiner for output to a video monitor, television or VCR.

Unlike passive or manual CCTV camera switchers, the **VC-1000** continuously monitors for activity on its telco line circuits and instantly switches to the appropriate camera when activity is detected.

During periods of inactivity, the **VC-1000** can be programmed to provide no video output, output camera 1, output the last camera activated, or output the cameras sequentially. Two **VC-1000**'s can be stacked to cover four zones. Programming is done easily using dip switches.

Phone...715.386.8861

Applications

Features

- Automatic, instant switching to activated camera
- Supports 2 zones/entry points, expandable to 4 entry points (requires 2 units)
- Compatible with analog PABX/KSU extensions, Viking doorboxes, entry phones, and emergency phones
- Screw terminals for easy connection
- Separate screw-terminal connections for camera power and ground
- Rugged, durable relay switching for video control
- Dip switch programming for modes and camera assignment
- Four inactive modes
- Activated by ringing or off-hook
- 12V 400mA DC output provided to operate two CCTV cameras
- Can be configured to activate from a doorbell

- Adds video switching capability to the following Viking products:

- **1600A Series** Emergency Phones
- **K-1900 Series** Phones
- **K-1500 Series** Phones
- **E-10, E-20A and E-30** Speaker Phones
- **W-1000, W-2000A and W-3000** Doorboxes

- Apartment entry
- Security checkpoints
- Multi-zone surveillance



<http://www.vikingelectronics.com>

Specifications

Power: 120V AC/13.8V AC, 1.25A UL listed adapter provided
Power Output: 12V 400mA DC (total, for both cameras)
Dimensions: 133mm x 89mm x 44mm (5.25" x 3.5" x 1.75")
Shipping Weight: .80 kg (1.7 lbs)
Environmental: 0° C to 32° C (32° F to 90° F) with 5% to 95% non-condensing humidity
Relay Contact Rating: 1A 30VDC, 0.3A 110 VDC, 0.5A 125VAC
Connections: (20) cage clamp screw terminals

IF YOU HAVE A PROBLEM WITH A VIKING PRODUCT, PLEASE CONTACT: VIKING TECHNICAL SUPPORT AT (715) 386-8666

Our Technical Support Department is available for assistance Monday 8am - 4pm and Tuesday through Friday 8am - 5pm central time. So that we can give you better service, before you call please:

1. Know the model number, the serial number and what software version you have (see serial label).
2. Have your Technical Practice in front of you.
3. It is best if you are on site.

RETURNING PRODUCT FOR REPAIR

The following procedure is for equipment that needs repair:

1. Customer must contact Viking's Technical Support Department at 715-386-8666 to obtain a Return Authorization (RA) number. The customer MUST have a complete description of the problem, with all pertinent information regarding the defect, such as options set, conditions, symptoms, methods to duplicate problem, frequency of failure, etc.
2. Packing: Return equipment in original box or in proper packing so that damage will not occur while in transit. Static sensitive equipment such as a circuit board should be in an anti-static bag, sandwiched between foam and individually boxed. All equipment should be wrapped to avoid packing material lodging in or sticking to the equipment. Include ALL parts of the equipment. C.O.D. or freight collect shipments cannot be accepted. Ship cartons prepaid to: **Viking Electronics, 1531 Industrial Street, Hudson, WI 54016**
3. Return shipping address: Be sure to include your return shipping address inside the box. We cannot ship to a PO Box.
4. RA number on carton: In large printing, write the R.A. number on the outside of each carton being returned.

RETURNING PRODUCT FOR EXCHANGE

The following procedure is for equipment that has failed out-of-box (within 10 days of purchase):

1. Customer must contact Viking's Technical Support at 715-386-8666 to determine possible causes for the problem. The customer MUST be able to step through recommended tests for diagnosis.
2. If the Technical Support Product Specialist determines that the equipment is defective based on the customer's input and troubleshooting, a Return Authorization (R.A.) number will be issued. This number is valid for fourteen (14) calendar days from the date of issue.
3. After obtaining the R.A. number, return the approved equipment to your distributor, referencing the R.A. number. Your distributor will then replace the product over the counter at no charge. The distributor will then return the product to Viking using the same R.A. number.
4. The distributor will **NOT** exchange this product without first obtaining the R.A. number from you. If you haven't followed the steps listed in 1, 2 and 3, be aware that you will have to pay a restocking charge.

WARRANTY

Viking warrants its products to be free from defects in the workmanship or materials, under normal use and service, for a period of one year from the date of purchase from any authorized Viking distributor or 18 months from the date manufactured, whichever ever is greater. If at any time during the warranty period, the product is deemed defective or malfunctions, return the product to Viking Electronics, Inc., 1531 Industrial Street, Hudson, WI, 54016. Customer must contact Viking's Technical Support Department at 715-386-8666 to obtain a Return Authorization (R.A) number.

This warranty does not cover any damage to the product due to lightning, over voltage, under voltage, accident, misuse, abuse, negligence or any damage caused by use of the product by the purchaser or others.

Viking's sole responsibility shall be to repair or replace (at Viking's option) the material within the terms stated above. VIKING SHALL NOT BE LIABLE FOR ANY LOSS OR DAMAGE OF ANY KIND INCLUDING INCIDENTAL OR CONSEQUENTIAL DAMAGES RESULTING DIRECTLY OR INDIRECTLY FROM ANY BREACH OF ANY WARRANTY EXPRESSED OR IMPLIED, OR FOR ANY OTHER FAILURE OF THIS PRODUCT. Some states do not allow the exclusion or limitation of incidental or consequential damages, so this limitation may not apply to you.

THIS WARRANTY IS IN LIEU OF ALL OTHER WARRANTIES, EXPRESSED OR IMPLIED, INCLUDING THE WARRANTIES OF MERCHANTABILITY AND FITNESS FOR A PARTICULAR PURPOSE, WHICH ARE HEREBY EXCLUDED BEYOND THE ONE YEAR DURATION OF THIS WARRANTY. Some states do not allow limitation on how long an implied warranty lasts, so the above limitation may not apply to you.

Installation

IMPORTANT: Electronic devices are susceptible to lightning and power station electrical surges from both the AC outlet and the telephone line. It is recommended that a surge protector be installed to protect against such surges. Contact Panamax at (800) 472-5555 or Electronic Specialists Inc. at (800) 225-4876.

A. Telco Wiring

The VC-1000 monitors for ringing and off-hook activity on two analog lines, doorboxes or entry phone circuits. Connect as shown in the following diagrams.

1. Using with Viking Doorboxes

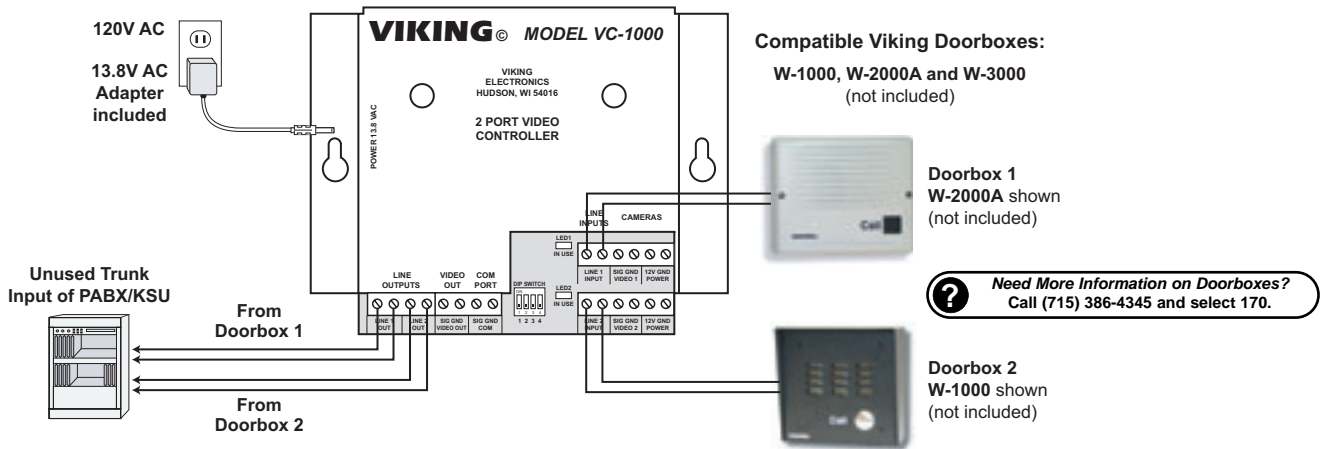

2. Using with Viking Entry Phones

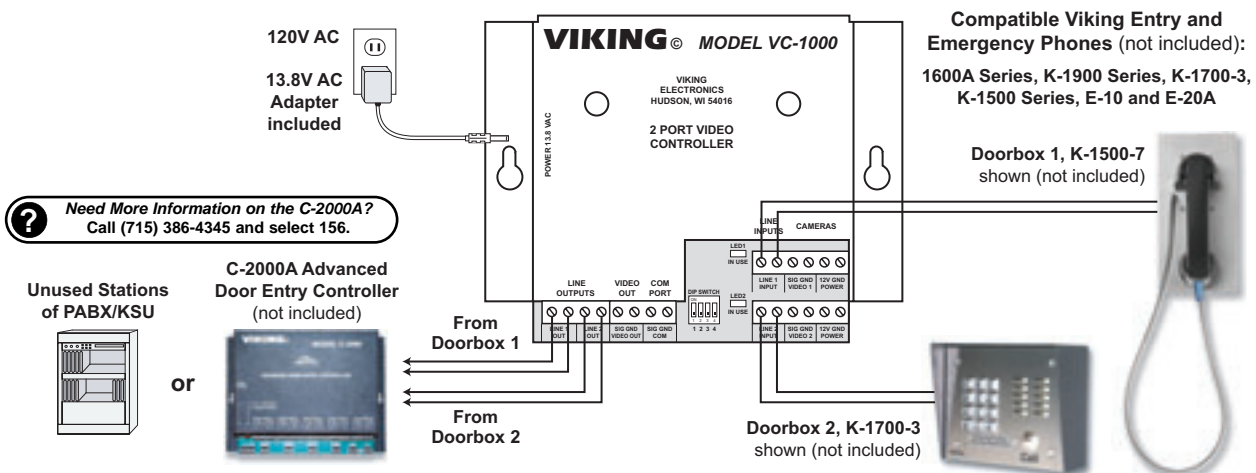

B. Video Wiring

Two video cameras can be wired to, and powered from, the **VC-1000** as shown below. A single video output can be wired directly to a video monitor/VCR, to the video input of a home television set, or to an RF modulator.

1. Industrial Application

Wire video signal directly to a TV / video monitor or video recorder as shown below.

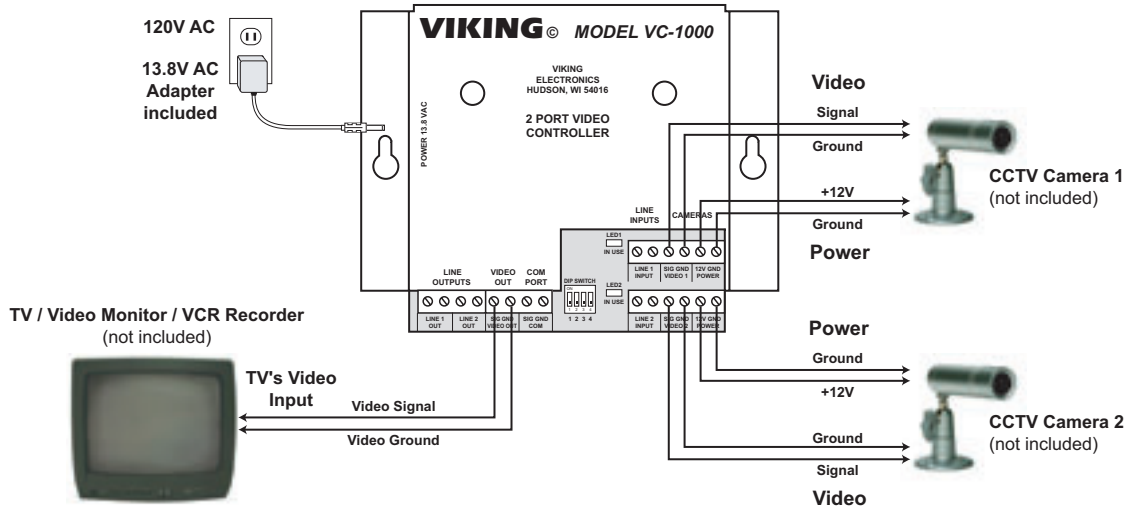

2. Home Application - Manual Switched Input

Wire video signal to home TV's video input. Manually switch to that input to see camera video.

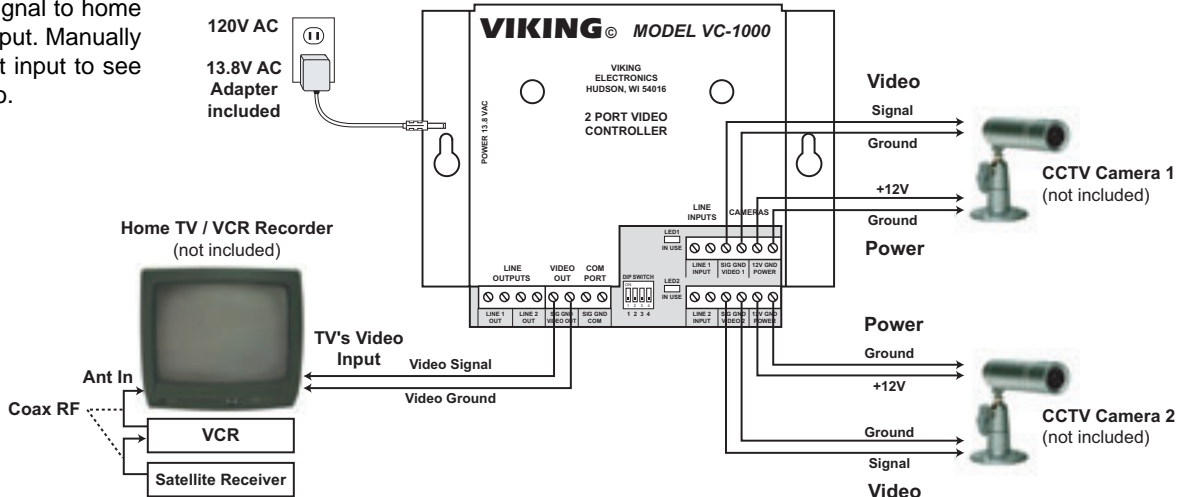

3. Home Application - Automatic Switched Input

Wire video signal to an inexpensive RF modulator (Radio Shack # 15-1214 or equivalent) that automatically switches from VCR/satellite to CCTV video when a signal is present. **Note:** For this application the TV must remain on channel 3 or 4. Set up the VCR and satellite receiver to send the signal out on channel 3 or 4 and use the VCR's tuner to select local broadcast stations.

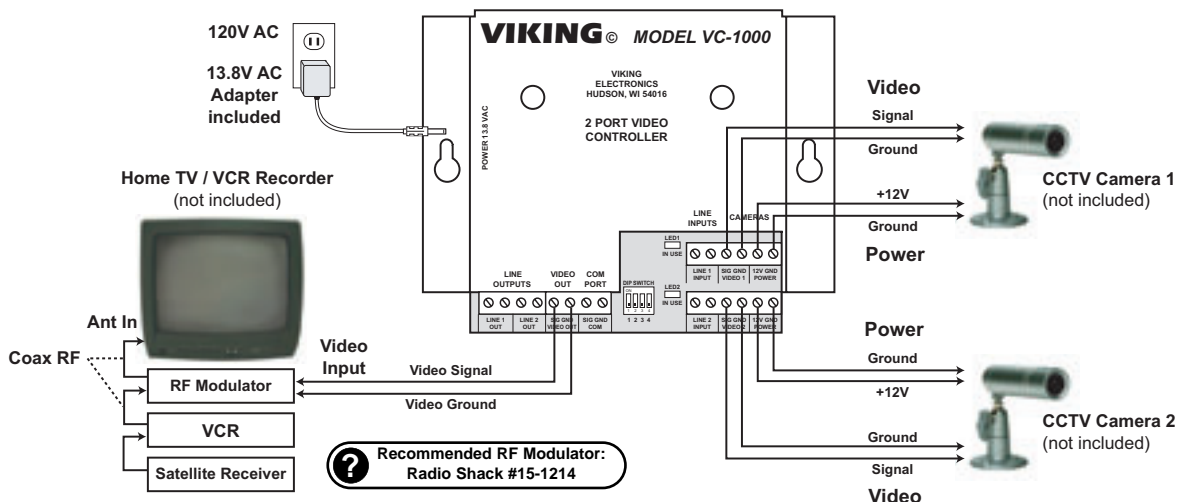

C. Gang Wiring

Two **VC-1000**'s can be wired together to support up to 4 zones/entry points. Do this by wiring the **COM PORT SIG** screw terminals together and wiring the **COM PORT GND** screw terminals together. The **VIDEO OUT** screw terminals of both **VC-1000**'s can be wired together in parallel to send video signal to a monitor TV or video recorder.

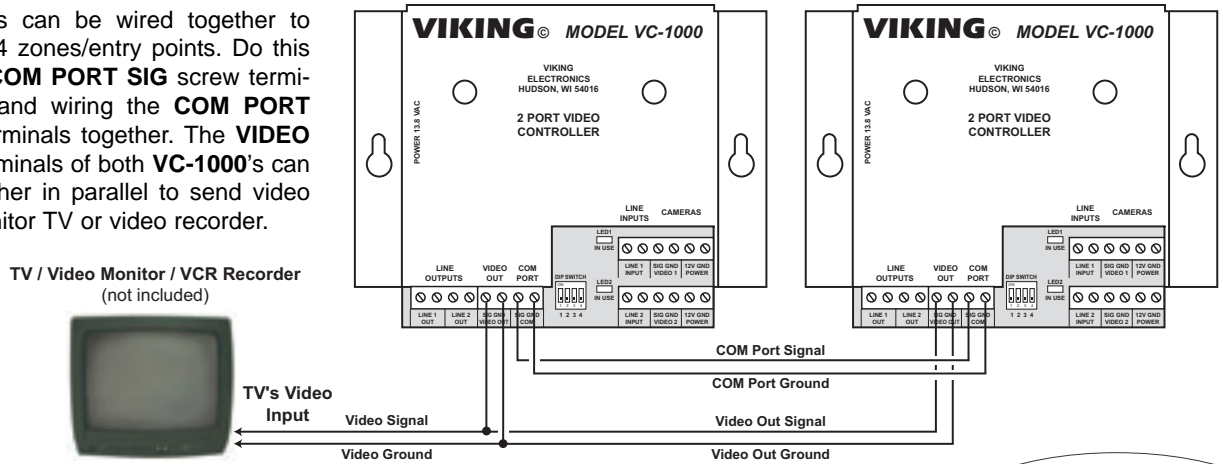

Programming



A. Camera Assignment for Sequenced Video Feature

Use DIP switches 1 and 2 to assign video camera 1 and video camera 2 in use, and off if not installed. The ability to turn off a camera position not being used will prevent the controller from sequencing in an unused camera position (see **Programming** section B).

Switch	ON/OFF	Description
1	ON	Camera 1 enabled
1	OFF	Camera 1 disabled
2	ON	Camera 2 enabled
2	OFF	Camera 2 disabled

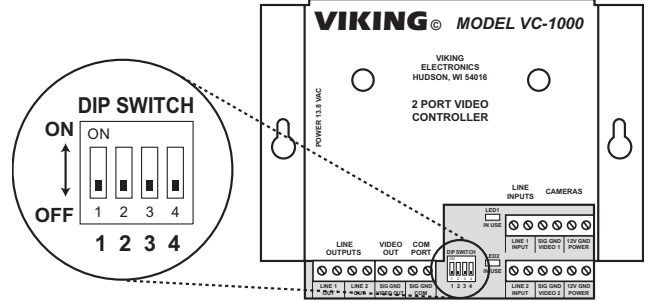

B. Inactive Modes

DIP switches 3 and 4 are used to program what the **VC-1000** does when all telco lines are inactive (not ringing or in-use). If "output camera 1" mode is used, an additional **VC-1000** ganged together must be set to "cameras disconnected" mode to prevent contentions. Otherwise, if two **VC-1000**'s are ganged together, both units must be programmed to the same inactive mode.

Switch 3	Switch 4	Description
OFF	OFF	All cameras are disconnected
OFF	ON	Output Camera 1 <i>Note: An additional VC-1000 ganged together must be set to "cameras disconnected".</i>
ON	OFF	Remain connected to the last camera activated, until another camera is called into action
ON	ON	Sequenced Video (rotate every 4 seconds)

Operation

The **VC-1000** allows multiple cameras to be concentrated down to one video signal, by switching to the camera at the zone/entry point being used. When the **VC-1000** detects ringing (voltage), off hook (loop current) of the entry phone or doorbox, or a doorbell button pressed, it will connect that camera's video feed to the video output. This happens in a first come, first serve manner. When all telco lines are idle (entry phones or doorboxes not in use), the **VC-1000** can be programmed to do one of four operations:

1. Disconnect all cameras so there is no video output. This mode is very convenient when used in combination with a video RF modulator, which automatically switches the video source in when a video signal is present. A home TV's broadcast/satellite program will be automatically interrupted to show video feed of the arriving guest (see **Installation** section C).
2. Connect video feed from camera 1.
3. Remain connected to the last camera active and continue feeding video from it until another camera is called into action.
4. Sequence video from all cameras connected, rotating every 4 seconds.

Product Support Line...715.386.8666

Fax Back Line...715.386.4345

Due to the dynamic nature of the product design, the information contained in this document is subject to change without notice. Viking Electronics, and its affiliates and/or subsidiaries assume no responsibility for errors and omissions contained in this information. Revisions of this document or new editions of it may be issued to incorporate such changes.