

MODULAR Y-ADAPTERS



Y-adapters are available as "splitters" which convert one 4-pair jack into two jacks. The Y-adapters utilize Siemon's patented UP-2468 plug which allows adapters to be used in 6- or 8-position jacks. The adapter body can be rotated 180° to view either the colored icons or the Y-adaptor pinouts, which are printed on the opposite side.



YU4-U2-U2

Splits a 4-pair USOC jack for Token Ring or voice applications at either jack

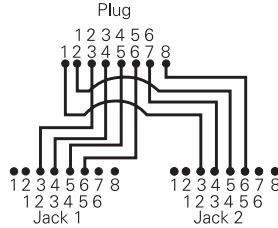

YA4-U2-U2

Splits a 4-pair T568B jack for Token Ring or voice applications at either jack

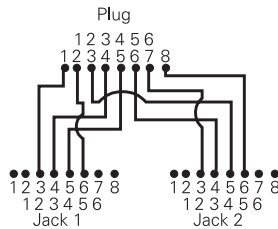

YT4-E2-E2

Splits a 4-pair T568A/T568B jack for 10BASE-T applications at either jack

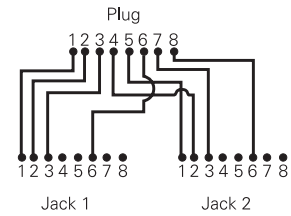

YT4-U2-U2

Splits a 4-pair T568A jack for Token Ring or voice applications at either jack

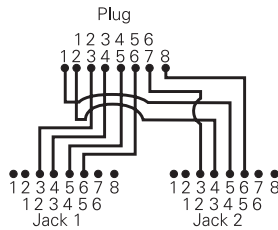

YA4-A3-U1

Splits a 4-pair T568B jack for 1-, 2- or 3-pair voice and 1-pair voice/modem

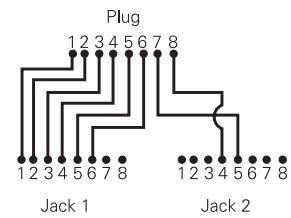

YT4-E2-U2

Splits a 4-pair T568A/T568B jack for 10BASE-T and Token Ring or voice applications

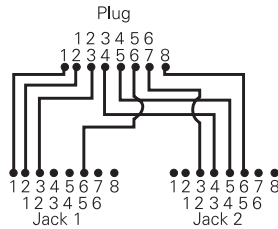

Y-BRIDGE

Bridges all jack pairs. Compatible with any jack wiring. Provides an additional 4-pair jack with the same wiring.

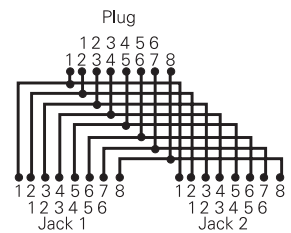

Note: These modular adapters meet category 3 transmission specifications.

MODULAR 4-WAY SPLITTER

Siemon's modular 4-way splitter provides provides access to each individual pair of a 4-pair modular outlet. The splitter converts a single 4-pair outlet to 4 individual 1-pair, 6-position outlets to enable four unique modular connections. The universal plug design enables compatibility with both 6- and 8-position outlets.

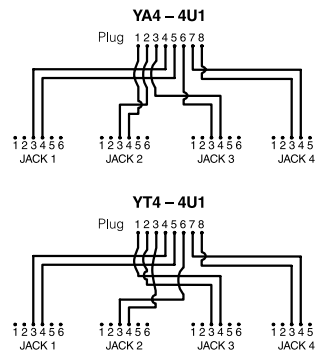

YA4-4U1 Modular 4-way splitter, T568B

YT4-4U1 Modular 4-way splitter, T568A

Sold by:

<http://www.TWAcomm.com>
Toll Free: (877) 892-2666