

Four Post Rack Adjustable Equipment Shelf

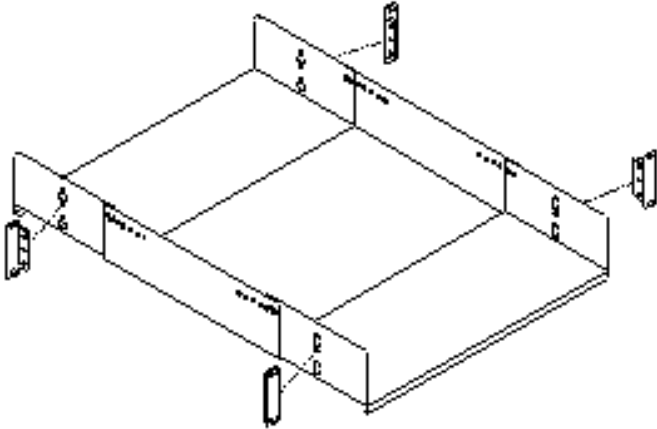

Features

- 19" four post relay rack mounting
- Formed construction for strength
- Shelves are adjustable from 27" to 32" deep
- 200 lb weight capacity per shelf
- Mounted to all four uprights

Specifications

- Sturdy 16 gauge steel construction
- Available in black powder coated finish

Ordering Information

SWE2732BLK Four Post Rack Adjustable
Equipment Shelf
(Fits Rack
SWE04-842732BLK)

Copyright © 2004 Southwest Data Products

