

2U

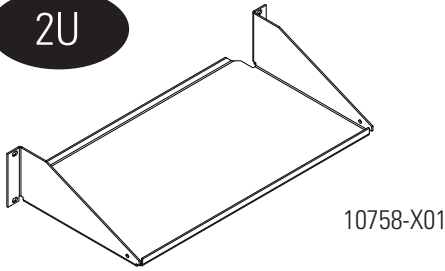

10758-X01

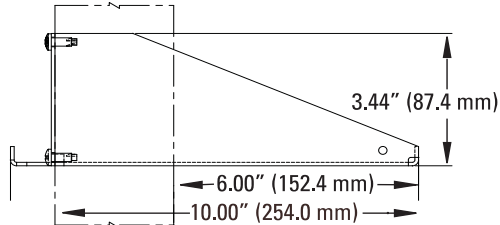

## Small Peripheral Shelf

Designed to hold small peripheral equipment in a central location. Each shelf typically holds two units and allows a convenient cable run down the inside of the rack channel. Mounting hardware not included. 19" rack mountable, holds equipment up to 17.35"W x 9.82"D (440.7 mm x 249.4 mm). Made of strong, lightweight aluminum, supports up to 50 lb (22.7 kg).

## Single-Sided Shelf

A convenient 15"D (380 mm) mounting shelf for miscellaneous equipment, test gear, etc. Mounting hardware not included. 19" version holds equipment up to 17.25"W x 14.82"D (438.2 mm x 376.4 mm), 23" version holds equipment up to 21.25"W x 14.82"D (539.8 mm x 376.4 mm). Made of strong, lightweight aluminum, supports up to 50 lb (22.7 kg). 19" version is UL Listed: File E140851; Category DUXR (US), DUXR7 (Canada) – Communications Circuit Accessory.

3U

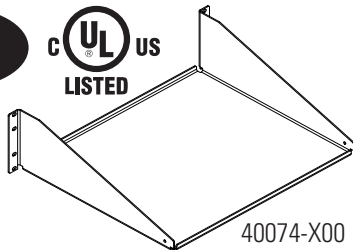

40074-X00

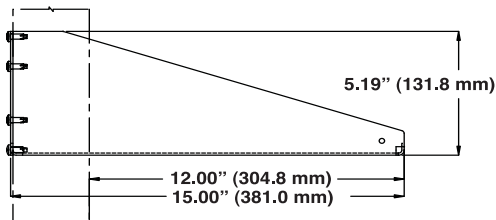

## Single-Sided Vented Shelf

Supports routers, switches, CPUs or any equipment requiring bottom ventilation. Mounting hardware not included. 19" version holds equipment up to 17.25"W x 14.82"D (438.2 mm x 376.4 mm), 23" version holds equipment up to 21.25"W x 14.82"D (539.8 mm x 376.4 mm). Wall, backboard or rack mountable. Made of strong, lightweight aluminum with airflow perforations, supports up to 50 lb (22.7 kg).

3U

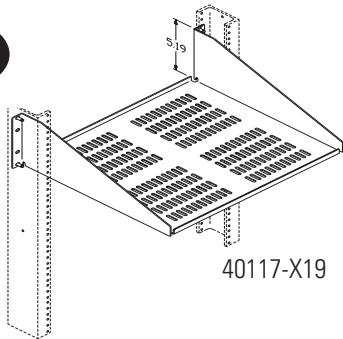

40117-X19

2U

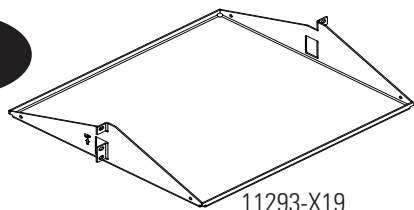

11293-X19

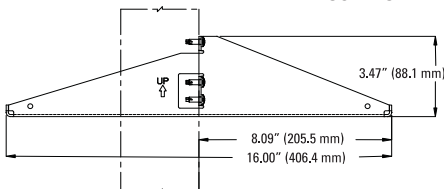

## 16"D (410 mm) Low Profile Shelf

Reduced height design saves on valuable rack space. Center mount design is ideal for single sided racks, mounts to either front or back of rack channel face. Mounting hardware not included. 19" version holds equipment up to 17.25"W x 15.82"D (438.2 mm x 401.8 mm), 23" version holds equipment up to 21.25"W x 15.82"D (539.8 mm x 401.8 mm). Made of strong, lightweight aluminum, supports up to 40 lb (18.1 kg).

Part Number	Description	Shipping Weight lb (kg)
10758-X01	Small Peripheral Shelf, 19"W	5 (2.3)
40074-X00	Single-Sided Shelf, For 19" Rack	6 (2.7)
40075-X00	Single-Sided Shelf, For 23" Rack	7 (3.2)
40117-X19	Single-Sided Vented Shelf, For 19" Rack	6 (2.7)
40118-X23	Single-Sided Vented Shelf, For 23" Rack	7 (3.2)
11293-X19	Low Profile Shelf, For 19" Rack	4 (1.8)
11293-X23	Low Profile Shelf, For 23" Rack	5 (2.3)

X=color: 1=Gray, 2=White, 5=Clear, 7=Black